

STOVES

MAKE A STATEMENT

USER GUIDE

A commitment to:



Countries of destination:

GB - Great Britain

IE - Ireland

DE - Germany

ES - Spain

FR - French

IT - Italy

PL - Poland

NL - Netherlands

SE - Sweden

CN - China

NZ - New Zealand

AU - Australia

To contact Stoves about your appliance, please call:



Customer Care Helpline

0344 815 3740

In case of difficulty within the UK



Warranty Registration

0800 952 1068

*Please call our Customer Care team for extended warranty



Spares Store

0344 815 3745



To register your appliance online:

www.stoves.co.uk



To contact us by email:

gdhainfo@gdha.com



To register your appliance by mail:

Please complete the warranty card and return to the address supplied



Alternatively general, spares and service information is available from our website at: **www.stoves.co.uk**

Calls are charged at the basic rate, please check with your telephone service provider for exact charges

Your new appliance comes with our **12-month guarantee**, protecting you against electrical and mechanical breakdown. To register, please complete the registration form included, register online or by phone. For full terms & conditions of the manufacturer's guarantee, please refer to the website above. In addition, you may wish to purchase an extended warranty. A leaflet explaining how to do this is included with your appliance.

Our policy is one of constant development and improvement, therefore we cannot guarantee the strict accuracy of all of our illustrations and specifications. Changes may have been made subsequent to publishing.

INTRODUCTION

Thank you for buying this British-built appliance from us.

This user guide book is designed to help you through each step of owning your new product.

Please read it carefully before you start using your appliance, as we have endeavored to answer as many questions as possible, and provide you with as much support as we can.

General information, spares and service information is available from our website.

If you should find something missing from your product or have any questions that are not covered in this user guide, please contact us (see contact information inside the front cover).

European Directives

As a producer and a supplier of cooking appliances we are committed to the protection of the environment and are in compliance with the WEEE directive. All our electric products are labelled accordingly with the crossed out wheeled bin symbol. This indicates, for disposal purposes at end of life, that these products must be taken to a recognized collection points, such as local authority sites/local recycling centres.



This appliance Complies with European Community Directives (CE) for household and similar electrical appliances and Gas appliances where applicable.

This appliance conforms to European Directive regarding Eco design requirements for energy-related products. Our policy is one of constant development and improvement, therefore we cannot guarantee the strict accuracy of all of our illustrations and specifications - changes may have been made subsequent to publishing.

Hereby, Glen Dimplex Home Appliances Ltd. declares that the radio equipment types ST RICH 600Ei is in compliance with Directive 2014/53/EU. The full text of the EU declaration of conformity is available at the following internet address: www.stoves.co.uk in the online user manual for this appliance.

Disposal of Packaging Material

The packaging materials used with this appliance can be recycled. Please dispose of the packaging materials in the appropriate container at your local waste disposal facilities.

UK ONLY GAS WARNING:

If you smell gas, Do not try to light any appliance. Do not touch any electrical switch.
Call the Gas Emergency Help line at **0800 111999**

SAFETY

WARNING

- If the hob surface is cracked, broken or shattered, switch off the appliance to avoid the possibility of electric shock and call for a service engineer's visit.
- During use the appliance becomes hot. Care should be taken to avoid touching heating elements.
- Children less than 8 years of age shall be kept away unless continuously supervised. This appliance can be used by children aged from 8 years and above and persons with reduced physical sensory or mental capabilities or lack of experience and knowledge if they have been given supervision or instruction concerning the use of the appliance in a safe way and understand the hazards involved. Children shall not play with the appliance. Cleaning and user maintenance shall not be made by children without supervision.
- Do not use harsh abrasive cleaners or sharp metal scrapers to clean the oven door glass since they can scratch the surface, which may result in shattering of the glass.
- Do not use a steam cleaner on any cooking range, hob or oven appliance.
- Metallic objects such as knives, forks, spoons and lids should not be placed on the hob surface since they can get hot.
- If your appliance is fitted with a lid, any spillage should be removed from the lid before opening. The hob surface should be allowed to cool before closing the lid (if fitted).
- After use, switch off the hob element by its control and do not rely on the pan detector.
- To avoid electric shock, ensure that the appliance is switched off before replacing the lamp.
- The appliance is not intended to be operated by means of an external timer or separate control system.
- Unattended cooking on a hob with fat or oil can be dangerous and may result in fire.
- NEVER try to extinguish a fire with water, but switch off the appliance and then cover the flame with a lid or damp cloth.

- Danger of fire: Do not store items on the cooking surfaces.
- Only use hob guards designed by the manufacturer of the cooking appliance or indicated by the manufacturer of the appliance in the instructions for use as suitable or hob guards incorporated in the appliance. The use of inappropriate hob guards can cause accidents.
- If the cooker is placed on a base, measures have to be taken to prevent the appliance slipping from the base.
- Never put items directly on the base of the oven or cover the oven with foil, as this can cause the base element to overheat.
- This induction hob complies with the applicable EMC and EMF standards. Therefore it should not interfere with other electronic units. Persons fitted with a pacemaker or any other electrical implant should clarify with their doctor or the producer of the implant, whether their implant is adequate and fail-safe. Please place pans centrally on the cooking zones. The British Heart Foundation provide additional advice regarding using induction hobs when a pacemaker is fitted.
- Do not place articles on or against the appliance.
- Always switch off your appliance and allow it to cool down before you clean any part of it.
- Although every care has been taken to ensure this appliance has no sharp edges, we recommend that you wear protective gloves when installing and moving this appliance. This will prevent injury.
- This appliance must be fitted to a switch providing all pole disconnection with a minimum contact separation of 3mm
- Connection should be made with a suitable flexible cable with a minimum temperature of 70°C.

CAUTION

- The cooking process has to be supervised. A short term cooking process has to be supervised continuously.
- This appliance must not be installed behind a decorative door in order to avoid overheating.
- Ensure shelving is correctly installed. See the sections on the shelf runners and shelf location within this book.

- **Fire Safety Advice**

If you do have a fire in the kitchen, don't take any risks - get everyone out of your home and call the Fire Brigade.

If you have an electrical fire in the kitchen:

- Pull the plug out, or switch off the power at the fuse box - this may be enough to stop the fire immediately
- Smother the fire with a fire blanket, or use a dry powder or carbon dioxide extinguisher
- Remember: never use water on an electrical or cooking oil fire.

- **Other Safety Advice**

- Servicing should be carried out only by authorised personnel.
- Do not operate the appliance without the glass panel correctly fitted.
- Do not modify the outer panels of this appliance in any way.
- This appliance must be earthed.
- The appliance must never be disconnected from the mains supply during use, as this will seriously affect the safety and performance, particularly in relation to surface temperatures becoming hot and gas operated parts not working efficiently. The cooling fan (if fitted) is designed to run on after the control knob has been switched off.
- **GAS WARNING!** - If you smell gas: Do not try to light any appliance, Do not touch any electrical switch. Contact your local gas supplier immediately.

USING YOUR APPLIANCE

Getting to know your product

Note: Your appliance layout may differ depending on the model.

Hob

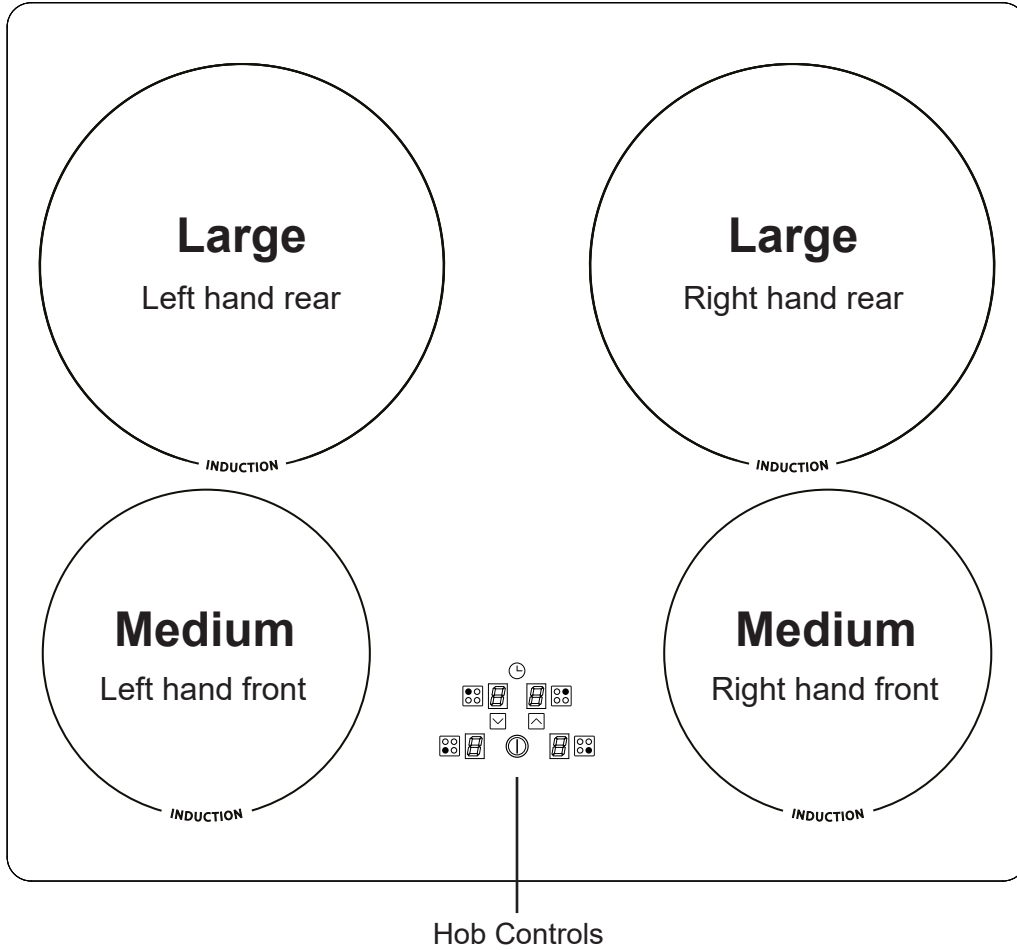

Control Panel

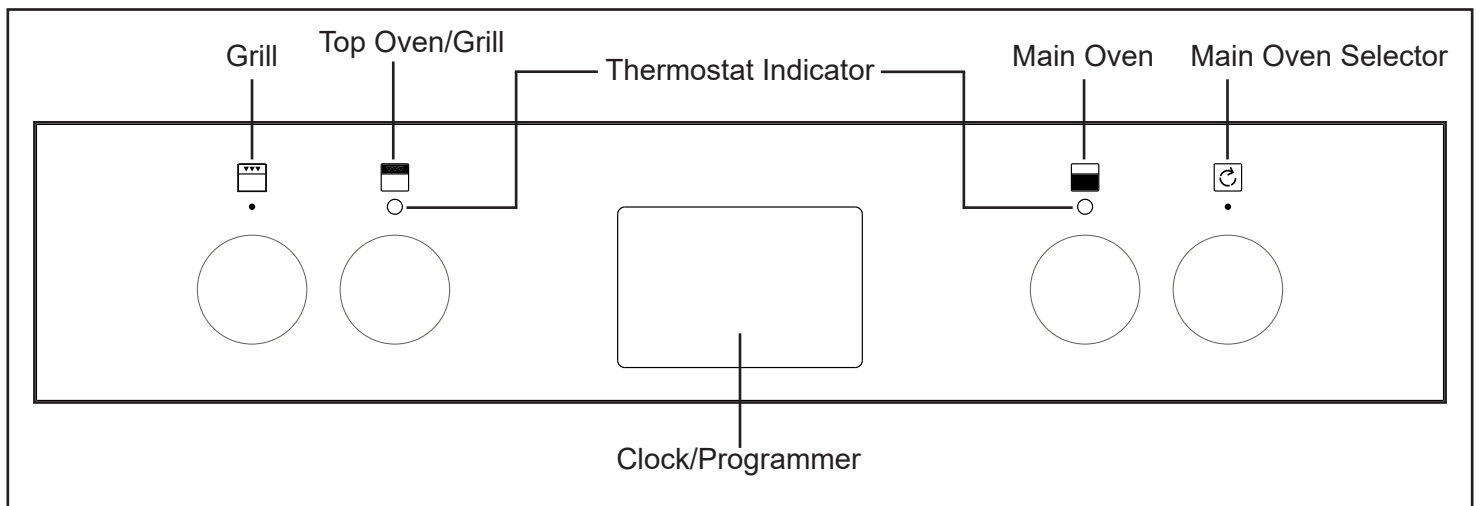

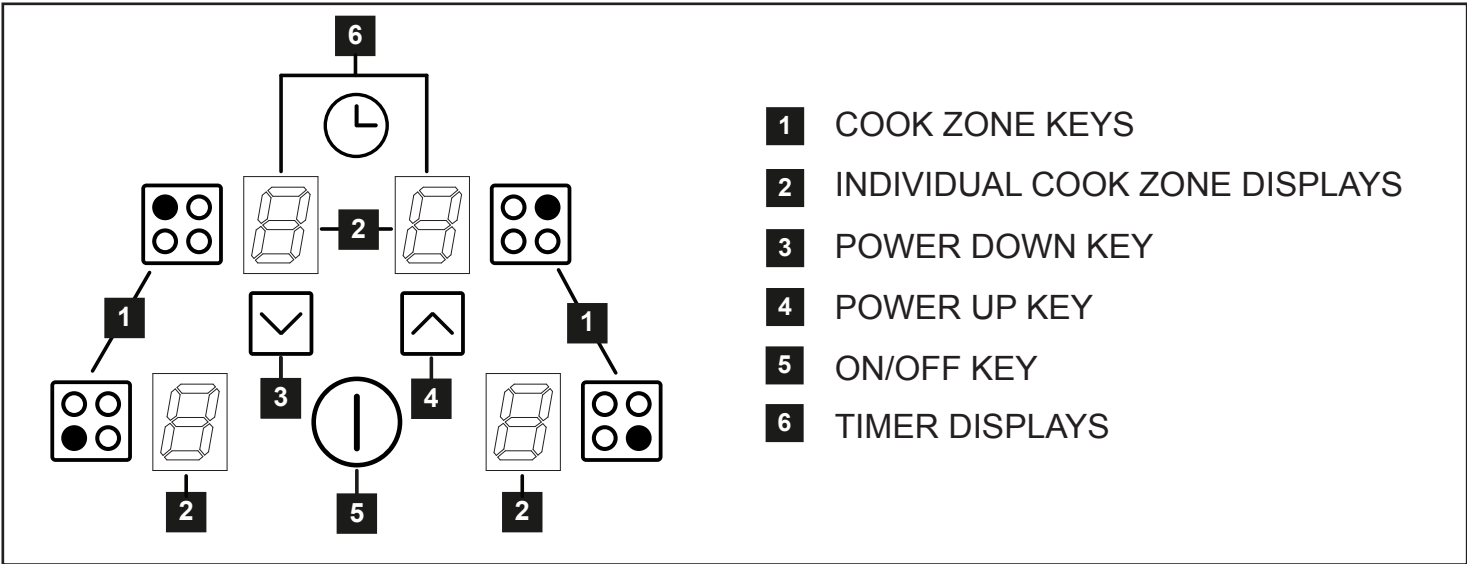

- 1** COOK ZONE KEYS
- 2** INDIVIDUAL COOK ZONE DISPLAYS
- 3** POWER DOWN KEY
- 4** POWER UP KEY
- 5** ON/OFF KEY
- 6** TIMER DISPLAYS

Appliance functions

Note: Your oven may not have all of the functions shown here. We recommend for best cooking results, please preheat your oven for 15 minutes and 3-5 minutes for grilling.

Do not try to slow cook using any of the other oven functions.



Intense Baking



Defrost



Base Heat with fan



Conventional Oven



Slow Cook



Fanned Oven



Fanned Grill



Low Grill



Oven Selector Control



Single Grill



Conventional Grill



Dual Grill

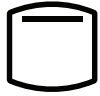

Top Heat



Base Heat



Lights only



Pizza Function



Bread Proving



Keep Warm

Grill

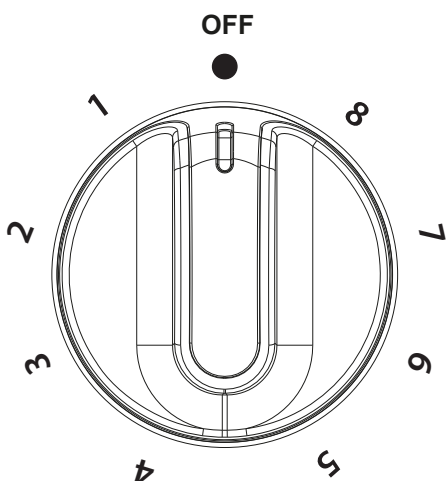

Top Oven/Grill

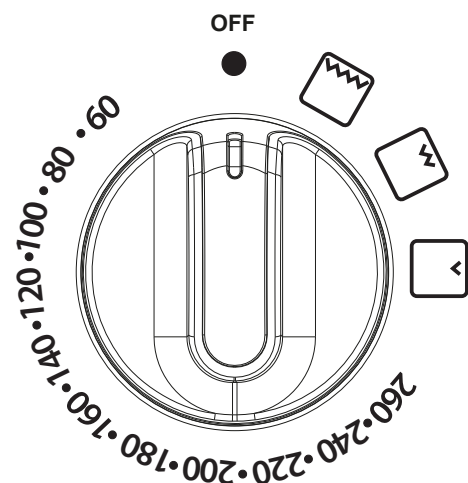

Main Oven

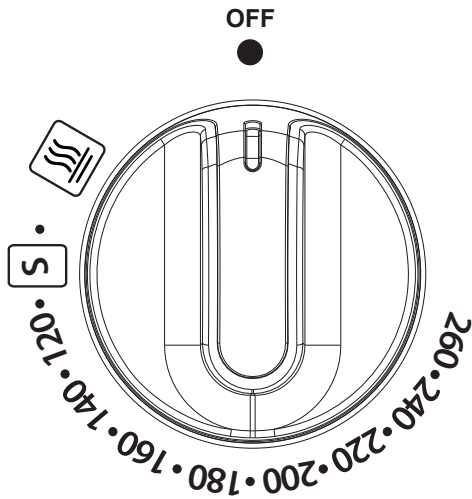

Oven Selector

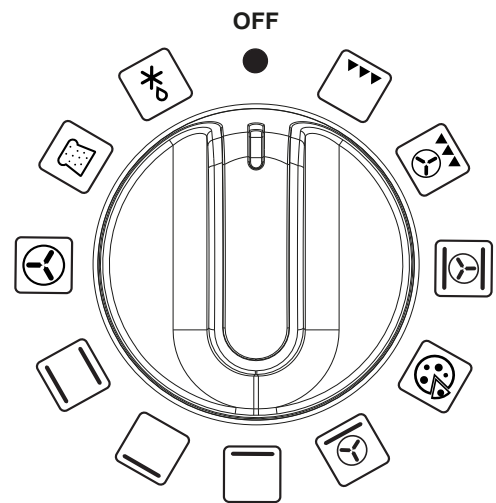

Note: The bread proving function can also be used as a defrost setting

Ovens and Grill

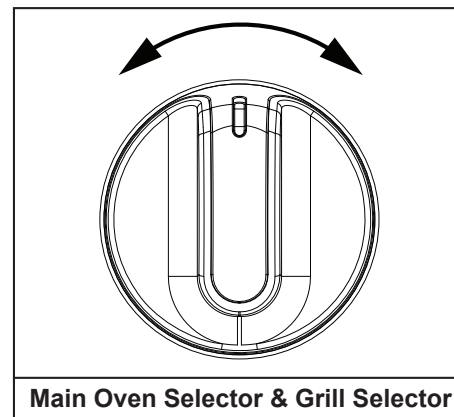
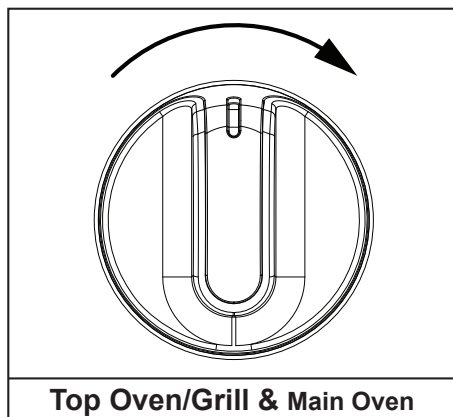

When using the top oven or main oven, the red thermostat indicator light will come on until the selected temperature is reached.

When the Top oven/grill or grill is switched on, the cooling fans come on to keep the fascia and control knobs cool during cooking/grilling. The cooking fans may operate when the main ovens are in use, depending on the temperature setting. The fans may continue to operate for a period after the oven/grill has been switched off. During use the fan may cycle on and off, this is normal.

Important: Never put items directly on the base of the oven, or cover the oven base with foil, as this may cause the element to overheat. Always position items on the shelf.

The main oven will not operate if the programmer is set to Auto, see clock/programmer section.

Top Oven - Grill

THE DOOR **MUST** BE OPEN WHEN THE GRILL IS USED FOR CONVENTIONAL GRILLING.

Main Oven - Grill



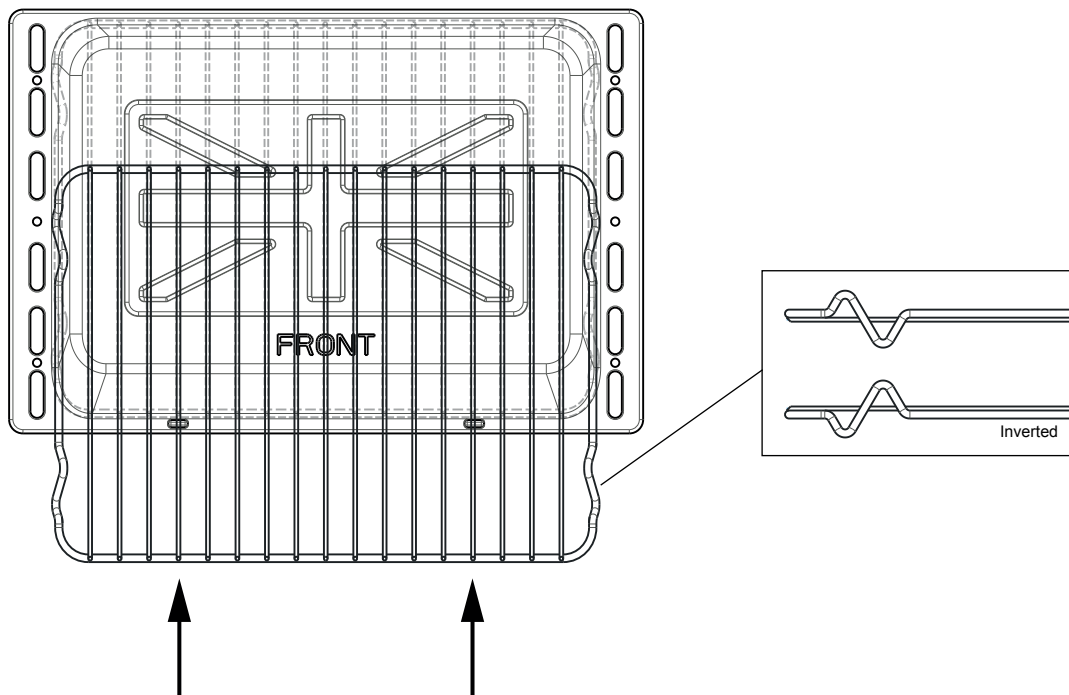

THE DOOR **MUST** BE CLOSED WHEN THE GRILL IS USED FOR FANNED CONVENTIONAL GRILLING.

Grill pan and trivet

The grill trivet (inside the grill pan) can be inverted to give a high or low position, or it may be removed. The speed of grilling can be controlled by selecting a higher or lower shelf position, or adjusting the grill setting.

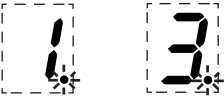

Hob Overview

| Function | Description | Symbol |
|------------------|--|---|
| Power Level | Once a cook zone is selected, a power level can be set to a low or high temperature. | 1-9 |
| Cook zone timer | Once a cook zone is selected, the cook zone timer can be activated to sound after a pre-determined amount of time. When the alarm sounds and the dot begins to flash. |  |
| Residual Heat | After use, the cooking surface remains hot and the residual heat symbol will be displayed. As it cools, the number of rings will reduce until they disappear from the display. |  |
| Pan detection | If no pan or an unsuitable pan is detected on an activated cook zone, the pan detection symbol will be displayed. Suitable pans - cast iron, metals with magnetic properties. Non-suitable pans - copper, stainless steel, aluminium, glass, ceramic, terra-cotta. |  |
| Booster function | The booster function temporarily increases the power to a cook zone allowing for a faster heat up time. It will deactivate automatically after 5 minutes or if a lower power level is selected. |  |
| Child lock | Child lock can be activated to stop the hob from being accidentally turned on. |  |

To switch the hob on

- 1** Touch and hold the on/off key for 1 second

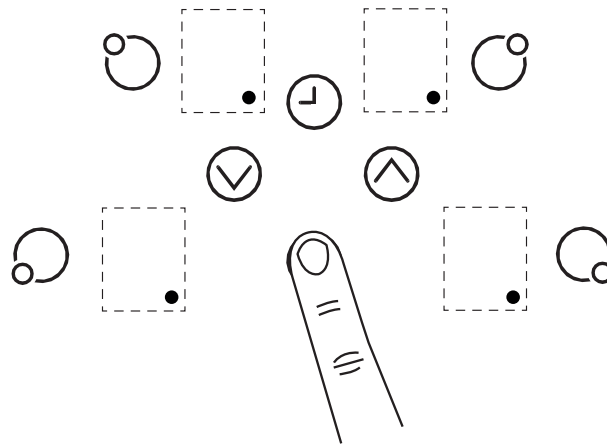

Note: If a zone is not selected in 10 seconds, the hob will turn off automatically.

Switching on an individual hob cook zone

- 1** Select desired cook zone

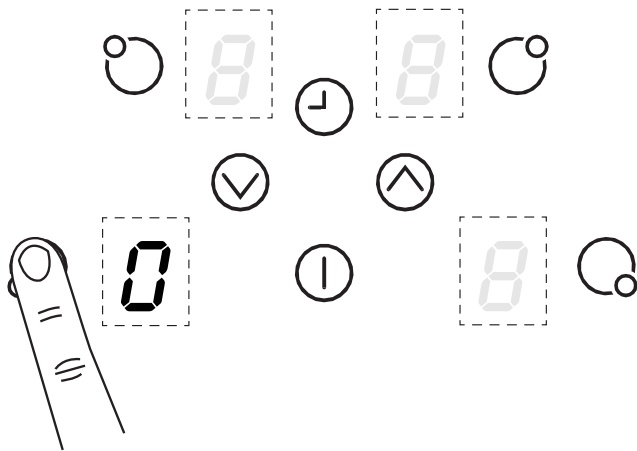

- 2** Use the up or down keys to select a power level

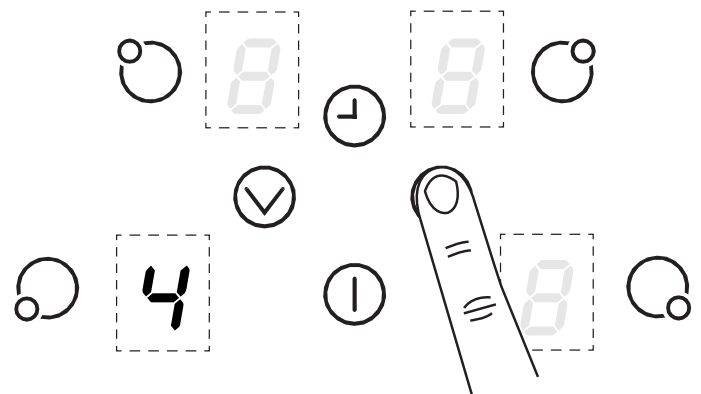

Pressing the minus key first selects power level 9.

When the cook zone selection is finished after 10 seconds, a beep sounds and all the zone displays that were dimmed show the power levels with normal brightness.

Switching off an individual hob cook zone

1 Select desired cook zone

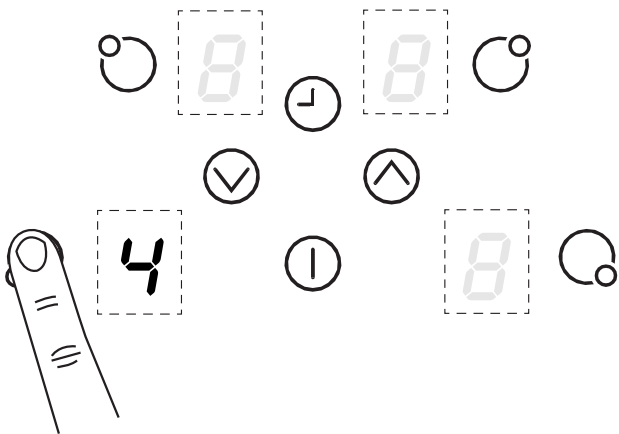

2 Touch the down key until 0 appears on the cook zone display

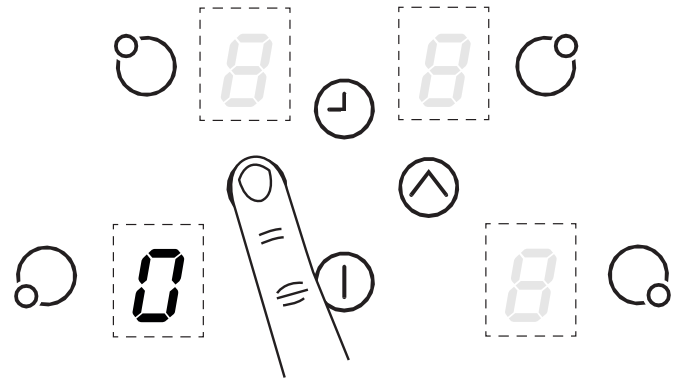

The selected cook zone will be switched off when the display shows "0".

Power boost (rear cook zones only)

1 Select desired rear cook zone

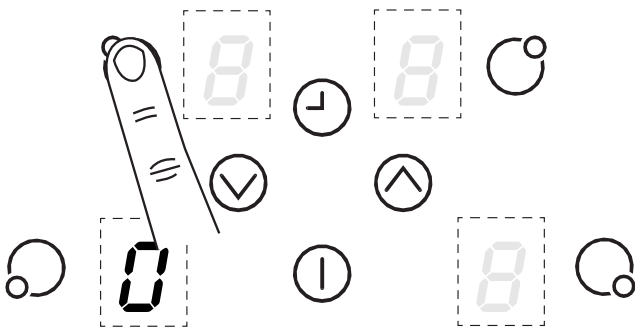

2 Touch the down key until power level 9 appears

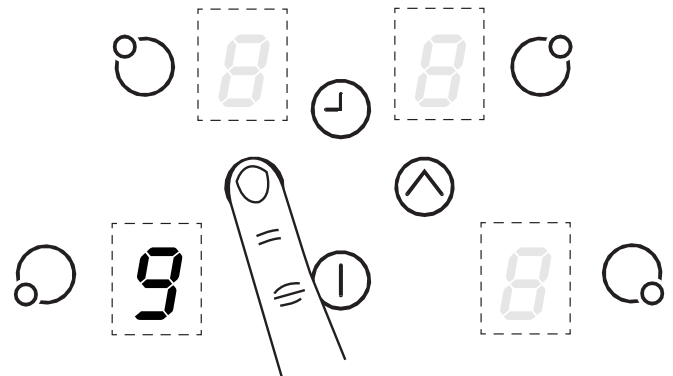

3 Touch the up key and the display will show power boost level

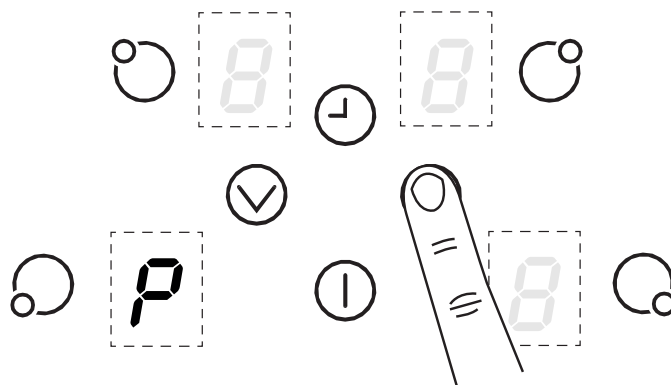

Note: With one rear cook zone set to boost, the power on the other rear zone is automatically limited to 8.

The cook zones can be boosted for a period of up to 5 minutes. When the Power Boost has finished, the zone will display power level 9.

Child Lock

- 1** Touch and hold the on/off key for 1 second

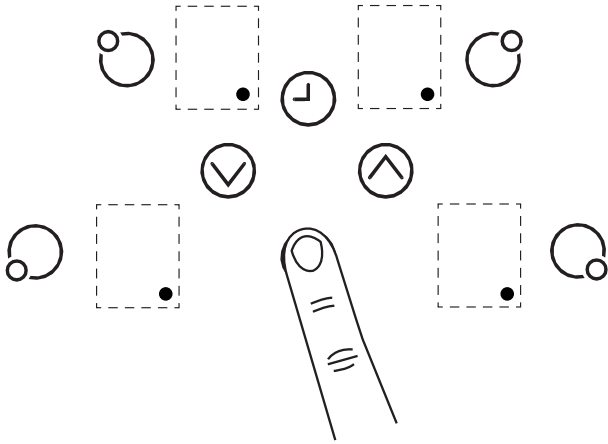

- 2** Touch the right hand cook zone key and the down key together

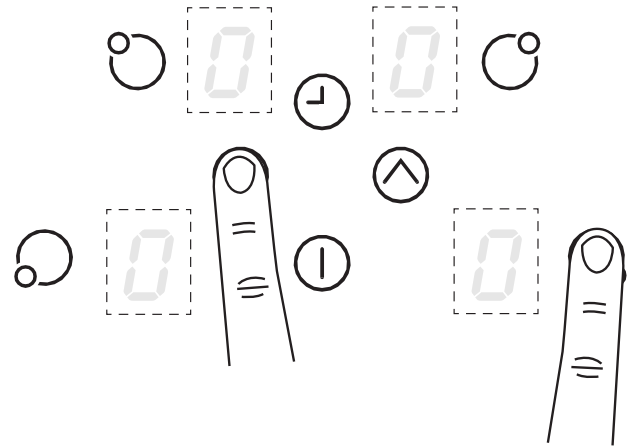

- 3** Touch the right hand cook zone key and L will appear on all displays

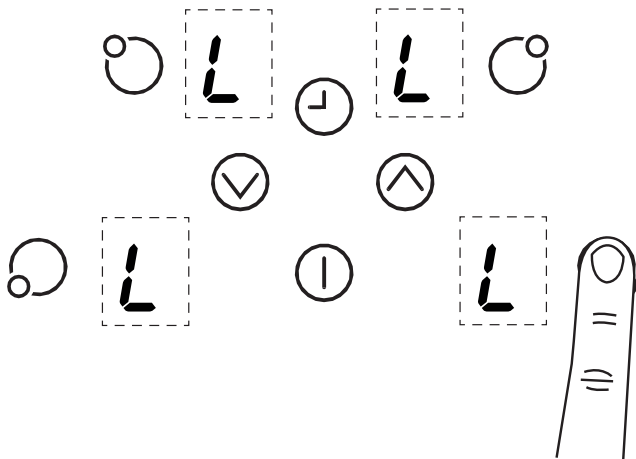

- 4** Press the on/off key to switch the hob off

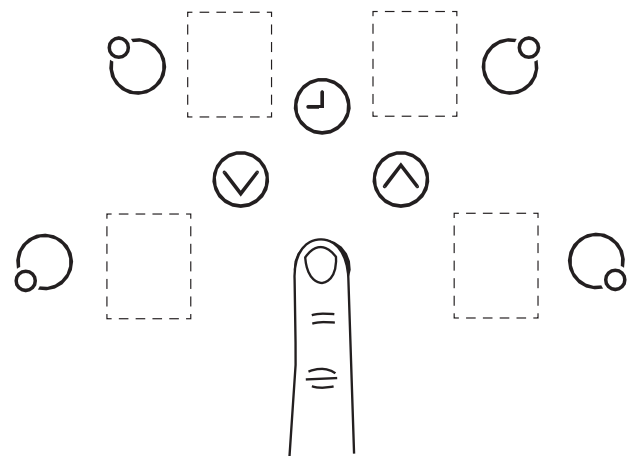

When you now switch on the hob "L" will appear in all the cook zone displays. The child lock feature will be activated until you switch this feature off.

De-activate child lock

- 1** Select the on/off key and L will appear on all displays

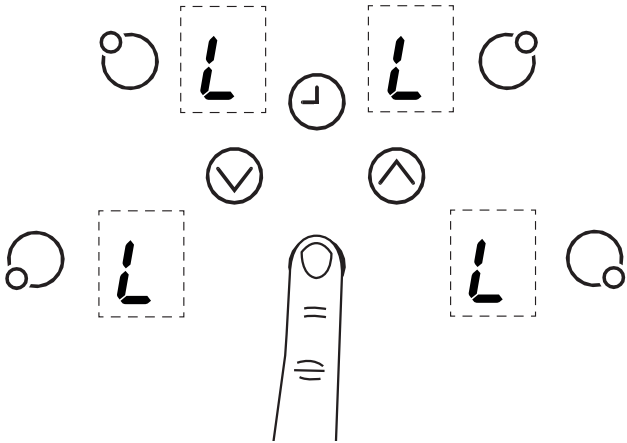

- 2** Touch the Right hand front key and the down key together

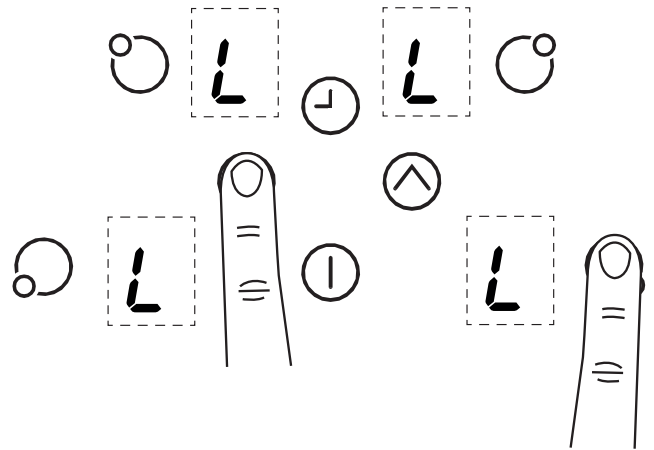

- 3** Press the minus key and the hob should switch off

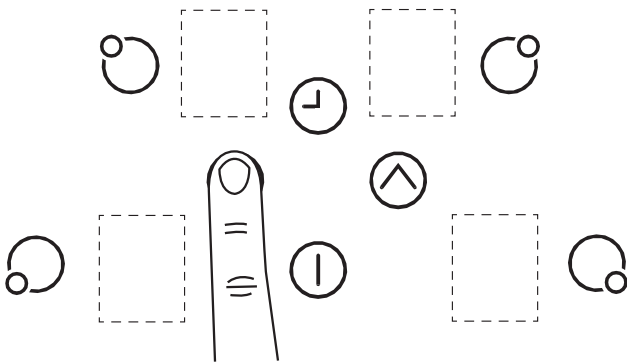

- 4** Switch on the hob and 0 will appear in all cook zone displays

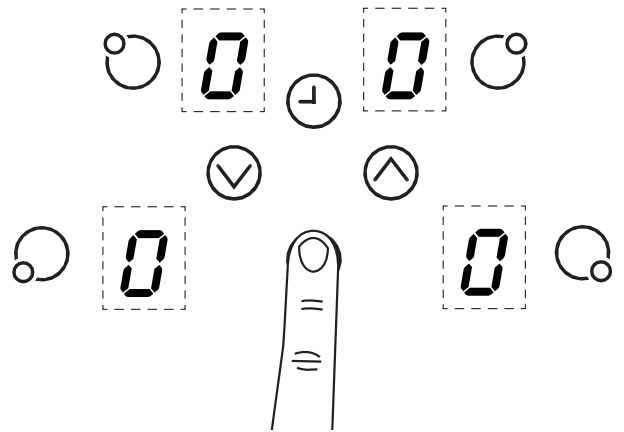

Note: When you now switch on the hob “0” will be displayed in all cook zone displays, the hob can now be used normally.

Setting the minute minder

- 1** Touch and hold the on/off key for 1 second

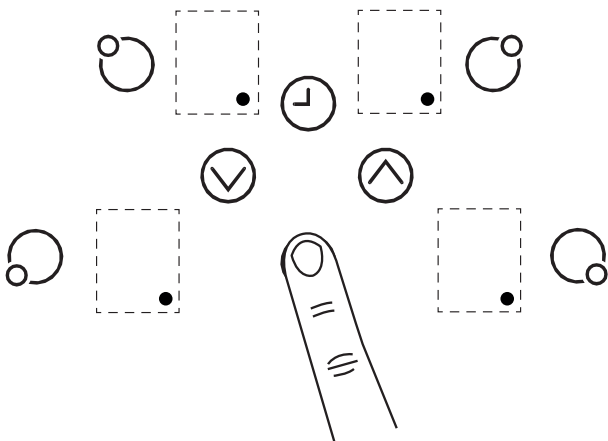

- 2** Touch the plus and minus keys together
The display will show 00

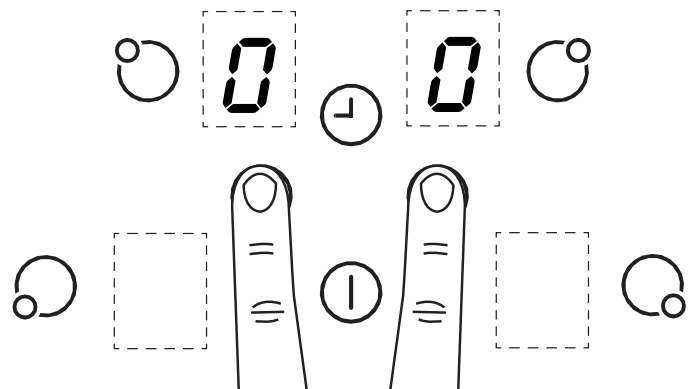

3 Pressing the down key first sets the timer to 30 minutes

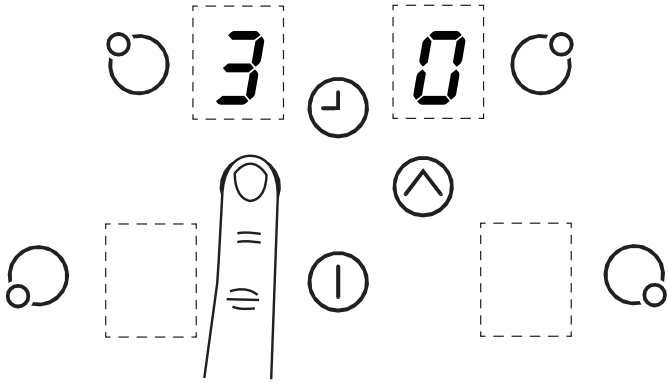

4 Adjust the time by using the up and down keys

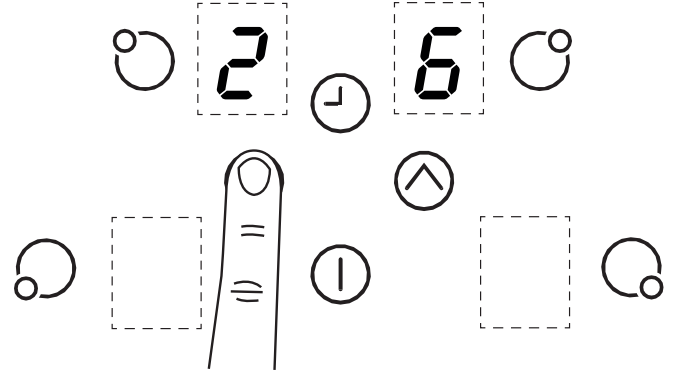

5 Once set, the minute minder will begin to count down

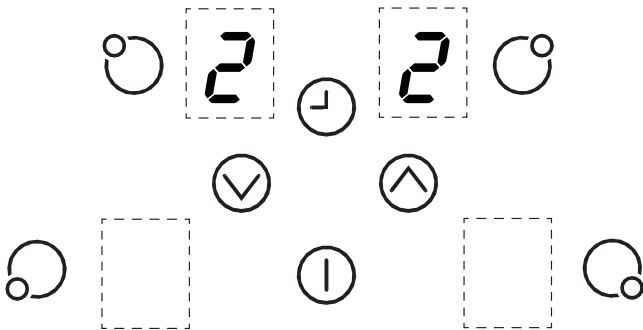

6 The timer display will flash and beep when the time is up. Touch any key to stop

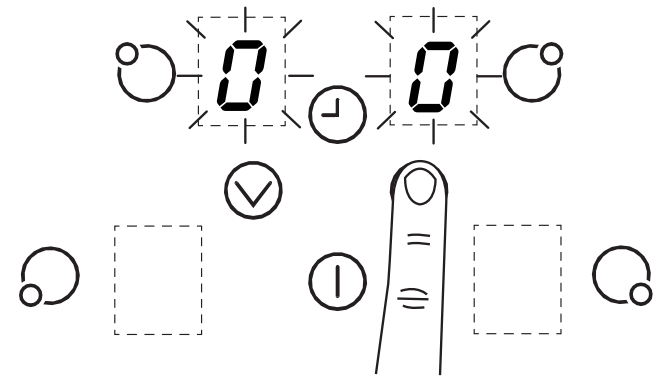

The maximum time that can be set is 99 minutes.

Please ensure that no cook zones have been selected.

When the set time has expired, it does not switch off any cook zones.

The dots will flash on the display if the hob is turned off before the minute minder ends.

To modify or cancel the minute minder

Please follow steps 1 to 5 if the hob is turned off or steps 2 to 5 if the hob is on.

Setting back to zero will cancel the minute minder.

Timer auto switch off

1 Select desired cook zone and ensure the power level is already set

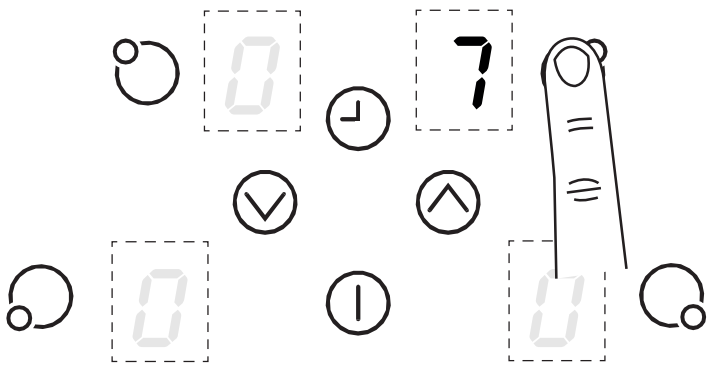

2 Touch and hold to down and up keys together, until 00 and a dot flashes in the timer display

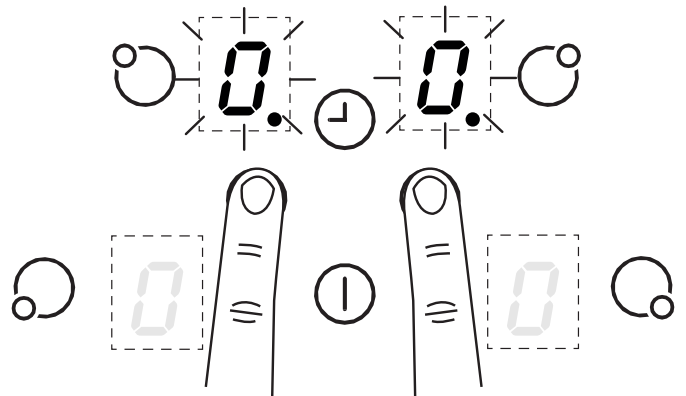

3 Use the up and down keys to set a time

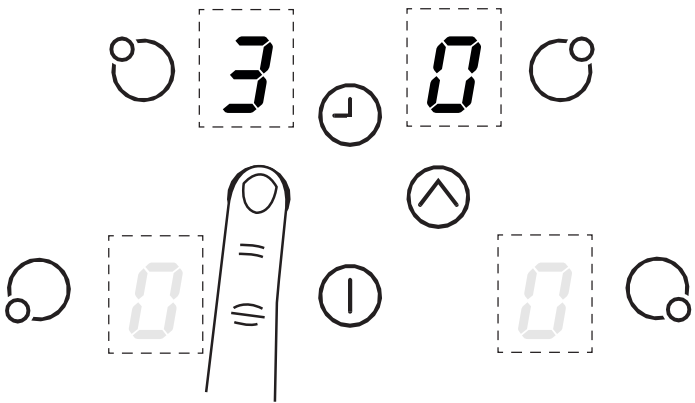

4 Once set, the operation of the timer is shown by a dot appearing in chosen cook zone display

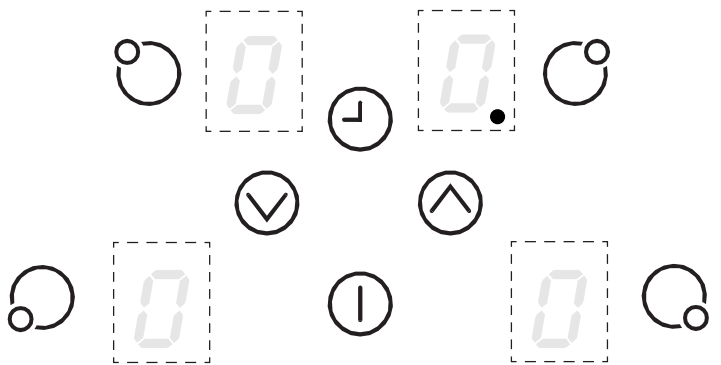

5 The timer display will flash and beep when the time is up. Touch any key to stop

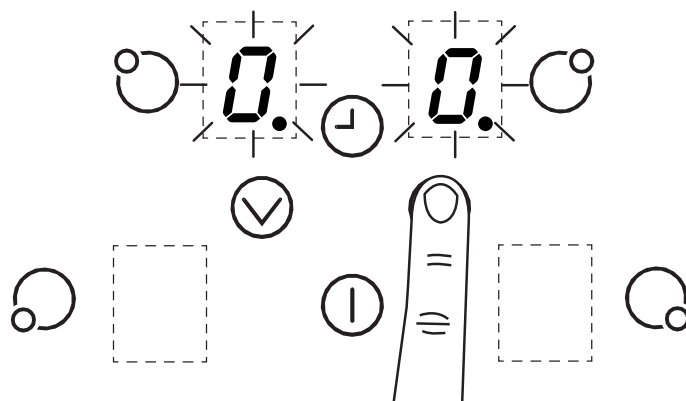

To modify or cancel the timer auto switch off

Please follow steps 1 to 5 if the hob is turned off or steps 2 to 5 if the hob is on.

Setting back to zero will cancel the minute minder.

To check the time for a cook zone

1 Select the timed cook zone

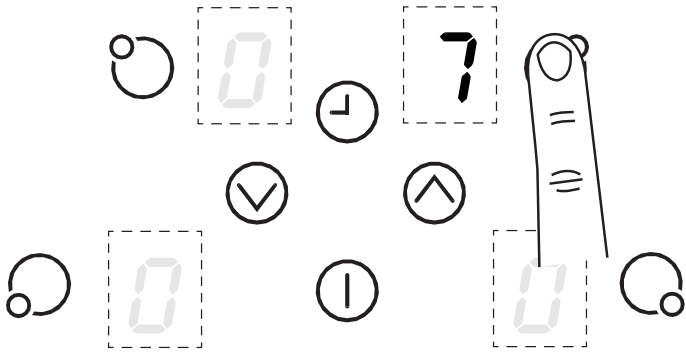

2 Press the up and down keys together to display the time remaining

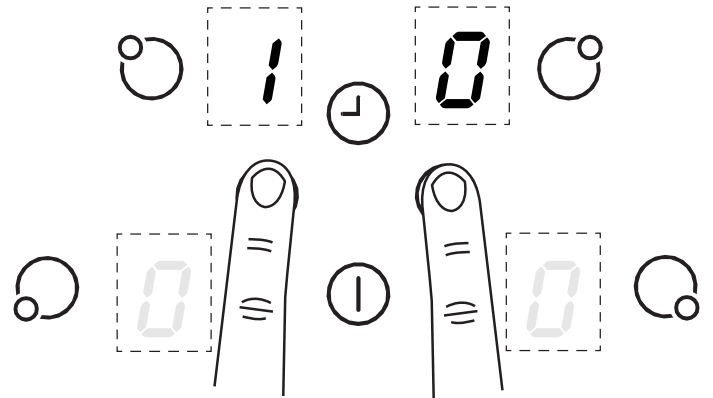

To check the time on multiple cook zones

If multiple timers have been set:

1 Ensure that a cook zone has not been selected

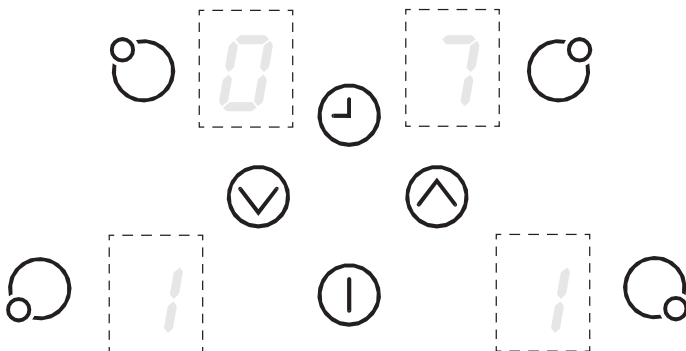

2 Select the timer by pressing the up and down keys together

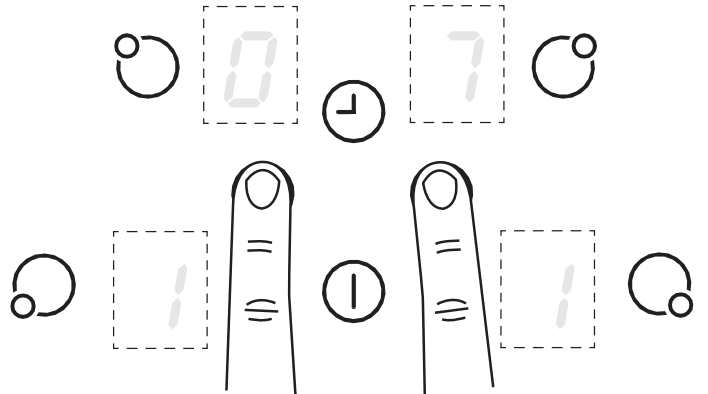

3 Press the up and down keys as many times as necessary to display set times for each cook zone

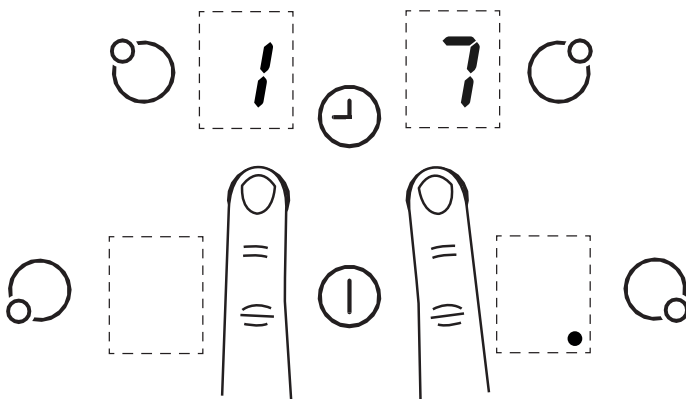

4 The active cook zone times are cycled clockwise. A dot will flash in the display for the chosen cook zone

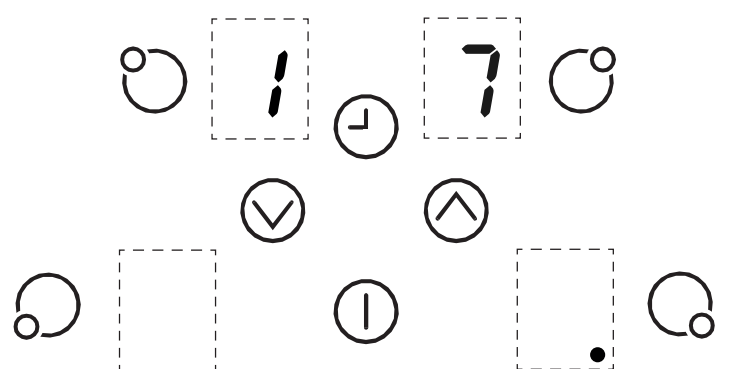







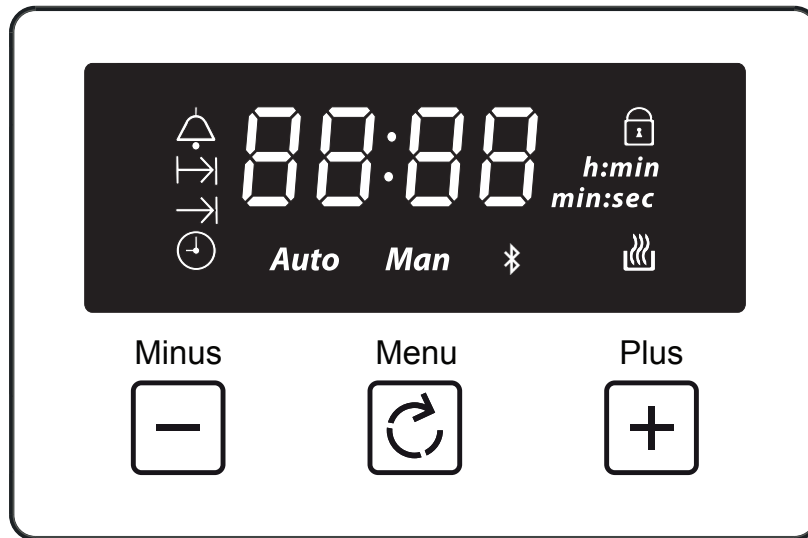

Note: If the minute minder has also been set it will be displayed first. In this case other timed cooking zones are shown by a dot in the cook zone display.

Please be aware that only the main oven is controlled by the programmer.

Clock / Programmer

Note: Your clock / programmer may not have all these functions



| | | | |
|---|-------------------------|----------------|-------------------------------|
|  | Minute minder | Man | Manual mode |
|  | Cooking time / Duration | L 1, L 2, L 3 | Volume level |
|  | End of cooking time | 23:59 | 7-segment display |
|  | Time of day | 99:00 | Max. adjustable minute minder |
|  | Keylock | 23:59 | Max. adjustable cooking time |
|  | Auto cooking | h:min | Display hours:minutes |
| Auto | Automatic mode | min:sec | Display minutes:seconds |
|  | Bluetooth Connectivity | | |

Using the touch controls

Menu - Scroll through to select a function

Plus - Increase time or volume

Minus - Decrease time or volume

When a function is selected and the time or volume is set, the chosen function will automatically start seven seconds after setting.

Manual Mode

If the programmer is not in semi-automatic or full-automatic mode you can use oven functions manually. The manual icon is also on the display.

Setting the time of day

By pressing menu, scroll through the functions until you reach 'time of day'.

- 1 Press the function button until the 'time of day' symbol appears

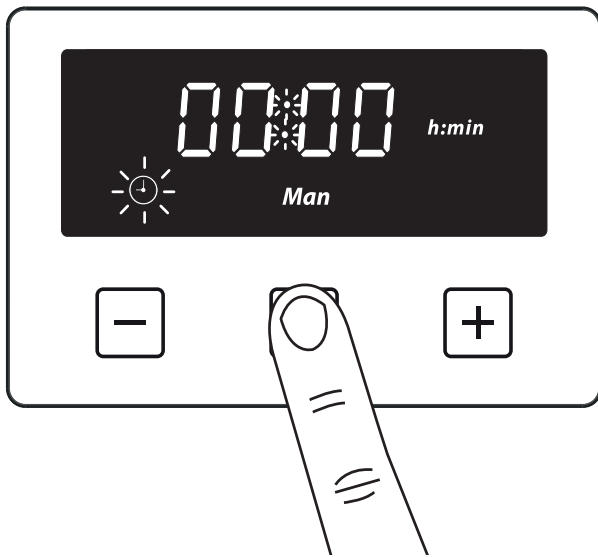

- 2 Press the plus or minus buttons to set a time

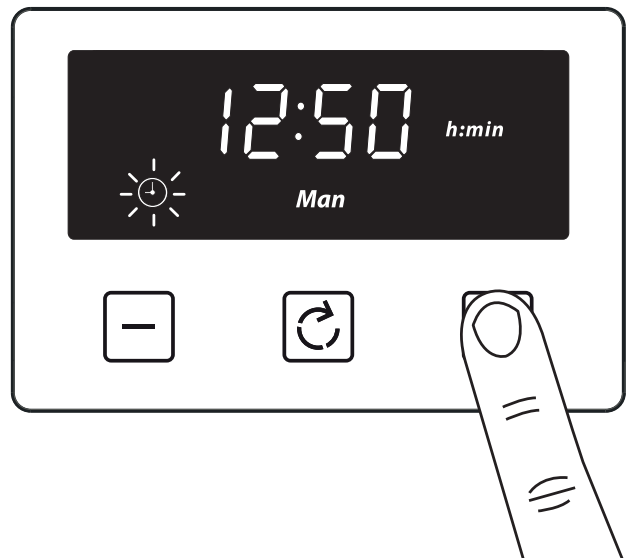

Setting the minute minder

The maximum cooking time that can be set is 99 minutes.

- 1 Press the function button until the 'minute minder' symbol appears

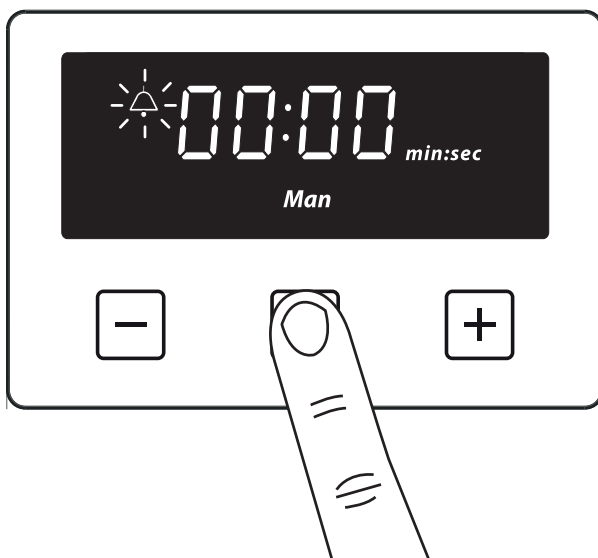

- 2 Press the plus or minus buttons to set a time

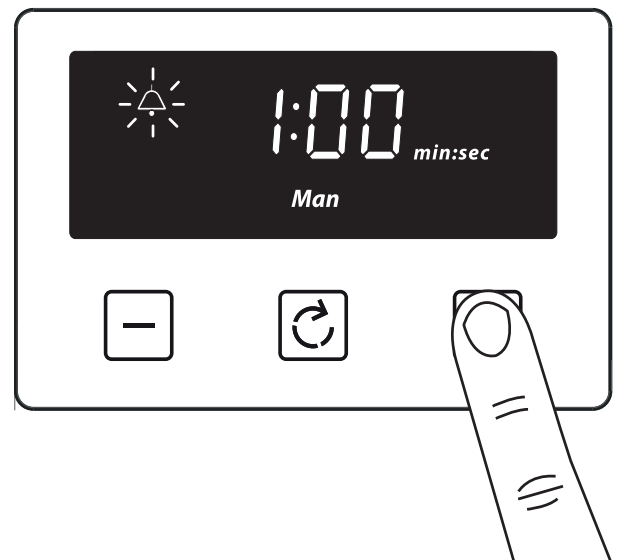

Once set, the minute minder will start to countdown in steps of seconds. The display will show the minute minder symbol and the remaining time. The countdown will continue in the background, if other functions are being set.

When the set time for the minute minder has completed, an alarm is heard and the minute minder symbol will flash on the display. Press any button to stop the alarm and the time of day is displayed.

To modify or cancel the minute minder

Return to the minute minder function and use either the plus or minus buttons to adjust the time. By setting the time to '0.00', this will cancel the countdown.

Setting the cooking time (the duration of time the oven will operate for) Semi Automatic cooking

The maximum cooking time that can be set is 23 hours and 59 minutes.

1 Press the function button until the 'cooking time' symbol appears

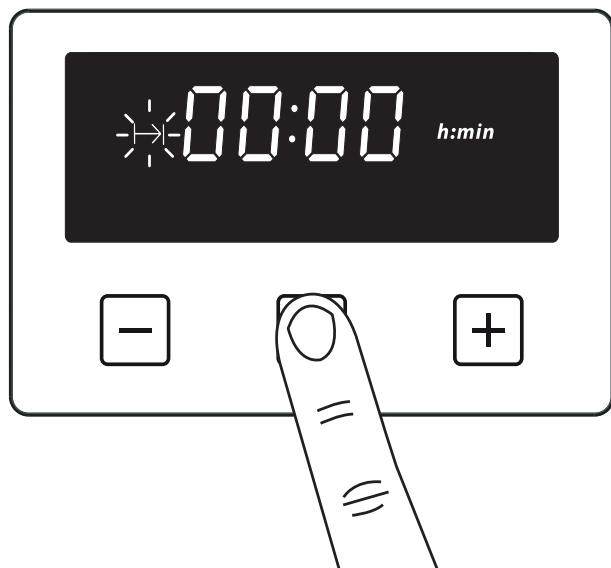

2 Press the plus or minus buttons to set a time



Once set, the automatic mode, auto cooking symbol and the time of day is displayed.

When cooking is completed, an alarm is heard and the manual mode symbol flashes on the display. Press the Menu button to stop the alarm and then the 'time of day' will then be displayed. Pressing the Menu button again will return to manual mode.

To modify or cancel the cooking time

Return to the 'cooking time' function and use either the plus or minus buttons to set the time. By setting the time to '0.00', this will cancel the countdown.

Setting the end of cooking time (to set a time for the oven to turn off) Fully Automatic

Enter cooking duration as described in 'Setting the cooking time' section.

The display shows the current 'time of day' plus the 'end of cooking time' symbol. The latest 'end of cooking time' is limited to the current 'time of day' plus the maximum time that can be set (23 hours and 59 minutes).

1 Press the function button until the 'end of cooking time' symbol appears



2 Press the plus or minus buttons to set a time

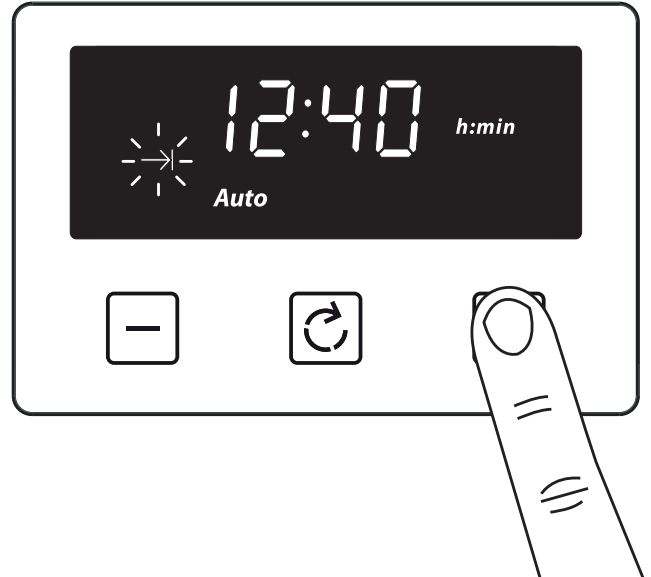

The auto cooking symbol disappears from the display once the time, the required cooking settings and temperature have been set. The appliance will not be switched on until the set cooking start time, that is the difference between the cooking end time and the cooking duration.

When cooking is completed, an alarm is heard and manual mode symbol flashes on the display. Press the menu button to stop the alarm. Pressing the Menu button again will return to manual mode.

To modify or cancel the end of cooking time

Return to the 'end of cooking time' function and use either the plus or minus buttons to set the time. The 'end of cooking time' can be deleted by counting back using the minus button until it equals the current time of day.

Setting the volume

Press the menu button until "LX" (X = 1, 2 or 3) flashes on the display. Use the plus or minus buttons to select a tone.

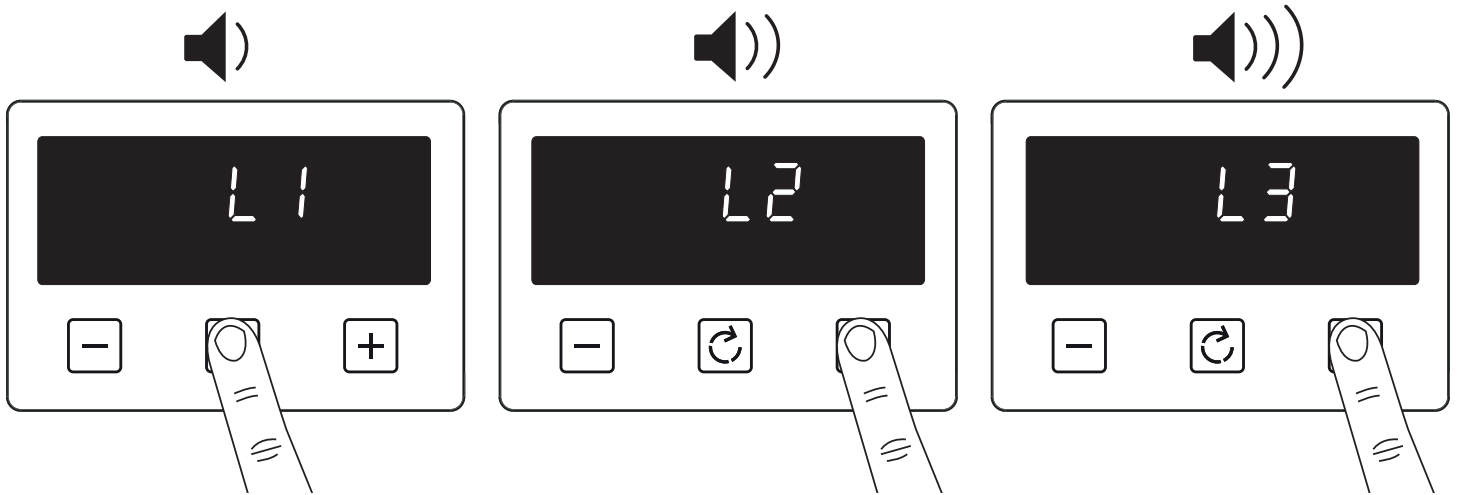

Note: Default tone is L3

Activating / deactivating Key lock

1 Press and hold the plus button for 3-5 seconds

2

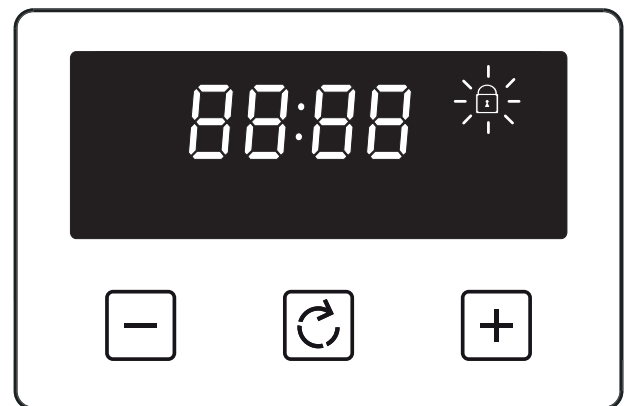
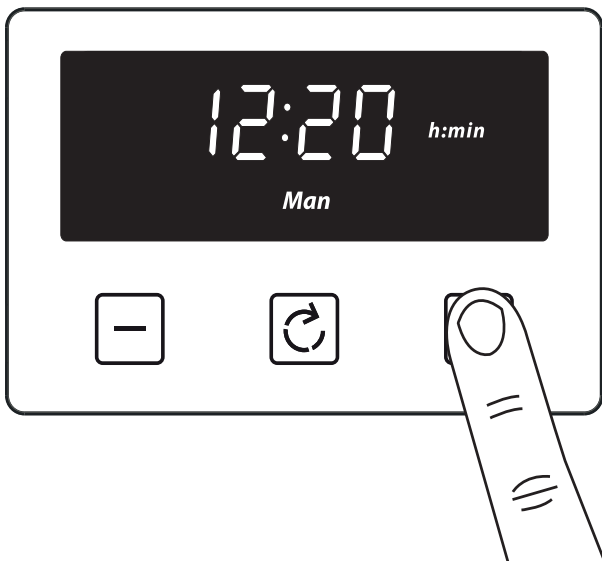

Once the Key lock is active, the buttons will be inactive. A two beep signal will be heard if the buttons are pressed.

To deactivate the Key lock

Press and hold the plus button for 3-5 seconds. The Key lock symbol will disappear and the appliance can continue to be used.

Note: In case of main power loss for a short time (about 1.5 minutes), timer maintains its status. Key lock status and buzzer tone are memorized independent of the power loss duration.

Bluetooth Connectivity

State of Connectivity Symbol

- When the connectivity symbol is not present, the appliance cannot be connected to.
- When the connectivity symbol is blinking, the appliance is ready to be paired with a smart device using the Zeus App.
- When the connectivity symbol is solid, the appliance is connected to a smart device and can be set using the Zeus app.

Activating / deactivating the bluetooth connectivity

1 Press and hold the menu button for 2 seconds until a beep is heard



2 The connectivity symbol will start flashing. The timer is now ready to be connected to a smart device



3 To switch off, press and hold the menu button for 2 seconds. The connectivity symbol will disappear



Clear Memory

- 1** Press the menu and plus button at the same time until a beep is heard.

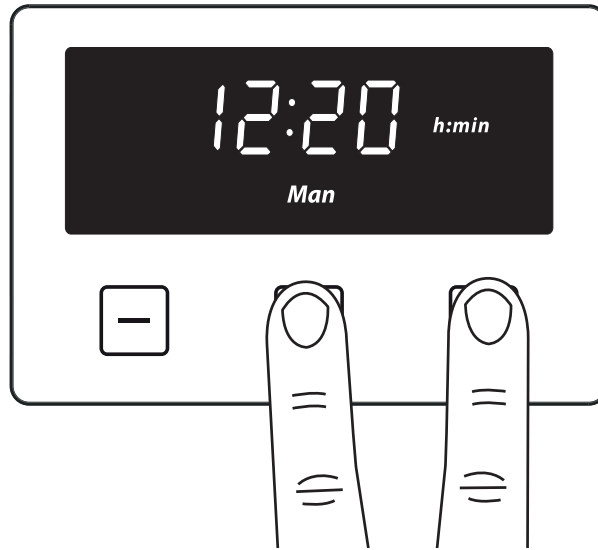

Once the beep is heard, any paired data will be cleared.

Delete pairing information in the Bluetooth Settings of your smartphone or tablet.

How to read the 6-digit pairing code

1. When the smart device connects to the appliance through the Zeus App, the App will ask for a unique pairing code that will be displayed on the timer.

Note: Every time a new smart device connects through the Zeus App to the appliance, a different pairing code is displayed.

2. When prompted to enter the 6-digit code, the code will appear on the timer. The 6-digit code will scroll across the timer display from the right to the left.

Note: Be aware that the display can only show four digits at a time.

Please refer to the website at the front of this guide for more information or download the Zeus App (Available on iPhone and Android)

Removing Shelf Runners

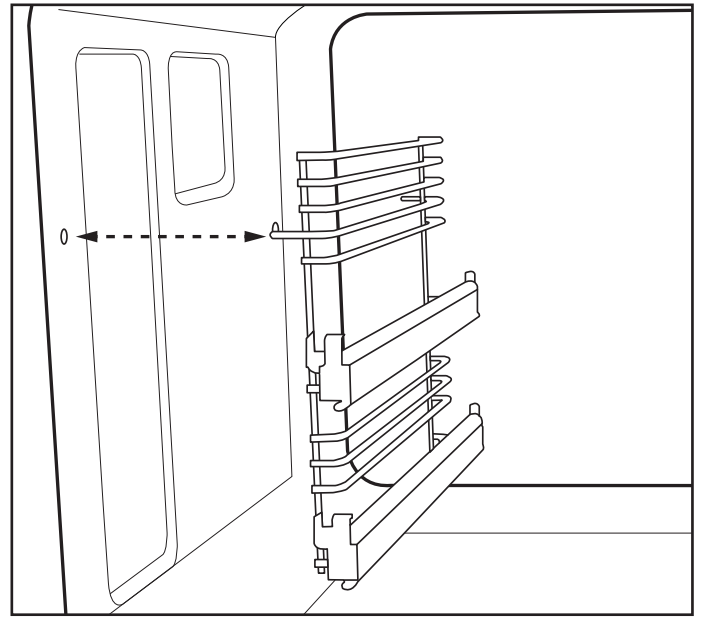
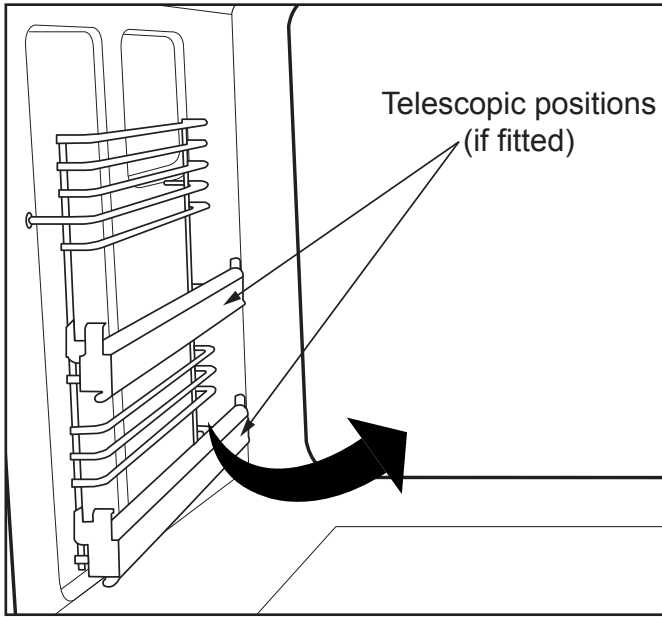

Standard shelves

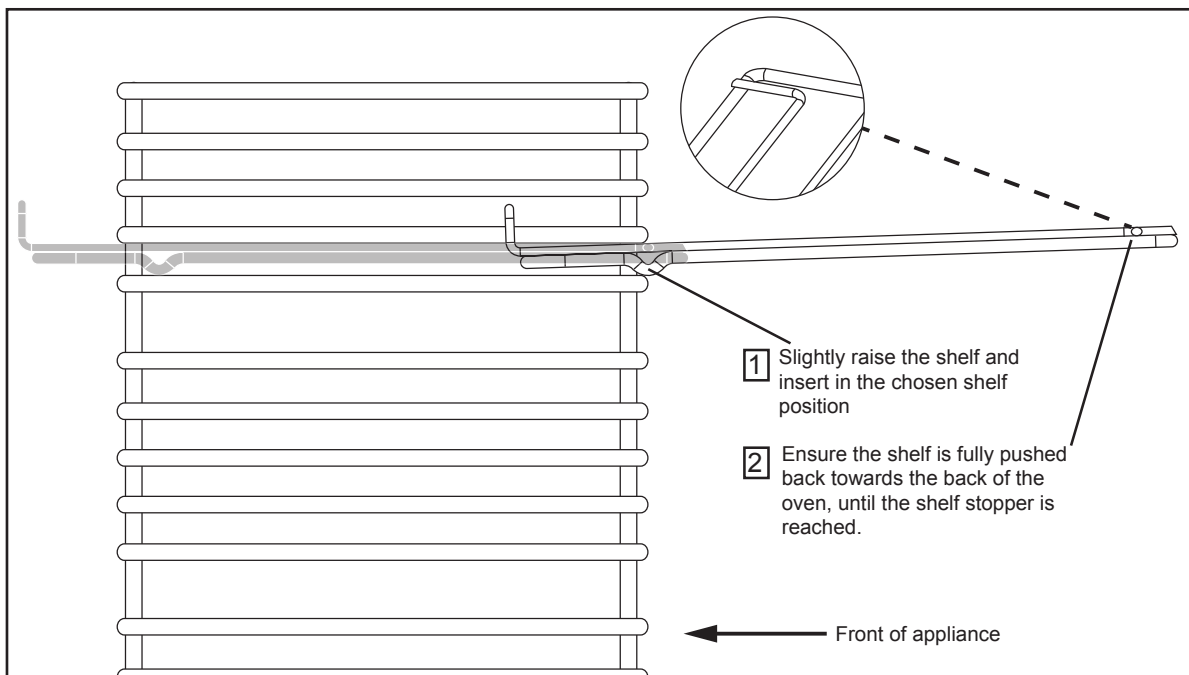

Removing Telescopic shelves (if fitted)

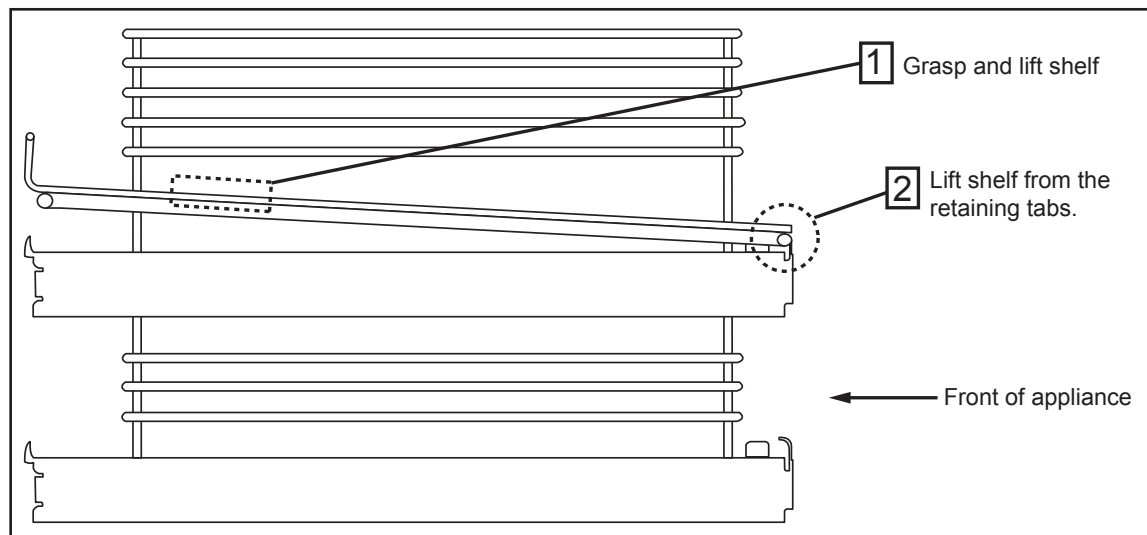

Before removing the shelves completely, please make sure that the shelf is unclipped from the retaining tabs.

Changing the light bulb

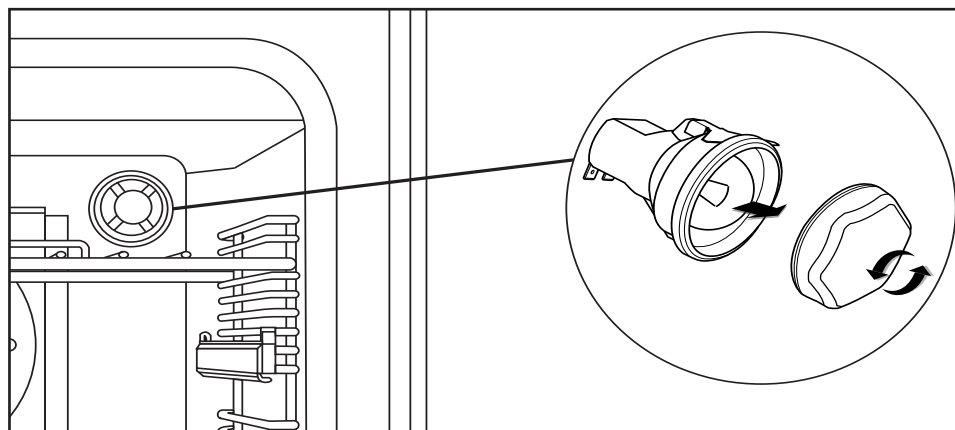

Not all appliances have the same number and type of bulbs. Before you replace your bulb, check to see what type you have. **Please remember that bulbs are not covered by your warranty.**

Additional features

Plate rack (if supplied)

1. Pull the shelf out of the cavity.
2. Tilt the plate warmer towards you and make sure that it hooks underneath the shelf bars at the front.
3. Drop the plate warmer carefully into position.

The plate warmer is now secure and you can place your plates into it.

Always make sure that you use oven gloves if you are putting the plate warmer into a hot, or recently used oven to prevent burns.

Always make sure that your plates are suitable for warming - some plates may shatter or crack when exposed to heat.

We recommend that you heat the oven to 70°C, or below, if you are warming plates.

CLEANING YOUR APPLIANCE

Do's

Note: Always switch off your appliance and allow it to cool down before you clean any part of it.

Note: Please take extra care when cleaning over the symbols on the control panel, as this can lead to them fading.

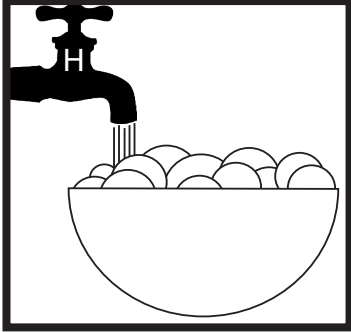

- Warm, soapy water

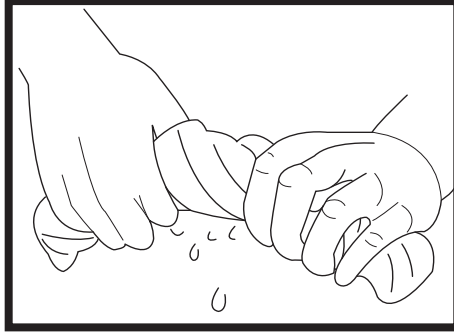

- Clean, wring out cloth

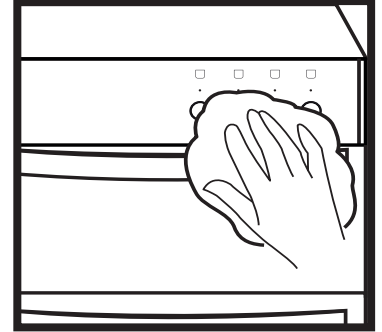

- Wipe with damp cloth
- Dry with a soft cloth

Tips: Some foods can mark or damage the metal or paint work e.g.; Vinegar, fruit juices and salt. Always clean food spillages as soon as possible.

Dont's

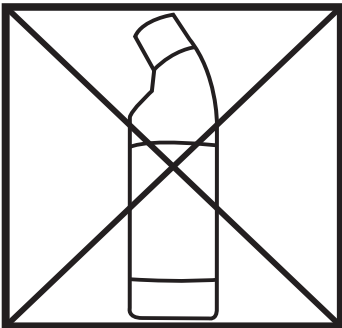

- Undiluted bleaches
- Chloride products

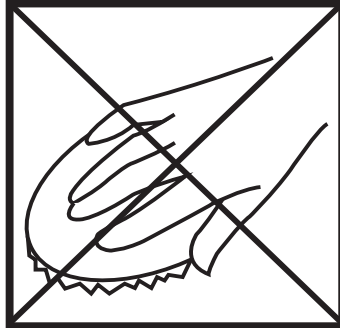

- Wire Wool
- Abrasive cleaners
- Nylon pads
- Steam cleaners

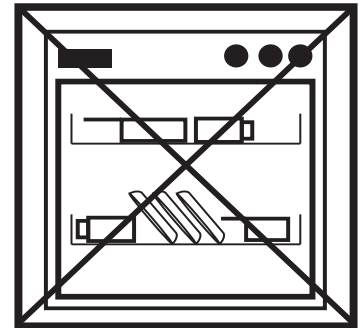

- Do not place in the dishwasher:
- Cast iron griddle
 - Pan supports

IT IS IMPORTANT TO CLEAN YOUR APPLIANCE REGULARLY AS A BUILD UP OF FAT CAN AFFECT IT'S PERFORMANCE OR DAMAGE IT AND MAY INVALIDATE YOUR GUARANTEE.

IN ADDITION TO THE ABOVE, DO NOT USE METAL SCRAPERS TO CLEAN THE OVEN DOOR GLASS.

We offer a great range of cleaning products and accessories for your appliance. To shop, please visit our website located at the front of this User Guide.

Please keep this handbook for future reference, or for anyone else who may use the appliance.

Please keep this handbook for future reference, or for anyone else
who may use the appliance.

TECHNICAL DATA

Electric Induction Mini Range

| Electrical supply / Load | | | |
|--------------------------|-------------------|-----------|---------------|
| Appliance Size (cm) | Electrical supply | Hotplate | Load (W) |
| 55 / 60 | 220 - 240V ~ 50Hz | Induction | 11430 - 12370 |

The data badge is located at the lower part of front frame, behind the door.

WARNING: This appliance must be earthed.

EU Declaration of Conformity

We Glen Dimplex Home Appliances
 Of Stoney Lane, Prescott, Merseyside, L35 2XW, UK

In accordance with the following Directive(s):
 2014/53/EU Radio Equipment Regulations

Hereby declare that: **ST RICH 600E and ST RICH 600Ei**

Are in conformity with the applicable requirements of the relevant Union harmonisation legislation:

| <u>Ref No.</u> | <u>Title</u> | <u>Edition/date</u> |
|----------------|--|---------------------|
| EN 301 489-1 | ElectroMagnetic Compatibility (EMC) standard for radio equipment and services; Part 1: Common technical requirements; Harmonised Standard covering the essential requirements of article 3.1(b) of Directive 2014/53/EU and the essential requirements of article 6 of Directive 2014/30/EU | V2.1.1 |
| EN 301 489-17 | ElectroMagnetic Compatibility (EMC) standard for radio equipment and services; Part 17: Specific conditions for Broadband Data Transmission Systems; Harmonised Standard covering the essential requirements of article 3.1(b) of Directive 2014/53/EU | V3.1.1 |
| EN 300 328 | Wideband transmission systems; Data transmission equipment operating in the 2,4 GHz ISM band and using wide band modulation techniques; Harmonised Standard covering the essential requirements of article 3.2 of Directive 2014/53/EU | V2.1.1 |
| EN 62479 | Assessment of the compliance of low power electronic and electrical equipment with the basic restrictions related to human exposure to electromagnetic fields (10 MHz to 300 GHz) | 2010 |

This declaration of conformity is issued under the sole responsibility of the manufacturer I hereby declare that the equipment named above has been designed to comply with the relevant sections of the above referenced specifications. These appliances comply with all applicable Essential Requirements of the Directives.

Signed: 
 Name: Paul Mulvenna
 Position: Product Approval Manager
 Location: Glen Dimplex Home Appliances, Prescott
 On: 18th September 2018 Issue 1



Document Reference No.
 Freestanding Electric Cookers - RED



The appliances listed on Page 1 are also in accordance with the following Directive(s):

- 2014/35/EU The Low Voltage Directive
- 2014/30/EU The Electromagnetic Compatibility Directive
- 2011/65/EU Restriction of the use of certain Hazardous Substances in electrical and electronic equipment

Are in conformity with the applicable requirements of the following documents

| <u>Ref No.</u> | <u>Title</u> | <u>Edition/date</u> |
|----------------|--|---------------------|
| EN 60335-1 | Household and similar electrical appliances. Safety. General requirements | 2012 +A11 |
| EN 60335-2-6 | Household and similar electrical appliances. Particular requirements. Particular requirements for stationary cooking ranges, hobs, ovens and similar appliances | 2015 |
| EN 62233 | Measurement methods for electromagnetic fields of household appliances and similar apparatus with regard to human exposure. | 2008 |
| EN 55014-1 | Electromagnetic compatibility. Requirements for household appliances, electric tools and similar apparatus. Emission | 2006 +A1 +A2 |
| EN 55014-2 | Electromagnetic compatibility. Requirements for household appliances, electric tools and similar apparatus. Immunity. Product family standard. | 2015 |
| EN 61000-3-2 | Electromagnetic compatibility (EMC). Limits. Limits for harmonic current emissions (equipment input current ≤ 16 A per phase). | 2014 |
| EN 61000-3-3 | Electromagnetic compatibility (EMC). Limits. Limitation of voltage changes, voltage fluctuations and flicker in public low-voltage supply systems, for equipment with rated current ≤ 16 A per phase and not subject to conditional connection | 2013 |
| EN 50581 | Technical documentation for the assessment of electrical and electronic products with respect to the restriction of hazardous substances | 2012 |

This declaration of conformity is issued under the sole responsibility of the manufacturer. I hereby declare that the equipment named above has been designed to comply with the relevant sections of the above referenced specifications. These appliances comply with all applicable Essential Requirements of the Directives.

Signed: 
 Name: Paul Mulvenna
 Position: Product Approval Manager
 Location: Glen Dimplex Home Appliances, Prescot
 On: 18th September 2018



Document Reference No.
 Freestanding Electric Cookers - RED

