

S7 - C900HY

Handbook

Accolade from

STOVES

Now Stoves thought for food

Contents

Before using your appliance	3
About The S7 - C900HY (Includes Technical Data)	6
Safety	7
What The Symbols Mean	8
Using The Hob (general information)	9 - 12
Induction (safety, types of pans, cooking tips)	13 - 18
Care & Cleaning	19
Troubleshooting	21
Installation	22
Service Record	26
Customer Care	Inside back cover

Before Using Your Hob

Thank you for purchasing a new Stoves Electric Hob. Its stylish and practical design will enhance your kitchen and make cooking a pleasure. Even if you have used a electric hob before, it is important that you read these instructions thoroughly before starting to cook, paying particular attention to the installation and safety instructions.

If you have any problems with any aspect of your Stoves hob, please check through these instructions thoroughly to make sure that you have not missed anything. If you still need help, then please contact us using the customer care centre number at the back of this book.

Before using this appliance please make sure that you have removed all packaging and wrapping. Some of the furniture inside this appliance may have additional wrapping.



Although every care has been taken to ensure this appliance has no burrs, or sharp edges, we recommend that you wear protective gloves when installing and moving this appliance. This will prevent any injury.

Our policy is one of constant development and improvement. Strict accuracy of illustrations and specifications cannot be guaranteed. Modification to design and material may be necessary subsequent to publication.



Always use a registered installer for this appliance. **WARNING! For your own safety, make sure that these instructions on installation, use and maintenance are followed.**



Environmental protection:

Glen Dimplex Home Appliance brands are committed to protecting the environment and operates an Environmental Management System which complies with BS EN ISO 14001.



All packaging with this appliance is recyclable and environmentally friendly.



Please recycle whenever possible - contact your local authority for your nearest recycling centre.



This appliance is for use in a domestic kitchen only, it is not designed, or intended, for commercial use.



Please keep these instructions in a safe place. Should you sell or pass on the appliance, please give the new owner this handbook.

About The S7 - C900HY

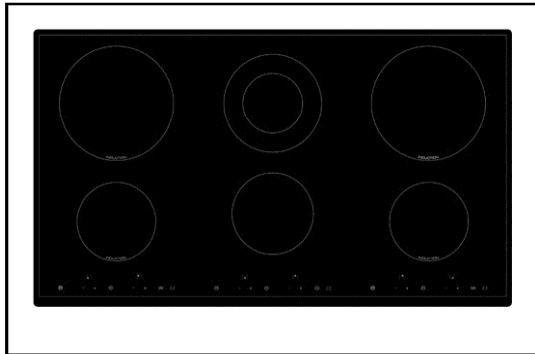

Hob Details		
Element Type	Rating (kW)	Additional information
Large	2.3* induction	Maximum load: 12.1kW Ratings based on : 220 - 240 V ~ 50Hz
Small	1.4* induction	
Medium dual zone	1.8 ceramic	
Small	1.1 ceramic	
Hob Dimensions		
Width	880mm	
Depth	510mm	
Height (ABOVE WORKTOP)	4mm	
Cut out required (WxD)	854mm x 488mm	
Hob Aesthetics & Features		
6 elements	Child lock	Keep warm
Timer	*Boost lge (3.2kW) *Boost sml (1.8kW)	Easy clean glass hob

Safety

Keep children away from the vicinity of the hob when you are cooking.

- Use pans with a flat base of minimum 128mm / 5 ins diameter, and maximum 230mm / 9 ins diameter, which are stable in use, and avoid using any old misshapen pans or any pan which is unstable when placed on a flat surface.
- Never leave fat or oil unattended on a lit hotplate.
- Do not stare at the halogen hob element - doing so may temporarily impair your vision.
- This appliance is not intended for use by persons (including children) with reduced physical, sensory or mental capabilities, or lack of experience and knowledge, unless they have been given supervision or instruction concerning use of the appliance by a person responsible for their safety.
- Children should be supervised to ensure that they do not play with the appliance
- Keep all flammable materials away from the hob.
- Do not place aluminium foil or plastic utensils on hot surfaces.
- Turn pan handles to a safe position, so they are out of reach of children, not overhanging the appliance and cannot be caught accidentally.
- Commercial simmering aids should not be used as they create excessive temperatures that can damage the surface and may cause a hazard.
- **Caution:** Do not use the hob if the glass is cracked, as electrical parts are directly beneath. To avoid the possibility of electric shock, turn off the electricity supply to the hob at the socket and arrange a Service call.

When you have finished cooking check that all controls are in the off position.

Safety & Induction

Detection of an object or a pan on the heating zone

A small object - such as a fork, a spoon or even a ring - placed on a hob cooking zone on its own is not detected as a pan.

The display flashes and no heating power is supplied.

The security system acts in the same way when it detects a pan which is not suitable for use on an induction hob.

If you are fitted with a pacemaker or an active implant

The functions of the hob comply with the applicable standards on electromagnetic interference

Your induction cooking hob thus complies fully with the statutory requirements (Directive 89/336/EEC). It is designed to not interfere with the functioning of other electrical equipment as long as these also comply with the same regulations.

Your induction hob generates magnetic fields in its immediate vicinity.

So that there is no interference between your cooking hob and a pacemaker, the pacemaker must be designed in compliance with the appropriate regulations.

In this respect we can only guarantee the compliance of our own product. You can ask the manufacturer or your doctor about the compliance or any incompatibilities of your pacemaker.

About The Induction Elements

About induction

Induction heating is a different type of heating system to the ones you are probably familiar with. With conventional heating elements, the element heats up and transfers this heat to the pan through radiation.

Induction elements, put simply, are powerful electro-magnets. When a magnet material is placed within the magnetic field (on the element), the element transfers (induces) the energy (heat) into that metal. The transferred energy causes the metal (cooking vessel) to become hot.

In this way, the heat for cooking food is produced directly inside the pan, the hob top hardly heats up at all, as it only receives heat from the pan placed on it. Compared with conventional cooking hobs, the induction hob is:

- **Quicker** - Full wattage of power is immediately available at the heating zone.
- **More efficient / Economical** - when a pan is lifted off, the zone stops heating immediately.
- **More precise & Responsive controls** - the hob reacts immediately to your instructions.
- **Safer** - the temperature of the glass top remains relatively low.

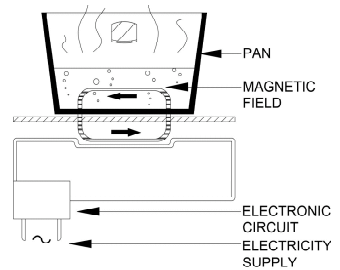

Choice Of Pans

The most suitable pans for induction cooking are listed below.

Choose a pan bearing the 'Class Induction' logo on its base or packaging to be sure that it is perfectly suitable for use on your hob under normal conditions of use. You can also find a range of pans suitable for induction cooking by looking in quality kitchen shops. Look for the wording and symbol "suitable for induction".

You probably already have some suitable pans:

- **Pans in enamelled steel, with or without non-stick coating**

For example; cooking pot, chip pan, frying pan, meat grill pan, etc.

- **Cast iron pans**

To avoid the risk of scratching the glass top of your hob, use pans with an enamelled base, or avoid sliding the pan across the glass surface.

- **Stainless steel pans suitable for induction**

Most stainless steel pans are suitable for induction cooking (saucepan, pot, frying pan, chip pan, etc).

Some stainless steel pans have copper bases which are usually not suitable.

- **Aluminium pans with a special base**

Choose pans with a thick base, as this ensures more even cooking (the heat is more evenly distributed).

The pan test

Because of its leading-edge technology, your induction hob is able to "recognise" most pans.

Place your pan on a heating zone on power setting **4**;

- If the *indicator stays fixed*, your pan is *compatible*.
- If the *indicator flashes*, the pan *cannot be used* for induction cooking.

The magnet test

A simple way to determine whether a pan is suitable for induction is to use a magnet on the bottom surface of the pan. If the magnet will stick to the surface, then the pan is suitable for induction.













Incompatible pans

Glass, ceramic or earthenware pans, aluminium pans (unless they have a special base), copper pans, some non-magnetic steel pans.



Note : A pan with a base not absolutely flat may still be suitable, as long as it is not too distorted.

What The Symbols Mean

Symbol	What does it do?
	<p>Element position Indicates which element you are using, or wish to use. The corresponding controls are close to this symbol.</p>
	<p>Increase / decrease These symbols adjust the heat setting for the element you are using. They can be touched at anytime during cooking while the hob is in normal use. 1 = low setting 9 = high setting</p>
	<p>Power On / Off Touch this control to switch the appliance on and off.</p>
	<p>Pause / resume Touch and hold this control if you wish to Pause the hob for a short time e.g. to answer the phone. The hob will cease working until you touch the control again - with any other icon, resuming at exactly the same heat setting.</p>
	<p>Minus For use with functions such as the minute minder or timer (if fitted).</p>
	<p>Plus For use with functions such as the minute minder or timer (if fitted).</p>
	<p>Boost A full power boost until the contents of the pan is at boiling point. The heat setting will then reduce to a pre-selected heat setting to continue cooking.</p>
	<p>Simmer A low heat for gentle cooking of delicate foods which require little heat e.g. melting chocolate or butter.</p>
	<p>Lock Locks the touch controls to prevent accidental adjustments or activation.</p>
	<p>Pan detector or Single / Dual Element selector The pan detector (when activated) detects whether or not a pan is made of ferrous material and the hob will only switch on if it is. The Single / Dual element selector, when touched, activates either the Single element or the Dual element - to suit your requirements.</p>

Control panel layout

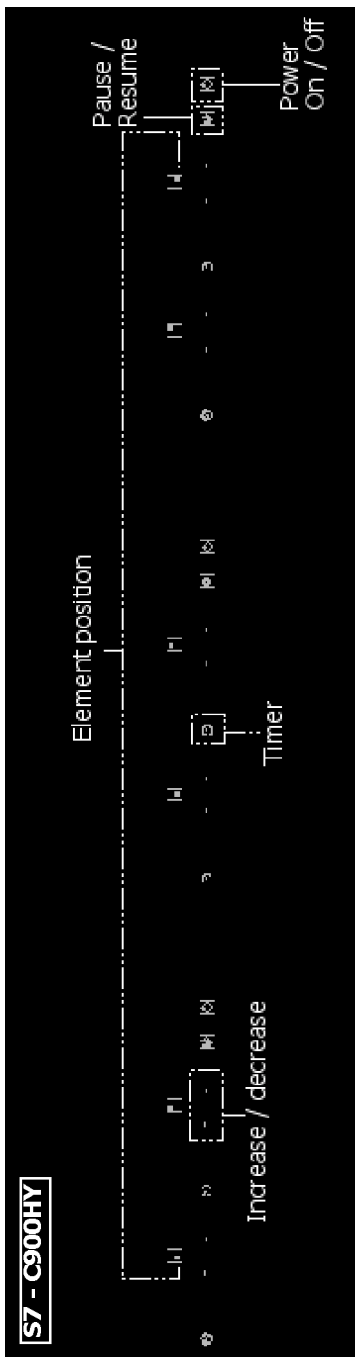

Using The Hob

To switch on/ off

- Touch the power on / off for the selected zone.
- The display will illuminate, and each heat setting area will show 0.
- Touch the + or - icon for the zone you wish to use.

For ceramic zones:

By pressing the + icon you will activate a default setting of 4 in that zone.

By pressing the - icon you will activate a default setting of 9 in the zone.



For Induction zones:

By pressing the + icon you will activate a default setting of 6 in that zone.

By pressing the - icon you will activate a default setting of 12 in the zone.

- The heat setting can be adjusted using the - or + icons whenever you need to during cooking.
- To switch off the individual elements either: touch and hold the - icon until 0 appears, or touch and hold both - and +.
- To switch off all of the elements and the entire hob, touch the power on / off.

Single or Dual zone selection (if fitted)

- To select either a single or dual zone, touch the  on the control panel.
- Touch  and a neon above the icon illuminates - dual element active.
- Touch  and **no** neon above the icon illuminates - single element active.

Using The Hob

The hot hob light / indicator

- When the hob has recently been used, an "H" will illuminate in the heat setting area to show that the hob may be hot to touch.
- It is advisable to take care around the hob when the "H" is illuminated.

Pause / resume - Induction zones only

- Touch and hold the pause/resume icon, if you need to briefly switch the hob off.
- Touch the icon again, an audio signal will sound, then touch any other icon, to resume cooking on the previous heat setting.

Note: If you decide to switch the power off while the hob is paused, you must remember to 'resume' when you come to use the hob the next time.

Choose and assign.

Choose either the simmer or boost function and assign it to element by touching either the + or - on the control panel which corresponds to the desired element.

Simmer

- This function uses a very low, constant heat ideal for delicate sauces and melting chocolate and butter.
- In the heat setting area near to the element you have selected "Lo" will illuminate to indicate Simmer is in use.
- To switch off, touch - or increase the heat if required using the +.

Using The Hob - Other Features

Boost - Ceramic zones

- This function is rapid, full power heat until the contents of the pan is boiling.
- It will then reduce to a pre-selected heat setting.
- The heat setting you require for after boost, is set by pressing - (heat setting 9 appears), press +, and an "A" appears on the display. Press - to select the heat setting you require.

Boost - Induction zones

- To activate the boost function touch the - (setting 12 will appear on the display) then touch the + and a "P" will appear in the display.
- Unlike the ceramic zones, the Induction boost **does not** reduce down to a pre-selected heat setting.

The Timer

- Set the heat zone to the desired heat setting.
- Touch the  which is located adjacent to the heat zone controls.
- Use the - + controls, near the heat zone, to set the duration time you require.
- An audio signal will sound once the various times have counted down and the zone will switch **off** at the end of the set cooking time.

Safety

Regularly check that there is nothing (cloth, paper, etc) which might block the air inlet underneath your hob (see section "Installation Instructions").



Always remember to switch off the appliance after you have used it. When using the timer - make sure the hob is switched off, after the zone has switched off.



Note: The indicator light will remain lit once the duration has been confirmed. Once a further zone is programmed and confirmed, that will remain lit and the indicator light for the zone programmed first will begin to flash. **This is not an error**, continue with cooking, or programming.



The hob is equipped with residual heat indicators. The display shows 'H' if the temperature of that heating zone exceeds 60°C.

This prevents the risk of burning.



Please note: This handbook applies to more than one type of hob.

Although there may be slight differences between types of hob i.e. graphics, the principles of operation remain the same.

Cooking On Induction Hobs

- Do not leave an empty pan on a heating zone.
- Pans should be placed in the centre of the heating zone.
- Never heat up a sealed tin of food, as it may explode.
- When you use a pan with a non-stick coating (eg; Teflon) with little or no fat, heat the pan first for a moment on setting **6** or **7**.
- We recommend that you do not put metal cooking utensils, cutlery, knives or other metal objects on the hob, as they could become hot if they are near a cooking area which is in use.
- It is perfectly possible to use a pan with a smaller diameter than that of the ring marked on the vitro-ceramic glass (note that we recommend a minimum 5" pan base diameter); there will be no loss of energy as is the case with conventional cookers (electricity and gas).
- Nothing should ever be left lying on the hob.
- Lift pans onto and off the hob, rather than sliding them across the surface, to avoid marks and scratches.
- As soon as the water boils, turn the cooking zones down to a lower setting; this will help prevent pans boiling over.
- As pans are on a smooth surface, they will move easily if knocked accidentally; turning pan handles so they are not overhanging the edge of the hob, will help prevent this happening and keep them out of the reach of children.
- Be careful when cooking foods in salted water, or foods containing large amounts of sugar or syrup, if they are spilt onto hot areas of the hob they may damage the glass.

Wipe any spillage as soon as possible.

Use pans which are large enough to avoid overflows onto the vitro-ceramic glass hob surface.



Do not use the hotplate surface for storage, as a chopping board or work surface. This may damage the glass or cause it to shatter without warning due to small chips in the glass.



Always switch off the appliance after use. Do not use the pan detector (if fitted) as a method of switching off the appliance.

Cooking Tips

- Green vegetables (spinach, broccoli, sorrel, etc) or vegetables rich in sulphur compounds (cabbage, onions, etc) should be cooked without a lid in plenty of boiling water; they will cook more quickly, and will keep their green colour (some vegetables only), vitamin and minerals content.
- Pasta, rice, cereals, etc absorb water during cooking and increase in volume; cook them in plenty of boiling salted water in order to dilute the starch they contain.
- Make sure you use a sufficiently large pan to avoid boiling over; the temperature setting may need to be reduced to maintain a simmer.
- Mushrooms should be poached in a small quantity of boiling water, with salt, butter and lemon juice.
- When liquids boil, reduce the control setting to maintain a simmer.
- Vegetables will cook quicker if chopped in smaller pieces.

Aluminium foil

When cooking, never use kitchen foil and never put items wrapped in kitchen foil straight onto the hob.

The aluminium kitchen foil may melt and do irreparable damage to your appliance.

Care & Cleaning

Some cooking operations generate a considerable amount of grease. This, combined with spillage, can become a hazard if allowed to accumulate on the hob through lack of cleaning. In extreme cases this may amount to misuse of the appliance and could invalidate your guarantee.

Do not use caustic pastes, abrasive cleaning powders, coarse wire wool or any hard implements, as they will damage the surfaces.

Do not use soap filled pads, metal wire, bleaches, bath stain removers, or chemical oven cleaners; all these product types will damage the ceramic glass.

All parts of the hob can be safely cleaned with a cloth wrung out in hot soapy water.

The following recommendations will help to keep the ceramic glass surface bright and clean:

- Use a dampened paper towel or clean damp cloth to apply a small dab of cleaner conditioner to clean each heating area.
- Use another paper towel or a clean dry soft cloth to wipe dry, and then polish the whole glass surface.
- To remove any stubborn marks or heavy soiling, a non scratching, mild cream cleaner may be used. Alternatively, a "ceramic hob scraper" may be used.

Important: If you use a wet paper towel or clean damp cloth to remove spillage from a warm heating area of the hob, be careful to avoid steam burns.



Always allow the hob to cool before cleaning.

Always: switch off the electricity supply before cleaning this appliance.

Caution: Any cleaning agent used incorrectly may damage the hob.



Do not use steam cleaners on any part of this appliance.

Care & Cleaning

Looking after your pans

Stainless steel pans

Stainless steel pans should be cleaned with a soft cloth and soapy water.

Appearance of white marks:

Cause: salt added to cold water.

Solution: add salt when the water boils.

Appearance of specks:

Cause: hard water.

Solution: boil diluted vinegar in the pan, then rinse and dry.

Burned food stuck to the bottom of the pan:

Cause: temperature too high.

Solution: leave the pan to soak, or boil soapy water in it (1 part washing-up liquid to 10 parts of water).

Cast iron pans

Cast iron pans should only be cleaned with a sponge or nylon brush or a non-abrasive washing-up product.

Wipe with a little vinegar to regain the pan's shine.

This also works for colour-enamelled cast iron. For "matt black" items, use vinegar instead of bleach, then oil carefully and wipe with kitchen roll.

Care & Cleaning

Care and maintenance

Before using the hob for the first time, apply a thin coating of cleaner conditioner to the ceramic glass, and polish the surface with a clean cloth.

The conditioner gives a protective covering to the ceramic glass which not only makes the hob easier to clean, but also ensures that you will gain maximum life out of this product. Occasional use will help prevent the build up of mineral deposits which can cause discolouration of the hob surface.

Discolouration of the hob

Do not use a dishcloth or dish sponge to wipe the hob - this can leave a film of detergent on the surface which will discolour the hob next time a heating area is used. Clean cloths kept for the cleaning of the hob can be used.

Do not use too much cleaner conditioner - only a thin coating is required, any excess may burn on and discolour the hob when it is next in use.

If persistent stains or marks remain on the ceramic glass surface, it can be cleaned using a mild cream cleaner or a ceramic hob scraper. This will also remove any accumulated salts or minerals before they have an opportunity to discolour the ceramic glass.

Wipe clean with a damp paper towel or clean damp cloth and re-apply cleaner conditioner.

Troubleshooting

The hob produces a smell the first few times it is used

- Heat a pan full of water on each zone for half an hour.

Pans make a noise during cooking!!

- This is caused by vibration due to the passage of energy from the hob to the pan.
- On a high setting this is quite normal for certain types of saucepan. It will not damage the hob.

The hob makes a slight clicking sound

- This is caused by the distribution of power between two heating zones on the same side of the hob.

The top of the hob is always warm (even when not in use)

- The electronic part of the hob, like any other electronic equipment (TV, transformer, etc), becomes warm.

The fan keeps working for a few minutes after the hob has been turned off

- To cool down the electronics.

Once a cooking zone has been turned on, the indicators on the panel keep flashing !!

- The pan you are using is not suitable for induction cooking or is less than 12cm (5") in diameter.

The hob won't work. The indicators don't come on

- The electricity supply is not reaching the appliance (faulty supply or connection);
Check the fuses and the cut-out switch.
- The electronic circuit is not working properly;
Call Stoves Customer Support, or your supplier.

When it is turned on, the appliance cuts out

- The hob connection is faulty.
- Check the connection and check that the connection complies with the appropriate standards.

When it is turned on, only one side of the hob works

- The hob connection is faulty.
- Check the connection and check that the connection complies with the appropriate standards.

Installation Instructions

General information

Installation should only be carried out by a qualified installer or engineer.

Please keep to the following points most carefully;

- The hob should not be fitted above a washing machine, a fridge or a freezer.
- Wall surfaces above the work surface and in the immediate vicinity of the cooking hob must be heat resistant.
- Laminated surfaces and the adhesive used for fixing them must be heat resistant in order to avoid any damage.
- The space for air circulation, located underneath and at the back of the hob improves its reliability by ensuring that it will cool down, however it has been fitted in.
- For installations in the Republic of Ireland, refer to National Regulations applicable to this product.



We recommend that you install this appliance in a work top which is a minimum 38mm deep. The hob can be fitted into a work top less than 38mm deep, but the 9mm gap between hob base and appliance must be maintained.

Choosing your installation

1. Over a unit with a door or drawer.
2. Above an oven.

In all cases your induction hob needs to be well ventilated.

Make sure that the air inlet through the ventilator grid underneath the hob are never blocked.

The hob must not be fitted over a washing machine, a fridge or a freezer.

Installing the hob over a unit with a drawer or door

Air outlet is underneath work surface.

If necessary, remove the front crosspiece of the unit.

Suitable protection to prevent obstruction of the air inlet to the fans must be provided.

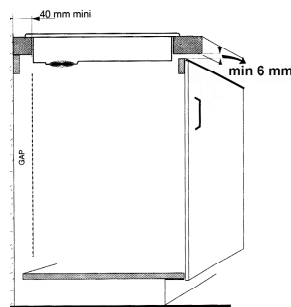

Installation Instructions

Installing the hob above an oven

In the event of repeated operation of the thermal protection devices, you can install an insulation kit between the oven and the hob (available from Stoves Customer Support or your local supplier).

With this configuration, the oven can be fitted in the unit in the lower position only.

Installing the hob above a Stoves 600mm single cavity oven

A minimum 9mm gap must be maintained between the oven top and the base of the hotplate.

Installing the hob above a Stoves 720mm twin cavity oven

A minimum 9mm gap must be maintained between the oven top and the base of the hotplate.

The appliance MUST be fitted on the runner kit provided. It is not suitable for shelf type installation if the plinth line is to be maintained.

Ovens other than Stoves

Refer to the manufacturer's instructions for clearances above the oven.

We recommend a 9mm gap between hob and appliance, should the work surface be less than 38mm deep.

Installing the hob above a pyrolytic oven

If installing the hob above a pyrolytic oven, additional provision for air circulation / ventilation may be required.

Due to the excessive temperatures attained during pyrolysis, using the hob at the same time may cause the thermal safety device within the hob to operate.

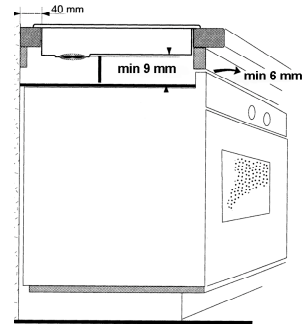

Installation Instructions

Fitting into worktop

- Cut a hole in the work surface to the required size. See table for relevant dimensions.

A clearance of at least 40mm should be maintained between the cutout and any rear or side wall.

- The cooking hob should be fitted into a worktop which is least 40mm thick. The worktop must be of heat-resistant material or covered with heat-resistant material.

- Protecting the cut-out;

The types of chipboard used for work surfaces swell relatively quickly in contact with humidity.

Apply a special varnish or adhesive to the cut edge to protect it from steam or condensation which may form under the work surface under the hob.

Cutout required	
S7 - C900HY	
WIDTH	854mm
DEPTH	488mm

Minimum clearance above the hob

Important: So that cooking utensils can be used easily, there should be no unit or vertical surface within 300mm of the cooking hob.

Installation Instructions

Connect to the electricity supply

Warning: This appliance must be earthed.

The hob must be installed by a competent electrician, using a suitable double pole control unit, with 3mm minimum contact separation at all poles.

We recommend that the appliance is connected by a qualified electrician who will comply with the I.E.E. and local regulations.

- Connection should be made with a suitable cable.
- First strip the wires, then push the cable through the cable clamp in the terminal block cover.
- Connect the cable to the terminal block and then tighten the cable clamp screw (see diagram).
- Close the terminal box, ensuring that the cover is engaged on the locking tabs.

i Important: Ensure that you route all mains electrical cables well clear of any adjacent heat source, such as an oven or grill.

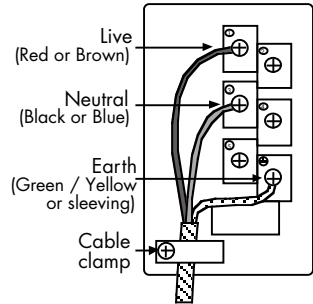

Live ⊕, Neutral ⊕⊖, Earth ⊕⊖

Secure hob to worktop

After connecting to the electrical supply, place the hob in the cutout and secure in place using the four brackets and screws provided.

The brackets should be orientated to suit the worktop thickness as shown, then inserted into the four slots (two on the front edge and two on the rear) and screwed into the underside of the worktop using the woodscrews provided.

The screws should be tightened just sufficiently to secure the hob to the worktop, but not overtightened as this may damage the glass top.

If the base of the hob is accessible after installation, than a partition must be fitted 20mm below the base to prevent access.

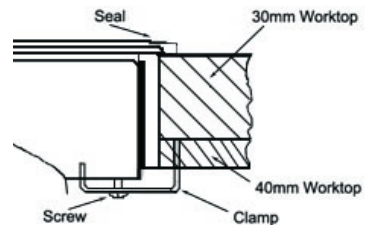

Service Record

Date of purchase	Installer stamp / Printed name	Date of installation
Place of purchase:		

Date	Part(s) replaced	Engineers Stamp/ Printed Name

Contact Us

Should you need to contact us, please call our Customer Care Centre on:

0871 22 22 502.

Calls will be answered in strict rotation, as soon as possible.

Model Number									
Serial Number									

Please record your model and serial number in the spaces above.
Having these numbers to hand will help us to help you quickly and more efficiently
should you need to call us for any reason.

Stoney Lane, Prescott, Merseyside L35 2XW
Tel: Customer Care 0871 222 2502
Trade Support 0871 222 2625
Customer Support Line 0871 222 2635
Fax: 0871 222 2645

Stoves is a member of Glen Dimplex Home Appliances



Now that's thought for food

www.stoves.co.uk