

600SIDODLa

Freestanding Gas Double Oven & Grill with Automatic Programmer

For Natural Gas Models & LP Gas Models

User & Installation Instructions

If you smell gas:

- Do not try to light any appliance.
- Do not touch any electrical switch.
- Call the Gas Emergency Helpline at TRANSCO on:

0800 111999

The Gas Consumer Council (GCC) is an independent organisation which protects the interests of gas users. If you need advice, you will find the telephone number in your local telephone directory under Gas.

The appliance must be installed (and serviced) by a Corgi registered approved installer or a person competent to ensure that the installation is in accordance with "The Gas Safety (Installation and Use) Regulations 1994", and the "The Gas Safety (Installation and Use) (Amendment) Regulations 1996". Failure to comply with these Regulations is a criminal offence.



CONTENTS

User's Section	2 - 24
Introduction	2
Be Safe - Not Sorry	5
Using the Hob	6
Using the Grill	8
Using the Ovens	10
Ignition	10
Oven furniture	12
Slow cooking	12
Top oven baking guide	13
Main oven baking guide	14
Traditional fruit cakes	15
Roast turkey	15
Roasting guide	16
Automatic cooking	17
Programmer / Clock	19
Cleaning	23
Installation Instructions	25 - 29
Technical Data	30
Stoves Customer Care	32

Please keep this handbook for future reference, or for anyone else who may use the appliance.

INTRODUCTION

Thank you for choosing a British built appliance by Stoves

We hope that the following information will help you to familiarise yourself with the features of the appliance, and to use it successfully and safely.

Our policy is one of constant development & improvement. Strict accuracy of illustrations and specifications is not guaranteed. Modification to design and materials may be necessary subsequent to publication.

This appliance must be installed in accordance with the regulations in force, and only in a well ventilated space. Read the instructions before installing or using this appliance.

Your new appliance is designed to be installed flush to base units.

Your 1st Year Guarantee

To fulfil the conditions of your guarantee, this appliance must be correctly installed and operated, in accordance with these instructions, and only be used for normal domestic purposes.

Please note that the guarantee, and Service availability, only apply to the UK and Republic of Ireland.

Stability bracket

If the cooker is to be fitted with a flexible inlet connection, a stability bracket should also be fitted to engage in the back of the cooker. Make sure this is re-engaged whenever you move the cooker for cleaning.

Gas & Electrical connection

Please refer to installation instructions for the Gas & Electrical Safety Regulations and the Ventilation Requirements.

In your own interest, and that of safety, it is the law that all gas appliances be installed by competent persons, who will ensure that the installation is in accordance with "The Gas Safety (Installation & Use) Regulations 1994", and the "The Gas Safety (Installation and Use) (Amendment) Regulations 1996". Failure to comply with these Regulations is a criminal offence.

Corgi registered installers undertake to work to satisfactory standards.

Disconnection of gas and electric appliances should always be carried out by competent persons.

Warning: This appliance must be earthed.

Before using the appliance for the first time, remove any protective polythene film and wash the oven shelves and furniture in hot soapy water, to remove their protective coating of oil. Even so, when you first turn on the oven or grill you may notice a smell and some smoke.

INTRODUCTION

Glass door panels

To meet the relevant Standards of Domestic cooking appliances, all the glass panels on this appliance are toughened to meet the fragmentation requirements of BS3193. This ensures that, in the unlikely event that a panel breaks, it does so into small fragments to minimise the risk of injury.

Please take care when handling, using or cleaning all glass panels as any damage to the surfaces or edges may result in the glass breaking without warning or apparent cause at a later date. Should any glass panel be damaged, we strongly recommend that it is replaced immediately.

The cooling fan

When the appliance is switched on, you may hear the cooling fan come on. This keeps the fascia and control knobs cool during grilling / cooking and will continue to operate for up to 15 minutes after the appliance has been switched off.

During oven use the fan may cycle on and off. Should any fault occur with the cooling fan, the appliance will require servicing. Contact Customer Support.

Ventilation

The use of a gas cooking appliance results in the production of heat and moisture in the room in which it is installed. Ensure that the kitchen is well ventilated: keep natural ventilation holes open or install a mechanical ventilation device (mechanical extractor hood). Prolonged intensive use of the appliance may call for additional ventilation, for example, opening of a window, or more effective ventilation, for example increasing the level of mechanical ventilation where present.

If the ignition fails:

- Check there is a spark when the ignition button is depressed. If there is no spark, check that the electricity supply is switched on at the socket.
- Check that the gas supply is switched on.
- Try another appliance in the socket, if that works, replace the 3 amp fuse in the cooker plug.

INTRODUCTION

Moving the cooker

Do not attempt to move the cooker by pulling on the doors or handles. Open the door and grasp the frame of the cooker, taking care that the door does not shut on your fingers.

Take care to avoid damage to soft or uneven floor coverings when moving the appliance. Some cushioned vinyl floor coverings may not be designed to withstand sliding appliances without marking or damage.

To replace a light bulb

Caution: Switch off the electricity supply to the cooker at the socket, to avoid the risk of electric shock.

Wait until the oven is cool, then remove the oven shelves.

Grasp the lens cover on the light fitting and pull it away from the side of the oven. Unscrew the bulb.

Please note that the oven light bulb is not covered by the guarantee. Replacement bulbs can be ordered from your local supplier, or bought from a hardware store.

Environmental Protection

Stoves Limited is committed to protecting the environment and operates an Environmental Management System which complies with BS EN ISO 14001:1996.

Disposal of packaging

- All our packaging materials are recyclable and environmentally friendly.
- Please help us to protect our environment by disposing of all packaging in an environmentally friendly manner.
- Please contact your local authority for the nearest recycling centre.

Caution: Packaging materials can pose a risk of suffocation - keep away from children.

BE SAFE - NOT SORRY

When you are cooking, keep children away from the vicinity of the appliance.

This product is designed as a domestic cooking appliance for the preparation and cooking of domestic food products, and should not be used for any other purpose.

- Remove all packaging, protective films and oils from the appliance before using for the first time.
- Make sure you read and understand the instructions before using the appliance.
- Keep electrical leads short so they do not drape over the appliance or the edge of the worktop.
- Keep all flammable materials (such as curtains, furnishings & clothing) away from the appliance.
- Parts of the appliance may be hot during or immediately after use. Allow sufficient time for the appliance to cool after switching off.
- Never use the appliance for heating a room.
- Do not drape tea towels over the flue vents or door, as this creates a fire hazard.
- When opening the appliance door, take care to avoid skin contact with any steam which may escape from the cooking.

- Do not use aluminium foil to cover the grill pan, or put items wrapped in foil under the grill as this creates a fire hazard.
- Do not use the oven with the door inner glass panel removed.
- Use oven gloves when removing hot food / dishes from the oven or grill. The oven / grill and utensils will be very hot when in use.
- Do not use foil on oven shelves or allow it to block the oven flue, as this creates a fire hazard, and prevents heat circulation.
- Switch off the electricity supply before replacing the oven light bulb, to avoid the risk of electric shock.
- When cooking heavy items - eg; turkeys - do not pull the oven shelf out with the item still on the shelf.
Drop-down top oven door: Do not place items on the door when open.
- When you have finished cooking check that all controls are in the "off" position.

All installation, servicing and maintenance work should be carried out by a competent person who will comply with current Regulations, Standards and Requirements.

As with all gas appliances, it is recommended that your appliance is serviced regularly.

USING THE HOB

Ignition

Push in and turn the selected control knob anticlockwise to the 'full on' position and press the ignition switch, or hold a lighted match or taper to the burner, until the burner lights. Turn the control knob to the required setting.

Adjust the burner flame so that it does not extend over the pan base.

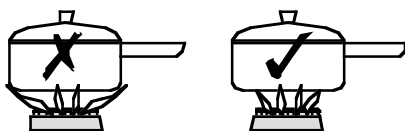

To turn off, push in the control knob and turn clockwise until the dot on the control knob is below the dot on the fascia panel.

To simmer

The simmer position is marked by the *small flame* symbol.

Once lit turn the selected control knob anticlockwise past the *large flame* symbol (FULL ON) to the *small flame* symbol.

You may hear a slight popping noise when the hob burners are operating and this is quite normal, but if anything about the cooker appears unusual, such as change in flame appearance, or the operation of controls - seek expert advice.

Pans

For optimum safety and performance, we recommend the use of flat bottomed pans with a base diameter of minimum 100mm (4") and maximum 250mm (10").

Do not use double pans, rim based pans, old misshapen pans or any pan which is unstable when placed on a flat surface.

Position pans over the centre of the burners, resting on the pan supports. If positioned off centre, smaller pans may be unstable.

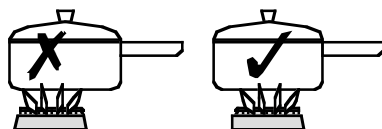

When cooking with fat or oil, never leave unattended.

Turn pan handles to a safe position, so they are out of reach of children, not overhanging the appliance, and cannot be caught accidentally.

Commercial simmering aids should not be used as they create excessive temperatures that can damage the surface and may cause a hazard.

Pan supports

Always make sure the pan supports are replaced correctly, and located in the hob spillage well.

USING THE HOB

To save gas

- Use the size of pan most suited to the size of the burner - ie; larger pans on the larger burners, smaller pans on the smaller burners.
- Adjust the flames so that they do not lick up the sides of the pan.
- Put lids on saucepans and only heat the amount of liquid you need.
- When liquids boil, reduce the control setting to maintain a simmer.
- Consider the use of a pressure cooker for the cooking of a complete meal.
- Potatoes and vegetables will cook quicker if chopped into smaller pieces.

The fold down lid

Caution: Glass lids may shatter when heated. Turn off all the burners before shutting the lid.

When opening and closing the lid, use the cooler outer sides of the lid trim.

The lid must be opened fully, so there is no danger of it closing while the hob is being used.

The appliance is fitted with a switch-back system, which will automatically turn off the hotplate controls if they are inadvertently left on as the lid is closed.

The lid is not intended to be used as a work surface, as it becomes hot when any part of the cooker is in use, and the surface may be scratched if items with rough or sharp surfaces are placed on it.

USING THE GRILL

Caution: Accessible parts may be hot when the grill is used - young children should be kept away.

Important: The top oven / grill door must be fully open when the grill is used.

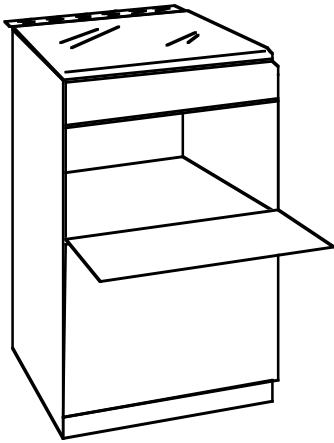

Ignition

Open the top oven / grill door. Push in and turn the top oven / grill control knob clockwise to the 'FULL ON' position and press the ignition switch until the burner lights.

In the event of the grill burner flames being accidentally extinguished, turn off the burner control and do not attempt to re-ignite the oven burner for at least one minute.

To switch off, push in the control knob and turn anticlockwise to return it to the off position.

Preheating

For best cooked results, we recommend that you preheat the grill for about 3 minutes.

Shelf positions

On a higher shelf position, the grill gives coverage over the area directly beneath the grill burner.

Use a higher shelf position for thinner foods and faster grilling. These shelf positions are suitable for toasting bread.

Use the lower shelf positions for grilling thick portions of food, or for slower grilling. The lower shelf positions are suitable for grilling all types of meat and fish.

Using aluminium foil

Using aluminium foil to cover the grill pan, or putting items wrapped in foil under the grill creates a fire hazard.

USING THE GRILL

Detachable grill pan handle

Place the handle over the edge of the grill pan. The handle should be removed from the pan during grilling, to prevent overheating.

The handle is designed for removing / inserting the grill pan under the grill when grilling.

If cleaning the grill pan when it is hot, use oven gloves to move it. *Do not* use the handle to pour hot fats from the grill pan.

Important: Never cover the grill pan or trivet with cooking foil or allow fat to build up in the grill pan, as this creates a fire hazard.

Grill pan trivet

Food for grilling should be placed within the area defined by the kinks in the trivet wires.

The grill pan trivet - inside the grill pan - can be inverted to give a high or low position, or it may be removed altogether to suit the type of food.

The base of the compartment can also be used - for example; when cooking whole fish, or when browning dishes such as cauliflower cheese.

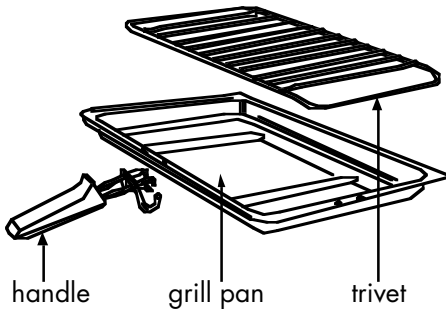

USING THE OVENS

When you are cooking keep children away from the vicinity of the oven.

Notes:

As part of the cooking process, hot air is expelled through a vent at the top of the oven(s). When opening the oven door, care should be taken to avoid any possible contact with potentially hot air, since this may cause discomfort to people with sensitive skin. We recommend that you hold the underneath of the oven door handle.

If it is found, over a period of time, that the oven becomes hotter when used at a particular temperature, then the thermostat may need to be replaced.

Using the main oven

Ignition

Push in and turn the control knob anticlockwise to the 'FULL ON' position - Gas Mark 9 - the oven burner will light automatically. Turn the control knob to the required setting.

It can take up to 60 seconds for the oven burner to come on to the full rate.

In the event of the burner flames being accidentally extinguished, turn off the burner control and do not attempt to re-ignite the oven for at least one minute.

To switch off, push in the control knob and turn clockwise to return it to the "off" position.

Using the top oven

Ignition

Push in and turn the top oven control knob anticlockwise to the 'FULL ON' position - Gas Mark 9 - and press the ignition switch until the burner lights. Turn the control knob to the required setting.

It can take up to 60 seconds for the oven burner to come on to the full rate.

In the event of the top oven burner flames being accidentally extinguished, turn off the burner control and do not attempt to re-ignite the oven burner for at least one minute.

To switch off, push in the control knob and turn clockwise to return it to the off position.

Using the top oven

The top oven can be used in the same way as the main oven, to cook the full range of dishes, but it is a SECONDARY oven and there are some differences.

Foods cooked in the top oven should be in relation to the oven size. Larger dishes, or food which may rise during cooking, should be cooked in the main oven.

Large items, wide tins and tall items such as rich fruit cakes should be cooked in the main oven to obtain optimum results.

USING THE OVENS

Preheating

Always preheat the top oven for 15 minutes. However, if the main oven is being used at the same time, then preheating may not be necessary. The cooking time may need to be shortened slightly, or the cooking temperature adjusted, to allow for heat transfer from the main oven to the top oven if both ovens are used together.

Preheat the main oven for 15 minutes. If you are not preheating the ovens, the cooking times in the baking guides may need to be extended, as they are based on a preheated oven.

The ovens **must** be preheated when reheating frozen or chilled foods, and we recommend preheating for yeast mixtures, batters, soufflés and whisked sponges.

Put the oven shelves in the position required before preheating the oven.

Oven light

Press the light button on the fascia panel.

Zones of heat

The temperature at the **centre** of the oven corresponds with the selected gas mark and is slightly higher towards the top of the oven and slightly lower towards the oven base.

These zones of heat can be useful as different dishes requiring different temperatures can be cooked at the same time, when more than one shelf is used.

The temperature at the oven base is suitable for cooking baked vegetables, baked fruit, milk pudding etc, and for warming bread rolls, soup, coffee, or ovenproof plates and dishes.

If you find that over a period of time, the oven becomes hotter when used at a particular gas mark, the thermostat may need to be replaced.

USING THE OVENS

Oven furniture

Baking tray and roasting tins

For best cooked results and even browning, the maximum size baking trays and roasting tins that should be used are as follows;

Baking tray 350mm x 330mm

Roasting tin 370mm x 320mm

Position baking trays and roasting tins on the middle of the shelves, and leave one clear shelf position between shelves, to allow for circulation of heat.

Oven shelves

The oven shelf must be positioned with the upstand at the rear of the oven and facing upwards.

Extra shelves may be ordered from your local supplier.

You will see that there are differences between the oven shelves for the top oven and the main oven.

The top oven shelf helps to ensure even baking in the top oven. It has a rear deflector fitted to it, and is **not** intended for use in the main oven.

Baking guide hints

The gas mark settings and times given in the top baking guides are based on dishes made with block margarine. If tub margarine is used, it may be necessary to reduce the gas mark setting.

If a different gas mark setting to that shown in our guide is given in a recipe, the recipe instruction should be followed.

The cooking times given in the baking guides are based on a preheated oven. If you do not preheat the oven, cooking times should be extended.

Slow cooking

Make sure that frozen foods are thoroughly THAWED before cooking.

Do not slow cook joints of meat or poultry weighing more than 2½kg / 4½lb.

Always use the top half of the oven for slow cooking.

For roasting joints of meat or poultry, and for pot roasts preheat the oven to gas mark 6 and cook for 30 minutes, then adjust the oven control to the "S" slow setting for the remainder of the cooking time.

Slow cooking times will be about three times as long as conventional cooking times.

USING THE OVENS

Top oven baking guide

Dish	Recommended gas mark	Suggested shelf position	Approximate cooking time (preheated oven)
Scones Meringues	7 "S" slow setting	top - middle bottom	10 - 15 mins 2 - 3 hours
Cakes Small cakes Whisked sponge Swiss roll Victoria sandwich (2 x 180mm / 7" per shelf) Genoise sponge (2 x 180mm / 7" per shelf)	5 5 6 4 5	middle middle middle middle (side by side) middle	15 - 25 mins 20 - 30 mins 10 - 12 mins 20 - 35 mins 25 - 30 mins
Pastry Rough Puff Flaky / Puff Shortcrust Flan	7 6 6 6	middle middle middle middle	cooking time depends on recipe & type of filling
Biscuits Shortbread fingers Nut brownies Brandy snaps Flapjacks Ginger nuts	5 5 4 4 5	middle - top middle middle - top middle - top middle - top	20 - 30 mins 25 - 35 mins 10 - 15 mins 25 - 40 mins 15 - 20 mins

USING THE OVENS

Main oven baking guide

Dish	Recommended gas mark	Suggested shelf position	Approximate cooking time (preheated oven)
Scones Meringues	7 "S" slow set	middle - top bottom	8 - 15 mins 2 - 3 hours
Cakes Small cakes Whisked sponge Swiss roll Victoria sandwich (2 x 180mm / 7") Genoise sponge Madeira (180mm / 7") Gingerbread Semi rich fruit cake (205mm / 8") Christmas cake (205mm / 8") Dundee cake (205mm / 8")	5 5 6 4 4 3 3 2 or 3 1 or 2 3	middle - top middle - top middle - top middle - top middle middle middle middle - bottom bottom middle - bottom	15 - 25 mins 20 - 25 mins 10 - 12 mins 20 - 30 mins 20 - 30 mins 1 - 1¼ hours 1 - 1¼ hours 2½ - 3 hours depending on recipe 2 - 2½ hour
Pastry Rough Puff Flaky / Puff Shortcrust Flan	7 6 6 6	middle - top middle - top middle - top middle - top	cooking time depends on recipe & type of filling
Biscuits Nut brownies Brandy snaps Flapjacks Ginger nuts	5 4 4 4	middle - top middle - top middle - top middle - top	25 - 35 mins 10 - 12 mins 20 - 25 mins 10 - 20 mins

USING THE OVENS

Traditional fruit cakes

It should be remembered that ovens can vary over time, therefore cooking times can vary, making it difficult to be precise when baking fruit cakes.

It is necessary therefore, to test the cake before removal from the oven. Use a fine warmed skewer inserted into the centre of the cake. If the skewer comes out clean, then the cake is cooked.

- Do not attempt to make Christmas cakes larger than the oven can cope with, you should allow at least 25mm (1 inch) space between the oven walls and the tin.
- Always follow the temperatures recommended in the recipe.
- To protect a very rich fruit cake during cooking, tie 2 layers of brown paper around the tin.
- We recommend that the cake tin is not stood on layers of brown paper, as this can hinder effective circulation of air.
- Do not use soft tub margarine for rich fruit cakes, unless specified in the recipe.
- Always use the correct size and shape of tin for the recipe quantities.

Roast turkey

Roasting turkey involves cooking two different types of meat - the delicate light breast meat, which must not be allowed to dry out, and the darker leg meat, which takes longer to cook.

The turkey must be roasted long enough for the legs to cook, so frequent basting is necessary. The breast meat can be covered once browned.

- Always make sure that the turkey is completely thawed and that the giblets are removed before cooking.
- Turkey should be roasted at gas mark 5 for 20 minutes per 1lb, plus 20 minutes, unless packaging advises otherwise.
- The turkey can be open roasted, breast side down, for half of the cook time, and then turned over for the remainder of the cooking time.
- If the turkey is stuffed, add 5 minutes per lb to the cooking time.
- If roasting turkey covered with foil, add 5 minutes per 1lb to the cooking time.

To test if the turkey is cooked, push a fine skewer into the thickest part of the thigh. If the juices run clear, the turkey is cooked. If the juices are still pink, the turkey will need longer cooking.

USING THE OVENS

Roasting guide

The times given in the roasting guide are only approximate, because the size and age of the bird will influence cooking times as will the shape of a joint and the proportion of the bone.

Frozen meat should be thoroughly thawed before cooking. For large joints it is advisable to thaw overnight.

Frozen poultry should be thoroughly thawed before cooking. The time required depends on the size of the bird - eg; a large turkey may take up to 48 hours to thaw.

Use of a trivet with a roasting tin will reduce fat splashing and will help to keep the oven interior clean. Alternatively, to help reduce fat splashing, potatoes or other vegetables can be roasted around the meat / poultry.

Notes:

- When cooking stuffed meat or poultry calculate the cooking time from the total weight of the meat plus the stuffing.
- For joints cooked in foil or covered roasters, and for lidded casseroles, add 5 minutes per 450g (1lb) to the calculated cooking time.
- Smaller joints weighing less than 1.25kg (2½lb) *may* require 5 minutes per 450g (1lb) extra cooking time.
- Position the oven shelf so that the meat or poultry is in the centre of the oven.
- It is recommended that the appliance is cleaned after open roasting.

Cook in oven at Gas Mark 5		Approximate Cooking Time (preheated oven)
Beef	Rare Medium Well done	20 minutes per 450g (1lb), plus 20 minutes 25 minutes per 450g (1lb), plus 25 minutes 30 minutes per 450g (1lb), plus 30 minutes
Lamb	Medium Well done	25 minutes per 450g (1lb), plus 25 minutes 30 minutes per 450g (1lb), plus 30 minutes
Pork		35 minutes per 450g (1lb), plus 35 minutes
Poultry		20 minutes per 450g (1lb), plus 20 minutes

USING THE OVEN

Automatic cooking

The automatic cooking facility is controlled by the programmer (see 'Programmer / Clock' section) and allows complete meals or individual dishes to be cooked while you are out of the house, to be ready for when you return.

The 'READY TIME' should be set as close as possible to - or just after - your anticipated return, so food is not left standing in a warm oven.

Do

- Select foods which are as fresh as possible, and as cold as possible - ie; preferably straight from the refrigerator.
- Choose foods which are suitable for cooking from a cold start, as some dishes will be affected by being left uncooked, at room temperature, perhaps for several hours - eg; a wet filling on a pastry base.
- Make sure that meat and poultry are thoroughly thawed (but still cold from the refrigerator) before placing them in the oven, and avoid using rolled joints of meat, which can be more susceptible to the growth of food poisoning organisms.
- Cover dishes with lids or foil to keep the food moist, and protect from possible contamination; the food can be uncovered towards the end of cooking to crisp and brown.

Do not

- Warm food should never be placed in the oven if there is a delay period.
- Stews prepared by frying the meat and vegetables first should be cooked as soon as possible, or refrigerated prior to placing in the oven.
- Some dishes are not suitable for cooking on automatic - eg; dishes containing left over meat or poultry, dishes containing eggs, cooked rice, or seafood.
- Do not put food items (intended for automatic cooking) into a warm oven. Allow the oven to cool before setting for automatic cooking.
- Do not over-fill dishes containing liquids, as they might boil over.
- Never leave food in the oven to cool slowly after cooking; serve immediately or cover and cool until the food is cold enough to refrigerate.
- Never use the automatic facility to reheat 'cook chill' foods, as they should go straight from the refrigerator into a preheated oven.
- To help keep food as cool as possible, do not leave the oven lights on when the oven is set for automatic cooking.

AUTOMATIC COOKING

Important:

Food is more susceptible to the growth of food poisoning organisms in warm conditions. If the weather is hot, either take care to ensure that food is not left standing in a warm oven, or avoid using the automatic cooking facility.

Hints for automatic cooking

- Food is placed in a cold oven so you will need to add about 10 - 15 minutes onto the cooking time to allow for the oven to reach the selected temperature.
- Wine or beer may ferment, and cream may curdle during the delay period, so it is best to add these ingredients just before serving.
- Potatoes should be parboiled or brushed with oil to prevent discolouration during the delay period.
- Meat can be brushed with oil to prevent it drying.
- Lemon juice can be added to certain fruit and vegetables such as apples, pears, turnips and parsnips to prevent discolouration during the delay period.

PROGRAMMER / CLOCK

The Programmer Buttons

- △ minute minder
- ⌘ cook time
- ⚡ ready time
- minus
- + plus

To set the "Time of Day"

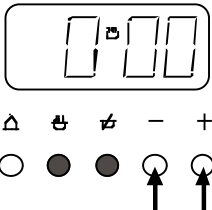

Press the *cook time* and *ready time* buttons simultaneously, and keep the buttons depressed. Use the *plus* and *minus* buttons to set the time of day, eg; 12.00.

A (Auto) symbol goes out, cookpot symbol comes on.

To select an alarm tone

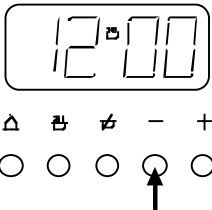

Press the *minus* button to listen to the first tone.

Release the *minus* button and press it again to listen to the second tone, etc.

Releasing the *minus* button after the tone has sounded will automatically select that tone.

Manual operation

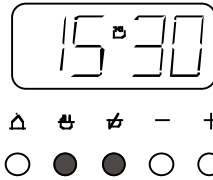

To set the programmer to manual operation at any time (cancelling any automatic setting), press the *cook time* and *ready time* buttons simultaneously. The programmer must be set to manual before the appliance can be used manually.

Setting the minute minder

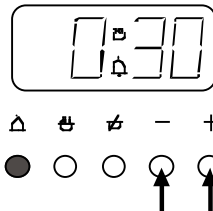

Press the *minute minder* button, then use the *plus* and *minus* buttons to set the required time.

The minute minder (bell) symbol will appear on the display.

You can cancel the minute minder at any time by pressing the *minute minder* button and the *minus* button until the display returns to 0.00.

After setting, the display will revert to show the time of day, but you can press the *minute minder* button, and the display will show the minutes remaining.

The tone will sound at the end of the time set - to cancel the tone, press the minute minder button.

PROGRAMMER / CLOCK

Semi-automatic cooking (example)

You have started cooking a meal or dish in the oven, and want to set the time for the oven to switch off.

Press the *cook time* button, then use the *plus* and *minus* buttons to set the display to show the length of cooking time required, eg; 2 hours as shown **(1)**.

After setting, the display will revert to show the time of day, but you can press the *cook time* button and the display will show how much cooking time still remains on the clock.

Press the *ready time* button, and the display will show the actual time the oven is going to switch off, eg; 18.00 as shown **(2)**.

At the end of the cooking time, the alarm will sound, and the oven will automatically switch off.

To switch off the alarm, press the *minute minder* button **(3)**.

When the oven has switched off, **return the oven control knob to the "off" position**, and press the *cook time* and *ready time* buttons to return to manual operation **(4)**.

If you wish to cancel the automatic setting, or to cancel any remaining cooking time left on the clock before the alarm sounds, press the *cook time* and *ready time* buttons simultaneously. **(4)**.

1. A (Auto) symbol appears.

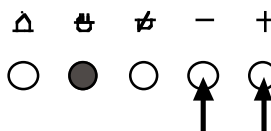
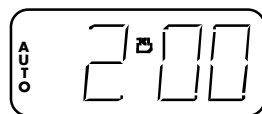

- 2.

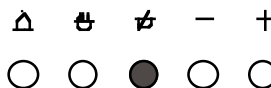

3. A (Auto) symbol will flash.

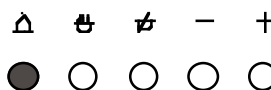

4. A (Auto) symbol goes out.

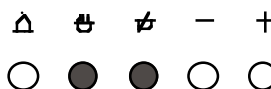

PROGRAMMER / CLOCK

Fully automatic cooking (example)

For use when a delayed start time is required.

You want to set the length of cooking time, and the time for the oven to switch off. The programmer will automatically calculate the cooking start time.

Press the *cook time* button, then use the *plus* and *minus* buttons to set the display to show the length of cooking time required, eg; 2 hours as shown (5).

Press the *ready time* button, and the present ready time will be displayed. Using the *plus* and *minus* buttons you can set the display to show the actual time you want the oven to switch off, eg; 18.00 hours (6.00 pm) (6).

The display will revert to show time of day.

After setting the programmer, turn the oven control to the required temperature.

The oven will automatically switch on at the calculated start time of 16.00 hours (4.00 pm) (7).

A single press of the *cook time* button shows the cooking time remaining before the oven automatically switches off (8).

5. A (Auto) symbol appears.

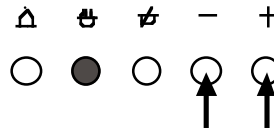
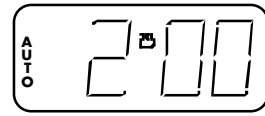

6. The cookpot symbol will disappear from display.

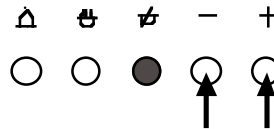

7. The cookpot symbol will appear on display.

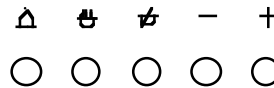
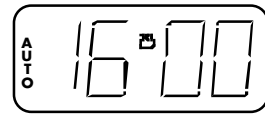

8.

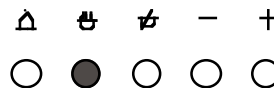
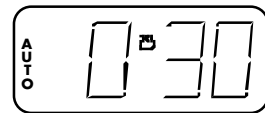

PROGRAMMER / CLOCK

The oven will automatically switch off at 18.00 hours (6.00 pm) and the alarm will sound (9).

9. A (Auto) symbol will flash.

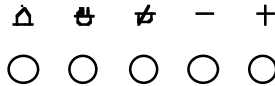
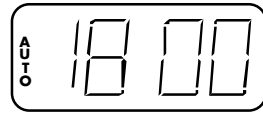

To switch off the alarm press the *minute minder* button (10).

- 10.

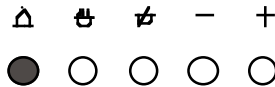
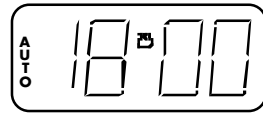

When the oven has switched off, return the oven control knob to the "off" position, and press the *cook time* and *ready time* buttons simultaneously (11).

11. A (Auto) symbol goes out.

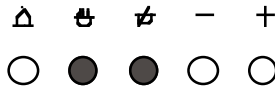

If you wish to cancel the automatic setting before cooking has started, and return to manual operation, press the *cook time* and *ready time* buttons simultaneously (11).

To cancel any remaining cooking time left on the clock before the alarm sounds, press the *cook time* and *ready time* buttons simultaneously (11).

CLEANING

Caution: Any cleaning agent used incorrectly may damage the appliance.

Always let the cooker cool before cleaning.

Some cooking operations generate considerable amount of grease, this combined with spillage can become a hazard if allowed to accumulate on the cooker through lack of cleaning. In extreme cases this may amount to misuse of the appliance and could invalidate your guarantee.

It is recommended that the appliance is cleaned after open roasting.

Do not use caustic pastes, abrasive cleaning powders, coarse wire wool or any hard implements, as they will damage the surfaces.

All parts of the appliance can be safely cleaned with a cloth wrung out in hot soapy water.

Painted, plastic & metal finish parts (where fitted)

OVEN DOOR FRAME & HANDLE, GRILL PAN HANDLE, FACIA PANEL & CONTROL KNOBS

Only use a clean cloth wrung out in hot soapy water.

Burner caps and heads

Important: Allow burners to cool before cleaning.

Caution: Hotplate burners can be damaged by soaking, automatic dishwashers (or dishwasher powders / liquids), caustic pastes, hard implements, coarse wire wool, and abrasive cleaning pastes.

Clean with a moist soapy pad - eg; "Brillo".

For the burners to work safely, the slots in the burner head where the flames burn need to be kept clear of deposit. Clean with a nylon brush, rinse, and dry thoroughly.

Important: The burner caps and heads must be repositioned correctly so that they sit squarely onto the hob as shown.

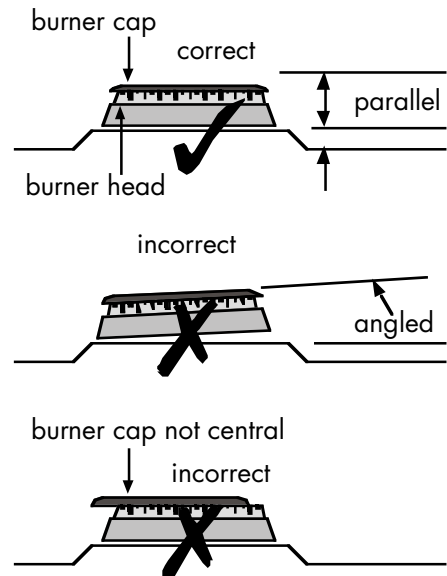

CLEANING

Easy care surfaces

MAIN OVEN SIDES AND BACK

We recommend that the appliance is cleaned after open roasting, and also after roasting at temperatures higher than gas mark 5, to help prevent a build up of fats. Use of a trivet in a roasting tin when roasting will help reduce fat splashing.

Caution: Most types of cleaning agent will damage these surfaces.

Only use a few drops of washing up liquid in hot water. Wipe the surfaces with a clean cloth wrung out in hot soapy water - if larger splashes of fat do not readily disappear, scrub the area with a nylon brush or nylon pan scourer and hot soapy water. Rinse well and heat the oven to dry the surfaces.

Vitreous Enamel parts

GRILL PAN, HOB TOP & PAN SUPPORTS, MAIN OVEN COMPARTMENT FLOOR, TOP OVEN COMPARTMENT

Use a mild cream cleaner - eg; "Cif".

Stubborn marks may be removed with a moistened "Brillo" pad.

The pan supports and grill pan may be cleaned in a dishwasher, or with a nylon brush in hot soapy water.

Glass parts

GLASS DOOR PANELS, LID GLASS

Do not use abrasives or polishes as they will scratch and damage the glass. Use a mild cream cleaner - eg; "Cif". Rinse away excess cleaner and dry with a soft cloth.

Warning: Do not operate the appliance without the glass panel correctly fitted.

Important: the inner door glass panel can be removed for cleaning but it must be replaced the right way up (so the reflective side - if fitted - faces inwards), and pushed fully in to the **stop** position. To remove the glass panel, open the door wide, hold the top and bottom edges and slide out.

Chrome plated parts

OVEN SHELVES & OVEN SHELF RUNNERS, GRILL PAN TRIVET

Do not use abrasives or polishes, use a moist soap pad - eg; "Brillo".

Note: Oven shelf runners can be removed for cleaning. Grasp the runners, and slide out of the hanging holes as shown.

Note: These items may also be cleaned in a dishwasher.

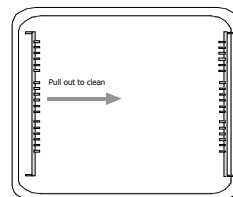

INSTALLATION INSTRUCTIONS

Before you start: Please read the instructions. Planning your installation will save you time and effort.

Prior to installation, ensure that the local distribution conditions (nature of the gas and gas pressure) and the adjustment of the appliance are compatible. The adjustment conditions are stated on the data badge.

This appliance is not connected to a combustion evacuation device. It shall be installed and connected in accordance with current installation regulation. Particular attention shall be given to the relevant requirements regarding ventilation.

In your own interest and that of safety, it is the law that all gas appliances be installed and serviced by competent persons. CORGI registered installers undertake to work to satisfactory standards.

Where regulations or standards have been revised since this handbook was printed, always use the latest edition.

In the UK the regulations and standards are as follows:

1. Gas Safety Regulations 1996 (Installation and Use).
2. Building Regulations - Issued by the Department of the Environment.
3. Building Standards (Scotland) (Consolidated) - Issued by the Scottish Development Department.
4. The current I.E.E. Wiring Regulations.
5. Electricity at Work Regulations 1989.
6. BS 6172 Installation of Domestic Gas cooking Appliances
7. Installation & Servicing Instructions for this appliance.

For installation in countries other than the UK, the appliance must be connected in accordance with all local gas and electrical regulations.

Ventilation Requirements

The room containing the appliance should have an air supply in accordance with BS 5440: Part 2: 1989:

- All rooms require an openable window, or equivalent, and some rooms will require a permanent vent as well.
- For room volumes up to 5m³ an air vent of 100cm² is required.
- If the room has a door that opens directly to the outside, or the room exceeds 10m³, NO AIR VENT is required.
- For room volumes between 5m³ and 10m³ an air vent of 50cm² is required.
- If there are other fuel burning appliances in the same room, BS 5440: Part 2: 1989 should be consulted to determine the air vent requirements.
- This appliance must not be installed in a bed sitting room of less than 20m³ or in a bathroom or shower room.

Windows and permanent vents should therefore not be blocked or removed without first consulting a CORGI gas installer.

Failure to install appliances correctly is dangerous and could lead to prosecution.

INSTALLATION INSTRUCTIONS

Whilst every care is taken to eliminate burrs and raw edges from this product, please take care when handling - we recommend the use of protective gloves during installation.

Moving the cooker

Please note that the weight of this appliance is approximately **60kg** (unpacked). Take care if the appliance needs to be lifted during installation - always use an appropriate method of lifting.

Do not attempt to move the cooker by pulling on the doors or handles. Open the door and grasp the frame of the cooker, taking care that the door does not shut on your fingers.

Take care to avoid damage to soft or uneven floor coverings when moving the appliance. Some cushioned vinyl floor coverings may not be designed to withstand sliding appliances without marking or damage.

Clearances & dimensions

Appliance dimensions

All sizes are nominal, and some variation is to be expected. The 'depth' of the cooker, as given below, is to the front of the door and excluding knobs and handles.

depth: 600mm

width: 600mm

height (adjustable): 900 - 915mm

height with lid raised: 1430 - 1445mm

Clearances

No shelf or overhang or cooker hood should be closer than a minimum of 650mm, but check with cooker hood manufacturer's recommendations.

The cooker must have a side clearance above hob level of 90mm up to a height of 400mm.

Check that there are no projections in the rear wall which will prevent the lid (where fitted) being raised to the vertical position.

To avoid damage to surrounding units a 10mm gap should be left between the appliance and the units. If this is not possible, a kit (part number 01 2552 00) may be ordered from Customer Care which will protect the units.

For models with side opening doors, we recommend a side clearance of 60mm between the cooker and any side wall to allow the door to be opened fully.

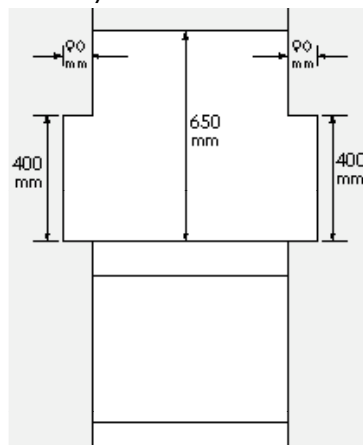

INSTALLATION INSTRUCTIONS

Stability bracket

If the cooker is fitted with a flexible connection, a stability bracket should be fitted to engage in the back of the cooker. A stability bracket can be bought from your local supplier.

A stability bracket can be fitted as follows:

1. Place the cooker in position and draw a PENCIL LINE level with the front edge.
2. Mark the centre of the cooker to give the CENTRE LINE for the bracket.
3. Remove the cooker and mark off 450mm from the PENCIL LINE to locate the front edge of the lower bracket.

4. Fix the bracket to the floor.

Measure from FLOOR LEVEL to ENGAGEMENT EDGE in the back of the cooker and add 3mm.

5. Assemble the underside of the top part of the bracket to this height.

Levelling

Place a spirit level on a baking sheet onto an oven shelf.

The cooker is fitted with levelling feet at the front and rear.

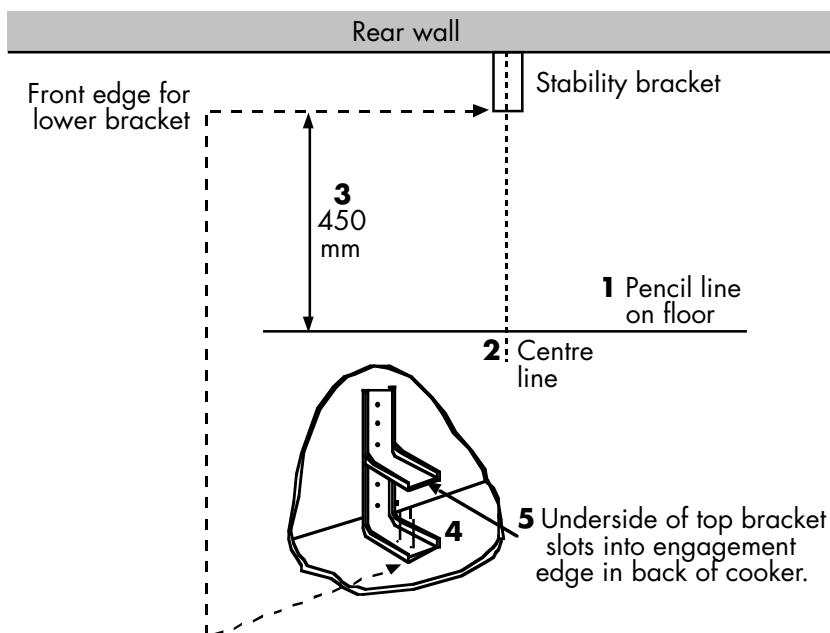

INSTALLATION INSTRUCTIONS

Connect to the electricity supply

Warning: This appliance must be earthed.

The flexible mains lead is supplied connected to a BS 1363 fused plug, having a fuse of 3 amp capacity.

If this plug does not fit the socket in your home, it should be replaced with a suitable plug as outlined below.

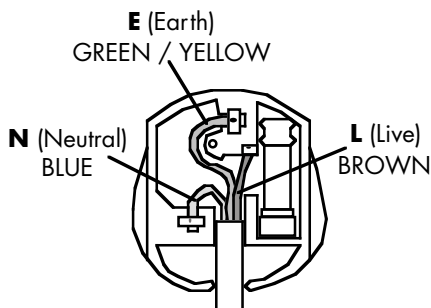

Use a **3 amp** fuse
in a 13 amp plug.

The wires in the mains lead are coloured in accordance with the following code:

Green and yellow = Earth,

Blue = Neutral,

Brown = Live.

As the colours of the wires in the mains lead for the appliance may not correspond with the coloured markings identifying the terminals in your plug, proceed as follows:

1. The wire which is coloured green and yellow must be connected to the terminal marked **E**  (Earth) or coloured Green.
2. The wire which is coloured blue must be connected to the terminal marked **N** (Neutral), or coloured Black.
3. The wire which is coloured brown must be connected to the terminal marked **L** (Live), or coloured Red.

The plug and socket must be accessible after installation.

Should the mains lead of the appliance ever require replacing, we recommend that this is carried out by a qualified electrician who will replace it with a lead of the same size and temperature rating.

Important: - ensure that you route all mains and electrical cables and flexible tubing well clear of any adjacent heat source.

INSTALLATION INSTRUCTIONS

Connect to the gas supply

The inlet to the cooker is ½" BSP internal situated at the rear right corner.

Fit the bayonet connection. This should be located so as to ensure that the flexible connector hose does not kink.

Use a 900mm - 1125mm length of flexible connector.

Ensure that all pipe work is of the correct rating for both size and temperature.

Flexible connections should comply with BS 669. Parts of the appliance likely to come into contact with a flexible connector have a temperature rise of less than 70°C.

After installation, make sure all connections are gas sound.

Commissioning

Burner aeration

All burners have fixed aeration and no adjustment is possible.

Pressure setting

G20 Natural Gas @ 20 mbar

Pressure test point

Use the oven injector.

Grill - Open the top compartment door before igniting the grill. Push in the control knob and turn clockwise to the grill setting., wait a second before pressing the ignition switch or holding a lighted match or taper to the burner.

Hob - Turn the control knob to the FULL ON position, wait a second before pressing the ignition switch or holding a lighted match or taper to the burner.

Ovens - Open the oven door. Turn the control to the FULL ON position and press the ignition switch, or holding a lighted match or taper to the burner. The burner operates at a low rate for up to 60 seconds until the flame supervision device opens & full gas rate is obtained.

Before leaving the installation

1. Place all the loose parts of the cooker into position.
2. Show the customer how to operate the cooker and give them this handbook. Thank you.

TECHNICAL DATA

Data badge - Lower part of front frame

Type of gas

This cooker must only be used with Natural Gas only, as specified on the appliance data badge.

Gas category

Natural Gas - I2H

Pressure setting

G20 Natural Gas @ 20 mbar

Pressure test point

Use the oven injector

Aeration

Fixed

Grill - Grill burner is surface combustion type. Spark gaps 3 - 4mm.

Hob - Burners have burner heads and caps which are removable for cleaning. Concealed electrodes to each burner.

Ovens - Oven burners are sheet steel, with pierced ports in stainless steel flame strip. *Spark Gap: 3 - 4mm. Flame supervision: Expansion type. Thermostat phial: Front centre of oven roof.*

Electrical supply

220 - 240V ~ 50Hz

Spark generator: Mains operated 7 outlet controlled by a single push button switch at the left hand side of the fascia to individual electrodes.

Warning: This cooker must be earthed.

Appliance class

Class 1, Freestanding

Countries of destination

GB - Great Britain, IE - Ireland

Gas	Burner	Nominal Rate Qn	Injector Size	Grammes per hour	
				Butane	Propane
Natural Gas	Grill	2.4kW	115	-	-
	Hob - LHF	1.0kW	77	-	-
	Hob - LHR & RHR	2.0kW	104	-	-
	Hob - RHF	3.0kW	130	-	-
	Main Oven	2.5kW	180 Amal	-	-
	Top Oven	1.75kW	110 Amal	-	-
	Maximum heat input	Qn 12.9kW	-	-	-
LP Gas	Grill	2.4kW	76	174g/h	172g/h
	Hob - LHF	1.0kW	50	73g/h	71g/h
	Hob - LHR & RHR	2.0kW	70	145g/h	143g/h
	Hob - RHF	3.0kW	87	218g/h	214g/h
	Main Oven	2.4kW	70 Amal	174g/h	172g/h
	Top Oven	1.75kW	50 Amal	127g/h	125g/h
	Maximum heat input	Qn 12.8kW	-	1056g/h	1040g/h

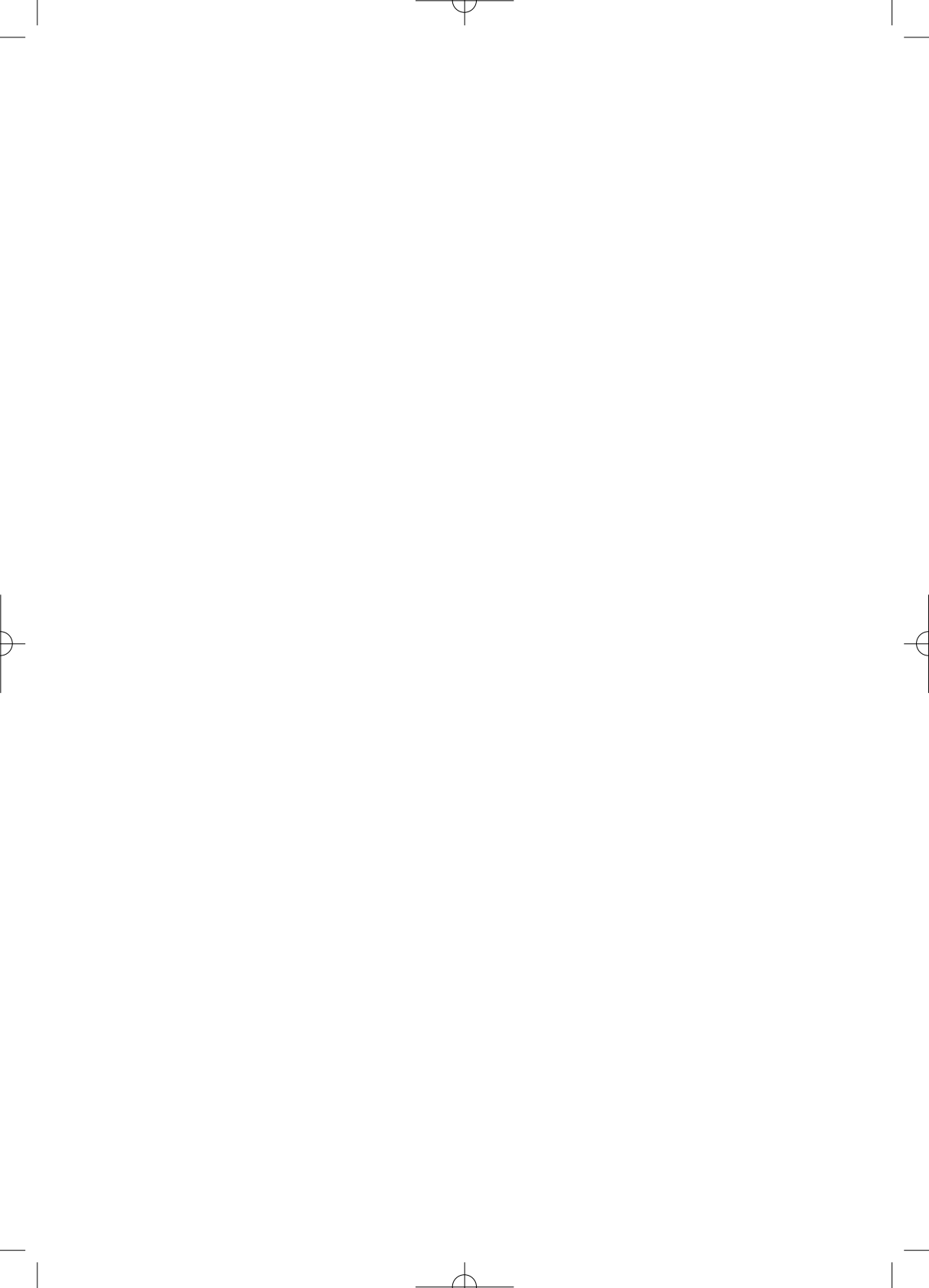

STOVES CUSTOMER CARE

In case of difficulty within the UK and Northern Ireland, please call
STOVES Customer Care Centre Helpline on

0870 444 9929

When you dial this number you will hear a recorded message and be given a number of options. This indicates that your call has been accepted and is being held in a queue. Calls are answered in strict rotation as our Customer Care Representatives become available.

Opening Hours for Customer Care Centre

Monday to Friday	8am - 8pm
Saturday	8.30am - 6pm
Sunday	10am - 4pm

Enter appliance numbers here for future reference:

Model No									
<input type="text"/>	<input type="text"/>	<input type="text"/>	<input type="text"/>	<input type="text"/>	<input type="text"/>	<input type="text"/>	<input type="text"/>	<input type="text"/>	<input type="text"/>
Serial No									
<input type="text"/>	<input type="text"/>	<input type="text"/>	<input type="text"/>	<input type="text"/>	<input type="text"/>	<input type="text"/>	<input type="text"/>	<input type="text"/>	<input type="text"/>

Please ensure you have the above details (Model No and Serial No) to hand when calling Stoves Customer Care. They are essential to booking your call.

Outside the UK and Northern Ireland, refer to your local supplier.



