

Waist Level Electric

600mm wide

**Freestanding Electric Double Oven & Grill
with Ceramic Hotplate**

User & Installation Handbook

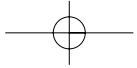
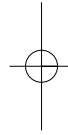
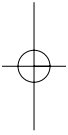

Contents

User's Section	2 - 20
Introduction	2
Be Safe - Not Sorry.	4
Using the Hob	5
Using the Grill	7
Using the Top Oven	9
Top oven baking guide	10
Using the Main Oven	11
Slow cooking.	12
Cooking with a fanned oven	13
Defrosting & cooling	14
Baking guide	15
Using the Ovens.	16
Traditional fruit cakes	16
Roasting turkey.	16
Roasting guide.	17
Minute Minder (if fitted)	18
Cleaning.	19
Installation Instructions.	21 - 22
Connect to electricity supply	22
Technical Data	23
Stoves Customer Care	24

Please keep this handbook for future reference, or for anyone else who may use the appliance.

Introduction

Thank you for choosing a British built appliance by Stoves

We hope the following information will help you to quickly familiarise yourself with the features of the appliance, and to use it successfully and safely.

Our policy is one of constant development and improvement. Strict accuracy of illustrations and specifications is not guaranteed. Modification to design and materials may be necessary subsequent to publication.

Please read the instructions in this handbook before using or installing this appliance.

Your new appliance is designed to be installed flush to base units.

Your 1st Year Guarantee

To fulfil the conditions of your guarantee, this appliance must be correctly installed and operated, in accordance with these instructions, and only be used for normal domestic purposes.

Please note that the guarantee, and Service availability, only apply to the UK and Republic of Ireland.

Before using the appliance for the first time, remove any protective polythene film and wash the oven shelves in hot soapy water, to remove their protective coating of oil. Even so, when you first turn on the oven or grill you may notice a smell and some smoke.

Electrical connections

Please refer to installation instructions for electrical connection.

In your own interest, and that of safety, make sure that the installation is carried out by a competent person.

Disconnection of electric appliances should always be carried out by competent persons.

Warning: This appliance must be earthed.

Moving the cooker

Do not attempt to move the cooker by pulling on the doors or handles. Open the door and grasp the frame of the cooker, taking care that the door does not shut on your fingers.

Take care to avoid damage to soft or uneven floor coverings when moving the appliance. Some cushioned vinyl floor coverings may not be designed to withstand sliding appliances without marking or damage.

Introduction

Glass door panels

To meet the relevant Standards of Domestic cooking appliances, all the glass panels on this appliance are toughened to meet the fragmentation requirements of BS3193. This ensures that, in the unlikely event that a panel breaks, it does so into small fragments to minimise the risk of injury.

Please take care when handling, using or cleaning all glass panels as any damage to the surfaces or edges may result in the glass breaking without warning or apparent cause at a later date. Should any glass panel be damaged, we strongly recommend that it is replaced immediately.

To replace an oven light bulb (if fitted)

Caution: Switch off the electricity supply to the appliance at the socket, to avoid the risk of electric shock.

Wait until the oven is cool, then remove the oven shelves.

Grasp the lens cover and pull away from the oven side. Unscrew the bulb.

Please note that the oven light bulb is not covered by guarantee.

Environmental Protection

Stoves Limited is committed to protecting the environment and operates an Environmental Management System which complies with BS EN ISO 14001:1996.

Disposal of packaging

- All our packaging materials are recyclable and environmentally friendly.
- Please help us to protect our environment by disposing of all packaging in an environmentally friendly manner.
- Please contact your local authority for the nearest recycling centre.

Caution: Packaging materials can pose a risk of suffocation - keep away from children.

Be Safe - Not Sorry

When you are cooking, keep children away from the vicinity of the appliance.

This product is designed as a domestic cooking appliance for the preparation and cooking of domestic food products, and should not be used for any other purpose.

- Remove all packaging, protective films and oils from the appliance before using for the first time.
- Make sure you read and understand the instructions before using the appliance.
- Keep electrical leads short so they do not drape over the appliance or the edge of the worktop.
- Keep all flammable materials (such as curtains, furnishings & clothing) away from the appliance.
- Parts of the appliance may be hot during or immediately after use. Care should be taken to avoid touching heating elements inside the oven. Allow sufficient time for the appliance to cool after switching off.
- Never use the appliance for heating a room.
- Do not drape tea towels over the flue vents or doors, as this creates a fire hazard.

- When opening the appliance door, take care to avoid skin contact with any steam which may escape from the cooking.
- Do not use aluminium foil to cover the grill pan, or put items wrapped in foil under the grill as this creates a fire hazard. The high reflectivity can also damage the element.
- Do not use the oven with the door inner glass panel removed (glass oven doors only).
- Use oven gloves when removing hot food / dishes from the oven or grill. The oven / grill and utensils will be very hot when in use.
- Do not use foil on oven shelves, or allow it to block the oven flue, as this creates a fire hazard and prevents heat circulation.
- When cooking heavy items - eg; turkeys - do not pull the oven shelf out with the item still on the shelf.
- Switch off the electricity supply before replacing the oven light bulb (if fitted), to avoid the risk of electric shock.

Warning: This appliance must be earthed.

When you have finished cooking check that all controls are in the off position.

Using the Hob

Caution: Do not use the hob if the glass is cracked, as electrical parts are directly beneath. To avoid the possibility of electric shock, turn off the electricity supply to the hob at the socket and arrange a Service call.

Before using the hob for the first time

Before using the hob for the first time, we recommend that you apply a thin coating of cleaner conditioner - eg; "Hob Brite" by Homecare*, and polish the surface with a clean dry cloth. Follow the instructions given in the cleaning section.

* Homecare products are available mail order - ☎ 0208 871 5027

To switch on the hob

Turn the hotplate selected control clockwise to the required setting. To switch off, return to the "off" position.

The hot hob light

The hot hob light comes on when one of the hotplates is switched on, and stays on for a short while after the last hotplate is switched off to indicate that the hob may still be warm.

Important:

- **Do not** use the ceramic glass hob as a work surface or chopping board, as it will damage it, and if any plastic utensils come into contact with a warm hob, they may melt onto it.
- Do not use the ceramic hotplate surface for storage.
- As pans are on a smooth surface, they will move easily if knocked accidentally; turning pan handles so they are not overhanging the edge of the hob, will help prevent this happening, and keep them out of the reach of children.
- **Be careful when cooking foods in salted water, or foods containing large amounts of sugar or syrup**, if they are spilt onto hot areas of the hob they may damage it.
Use pans which are large enough to avoid overflows onto the ceramic glass hob.
- Lift pans onto and off the hob, rather than sliding them across the surface, to avoid marks and scratches.
- Aluminium foil must not be placed on the hob as it will reflect any heat back into the element, which can damage it.
- Leaving a hotplate on for a length of time, without it being covered by a pan, can cause overheating of surrounding areas which could damage the glass.

Using the Hob

Using the hotplate / choice of pans

When cooking with fat or oil, never leave unattended.

Do not use double pans, rim based pans, old misshapen pans or any pan which is unstable when placed on a flat surface.

Turn pan handles to a safe position, so they are out of reach of children, not overhanging the appliance, and cannot be caught accidentally.

Use pans with a flat base of minimum 100mm / 4ins diameter and maximum 280mm / 11ins diameter which are stable in use.

Pan bases that are much smaller or much larger than the hotplate - eg; by 50mm - will result in slower cooking times.

Commercial simmering aids should not be used as they create excessive temperatures that can damage the surface and may cause a hazard.

When buying new pans, always refer to the pan manufacturer's guidelines.

For best results and energy efficiency it is important to use flat bottomed pans of the correct type, especially on ceramic glass hobs.

Always use pans which are large enough to prevent spillage, especially for deep frying, making jam or cooking with sugar or syrup based substances.

Trivets, round based woks, heat diffuser pads and over-sized pans are not recommended.

Avoid using double pans, or old misshapen

pans which are unstable and dangerous.

Cast iron, stainless steel, or enamelled steel pans are all suitable for use on ceramic glass and solid plate hobs.

Aluminium pans will give good cooking results but care must be taken in their use. If they are slid across the surface of a ceramic hob they tend to leave visible marks which can be difficult to remove.

Certain types of copper based pans may become slightly concave when heated, which can result in slower cooking times.

Pan bases should be thick, flat and smooth, to ensure maximum heat contact with the hob, maximum heat conduction and rapid cooking times.

Pans with dull or dark coloured bases will give the quickest cooking results.

Pans with thin, dented or ridge bases can result in very slow cooking times and should not be used.

Certain makes / brands of pressure cookers may not be suitable for use on ceramic hobs - they do not come to pressure. Stainless steel pressure cookers will give optimum results.

Pans with highly polished bases reflect heat back into the hob causing the ceramic hob hotplate to cycle on and off rapidly, which slows down cooking.

The right size of pan base will ensure maximum contact with the hob and rapid cooking times.

When you have finished cooking check that all controls are in the off position.

Using the Grill

Caution: Accessible parts may be hot when grill is used, young children should be kept away.

To switch on the grill

Open the grill door.

Turn the top oven control knob fully clockwise to the grill symbol.

The grill door must be **fully open** when grill is used.

To switch off, return the control knob to the "off" position.

Preheating

Always preheat the grill for about 3 minutes for best cooked results.

The cooling fan

When the grill is switched on, you will hear the cooling fan come on - this keeps the fascia and control knobs of the appliance cool during grilling only. The fan will continue to operate for a period after the grill control has been switched off.

Detachable grill pan handle

Place the handle over the edge of the grill pan. The handle should be removed from the pan during grilling, to prevent overheating.

The handle is designed for removing / inserting the grill pan under the grill when grilling.

If cleaning the grill pan when it is hot, use oven gloves to move it. *Do not* use the handle to pour hot fats from the grill pan.

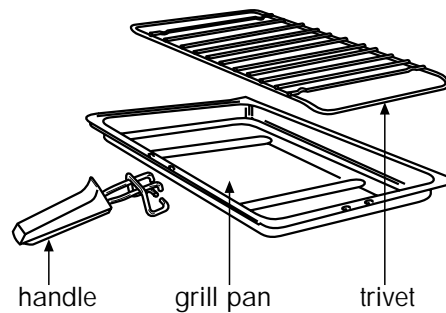

Grill pan trivet

Food for grilling should be placed within the area defined by the kinks in the trivet wires.

Using the Grill

Grilling

Grilling may be adjusted by changing the grill pan trivet position, as detailed below.

There are *three* different grilling positions, as the grill trivet - which is in the grill pan - may be inverted to give a high or low position or the trivet may be removed.

1. The HIGH trivet position is suitable for toasting bread.
2. The low trivet position is suitable for grilling all types of meat and fish.
3. With the grill trivet removed the food is placed directly on the base of the grill pan - eg; when cooking whole fish or browning dishes such as cauliflower cheese.

Grilling can also be adjusted by placing the shelf at a different position.

Aluminium foil

Using aluminium foil to cover the grill pan, or putting items wrapped in foil under the grill creates a fire hazard, and the high reflectivity may damage the grill element.

Using the Top Oven

Accessible parts may be hot when the oven is used. Young children should be kept away.

Important: Never put items directly on the base of the oven with foil, as this may cause the element to overheat. Always position items on the shelf.

Caution: The top element gets extremely hot when in use, so take extra care to avoid touching it.

To turn on the top oven

Turn the top oven / grill control knob to the required temperature setting.

The red thermostat indicator (if fitted) will come on until the selected temperature is reached and then go off; it will turn on and off periodically as the thermostat operates to maintain the selected temperature.

To switch off, return the control knob to the "off" position.

Preheating the top oven

The oven must be preheated when cooking frozen or chilled foods, and we recommend preheating for yeast mixtures, batters, soufflés and whisked sponges. Preheat the oven until the indicator light switches off for the first time - this will take up to 20 minutes depending on the temperature selected. If you are not preheating the oven, the cooking times in the baking guide may need to be extended, as they are based on a preheated oven.

When using the top oven

As part of the cooking process, hot air is expelled through a vent at the top of the oven(s). When opening the oven door, care should be taken to avoid any possible contact with potentially hot air, since this may cause discomfort to people with sensitive skin. We recommend that you hold the underneath of the oven door handle.

Top heat / base heat settings

The top oven offers the advantage that it can be used with either base heat only or top heat only, which are fixed heat settings.

Top heat only ("T" or)

Turn the top oven control past the oven temperature markings to the top heat symbol. This setting can be used to brown the top of dishes such as cauliflower cheese or baked alaska.

Base heat only ("B" or)

Turn the top oven control past the oven temperature markings to the base heat symbol. This setting can be used to finish cooking pastry bases, pies, pizzas etc.

The cooling fan

When the top oven is switched on, you will hear the cooling fan come on - this keeps the fascia and control knobs of the appliance cool during cooking only. The fan will continue to operate for a period after the oven control has been switched off.

Using the Top Oven

Top oven baking guide

Cooking times

These times are based on cooking in a preheated oven.

These cooking times are approximate, because the size and type of cooking dish will influence time as personal preferences.

Shelf positions

As a general guide, when cooking frozen or chilled food, use the highest possible shelf position, while allowing some clearance between the food and the top element. Follow the instructions given on packaging.

Cooking temperatures

The temperature settings and time given in the Baking Guides are based on dishes made with block margarine. If soft tub margarine is used, it may be necessary to reduce the temperature setting. If a recipe gives a different temperature setting to that shown in the guide, the recipe instruction should be followed.

Because the top oven is more compact, it may be necessary to reduce cooking temperatures specified in recipes by up to 20°C.

Use the baking guide as a reference for determining which temperatures to use.

Item	Temperature °C	Shelf position	Approximate cooking time
Small cakes	180	middle	15 - 20 mins
Victoria sandwich (2 x 180mm / 7")	160	middle	20 - 25 mins
Swiss roll	200	middle	8 - 12 mins
Semi rich fruit cake (180mm x 7")	140	bottom	2¼ - 2¾ hours
Scones	215	top	10 - 15 mins
Meringues	90 - 100	top	2 - 3 hours
Shortcrust pastry	200 - 210	middle	Depends on size & type of cooking dish & also the filling
Puff / flaky pastry	200 - 210	middle	
Choux pastry	200 - 210	middle	
Biscuits	160 - 200	top	10 - 20 mins
Sponge pudding	150	middle	30 - 45 mins
Milk pudding	140	bottom	2 - 2½ hours

Using the Main Oven

Accessible parts may be hot when the oven is used. Young children should be kept away.

To switch on the oven

Turn the oven control knob clockwise to the required setting.

The red thermostat indicator (if fitted) will come on until the selected temperature is reached and then go off; it will turn on and off periodically as the thermostat operates to maintain the selected temperature.

To switch off, return the control knob to the "off" position.

When using the oven

As part of the cooking process, hot air is expelled through a vent at the top of the oven(s). When opening the oven door, care should be taken to avoid any possible contact with potentially hot air, since this may cause discomfort to people with sensitive skin. We recommend that you hold the underneath of the oven door handle.

Preheating

The oven **must** be preheated when cooking frozen or chilled foods, and we recommend preheating for yeast mixtures, batters, soufflés and whisked sponges.

Preheat the oven until the indicator light (if fitted) switches off for the first time, this will take up to 20 minutes, depending on the temperature selected.

If you are not preheating the oven, the cooking times in the following guide may need to be extended, as they are based on a preheated oven.

Using the Main Oven

Oven shelves

The oven shelf must be positioned with the upstand at the rear of the oven and facing upwards.

Position baking trays and roasting tins on the middle of the shelves, and leave one clear shelf position between shelves, to allow for circulation of heat.

Baking tray and roasting tins

For best cooked results and even browning, the maximum size baking trays and roasting tins that should be used are as follows;

Baking tray 350mm x 280mm

This size of baking tray will hold up to 20 small cakes.

Roasting tin 370mm x 320mm

We recommend that you use good quality cookware. Poor quality trays and tins may warp when heated, leading to uneven baking results.

Slow cooking

- Make sure that frozen foods are thoroughly THAWED before cooking.
- Do not slow cook joints of meat or poultry weighing more than 2¼kg / 4½lb.
- For roasting joints of meat or poultry, and for pot roasts preheat the oven to 190°C and cook for 30 minutes, then adjust the oven control to the 110°C - 120°C (slow setting) for the remainder of the cooking time.
- Slow cooking times will be about 3 times as long as conventional cooking times.

Using the Main Oven

Cooking with a fanned oven

If you are used to cooking with a conventional oven you will find a number of differences to cooking with a fan oven which will require a different approach:

There are no zones of heat in a fan oven as the convection fan at the back of the oven ensures an *even temperature* throughout the oven. This makes it ideal for batch baking - eg; when planning a party or stocking the freezer - as all the items will be cooked within the same length of time.

Foods are cooked at a *lower temperature* (between 10°C and 20°C lower) than a conventional oven, so conventional recipe temperature may have to be reduced.

Preheating is generally not necessary as a fan oven warms up quickly.

There is no flavour transference in a fan oven, which means you can cook strong smelling foods such as fish at the same time as mild foods - eg; milk puddings.

When batch baking foods that will rise during cooking - eg; bread - always ensure that enough space has been left between the shelves to allow for the rise.

Notes:

When 2 or more shelves are being used, it may be necessary to increase the cooking time slightly.

Because the 2 oven shelves are wider than in many ovens, it is possible to cook 2 items per shelf - eg; 2 victoria sandwiches or 2 casseroles.

Although you need to keep in mind the points '*To help the air circulate freely*' with careful choice of dishes and tins, it is possible to cook a complete meal, and perhaps something else for the freezer, in the oven at the same time.

When roasting meats, you will notice that fat splashing is reduced, which is due in part to the lower oven temperatures, and will help keep cleaning of the oven to a minimum.

Because a fan oven has an even temperature throughout the oven, there is no need to follow the shelf positions given in the baking guide. There is no need to interchange dishes onto different shelves part way through cooking, as with a conventional oven.

To help the air circulate freely

Position the shelves evenly within the oven and maintain a clearance from the oven roof and base.

If more than one cooking dish or baking tray is to be used on a shelf, leave a gap of at least 25mm between the items themselves and the oven interior.

Allow enough space between shelves for food that will rise during cooking.

Do not place items on the oven base as this will prevent air circulating freely.

Using the Main Oven

Defrosting and cooling in the main oven

To **defrost** frozen foods, turn the main oven control to the defrost position, place the food in the centre of the oven and close the door.

To **cool** foods after cooking prior to refrigerating or freezing, turn the main oven control to the defrost position and open the door.

Defrosting times

Small or thin pieces of frozen fish or meat - eg; fish filets, prawns & mince will take approximately 1 - 2 hours.

Placing the food in a single layer will reduce the thawing time.

A medium sized casserole or stew will take approximately 3 - 4 hours.

A 1½kg / 3lb oven ready chicken will take approximately 5 hours, remove the giblets as soon as possible.

Be safe

Do not defrost stuffed poultry using this method.

Do not defrost larger joints of meat and poultry over 2kg / 4lb using this method.

Never place uncooked food for defrosting next to cooked food which is to be cooled, as this can lead to cross contamination.

Defrosting meat, poultry, and fish can be accelerated using this method but make sure they are completely thawed before cooking thoroughly. Place meat and poultry on a trivet in a meat tin.

Using the Main Oven

Main oven baking guide	Temperature at °C	Approximate cooking time
Item	Fanned	(preheated oven)
Small cakes	175	15 - 25 mins
Whisked sponge	170	20 - 25 mins
Swiss Roll	190	10 - 12 mins
Victoria Sandwich (2 x 205mm / 8in)	160	20 - 30 mins
Semi rich fruit cake (180mm / 7in)	125	2½ - 3 hours
Scones	210	10 - 15 mins
Meringues	90 - 100	2½ - 3 hours
Shortcrust pastry	200	depending on size
Puff / Flaky pastry	210	& type of dish
Choux pastry	200	& type of filling
Biscuits	160 - 200	20 - 30 mins
Sponge pudding	150	45 mins - 1 hour
Milk pudding	150	1½ - 1¾ hours

Cooking times & temperatures

The temperature settings and times given in the baking guide are based on dishes made with block margarine. If soft tub margarine is used it may be necessary to reduce the temperature setting.

If a recipe gives a different temperature setting to that shown in the guide, the recipe instruction should be followed.

The times given in the baking guide are based on cooking in a preheated oven.

Aluminium foil

Use foil only to cover food or cooking dishes, using foil to cover the shelves or oven base creates a fire hazard.

Using the Ovens

Traditional fruit cakes

It should be remembered that ovens can vary over time, therefore cooking times can vary, making it difficult to be precise when baking fruit cakes.

It is necessary therefore, to test the cake before removal from the oven. Use a fine warmed skewer inserted into the centre of the cake. If the skewer comes out clean, then the cake is cooked.

- Do not attempt to make Christmas cakes larger than the oven can cope with, you should allow at least 25mm (1 inch) space between the oven walls and the tin.
- Always follow the temperatures recommended in the recipe.
- To protect a very rich fruit cake during cooking, tie 2 layers of brown paper around the tin.
- We recommend that the cake tin is not stood on layers of brown paper, as this can hinder effective circulation of air.
- Do not use soft tub margarine for rich fruit cakes, unless specified in the recipe.
- Always use the correct size and shape of tin for the recipe quantities.

Roast turkey

Roasting turkey involves cooking two different types of meat - the delicate light breast meat, which must not be allowed to dry out, and the darker leg meat, which takes longer to cook.

The turkey must be roasted long enough for the legs to cook, so frequent basting is necessary. The breast meat can be covered once browned.

- Always make sure that the turkey is completely thawed and that the giblets are removed before cooking.
- Turkey should be roasted at 170°C - 190°C for 20 minutes per lb, plus 20 minutes, unless packaging advises otherwise.
- The turkey can be open roasted, breast side down, for half of the cook time, and then turned over for the remainder of the cooking time.
- If the turkey is stuffed, add 5 minutes per 1lb to the cooking time.
- If roasting turkey covered with foil, add 5 minutes per 1lb to the cooking time.

To test if the turkey is cooked, push a fine skewer into the thickest part of the thigh. If the juices run clear, the turkey is cooked. If the juices are still pink, the turkey will need longer cooking.

Using the Ovens

Roasting guide

The times given in the roasting guide are only approximate, because the size and age of the bird will influence cooking times as will the shape of a joint and the proportion of the bone.

Frozen meat should be thoroughly thawed before cooking. For large joints it is advisable to thaw overnight.

Frozen poultry should be thoroughly thawed before cooking. The time required depends on the size of the bird - eg; a large turkey may take up to 48 hours to thaw.

Use of a trivet with a roasting tin will reduce fat splashing and will help to keep the oven interior clean. Alternatively, to help reduce fat splashing, potatoes or other vegetables can be roasted around the meat / poultry.

Notes:

- When cooking stuffed meat or poultry calculate the cooking time from the total weight of the meat plus the stuffing.
- For joints cooked in foil or covered roasters, and for lidded casseroles, add 5 minutes per 450g (1lb) to the calculated cooking time.
- Smaller joints weighing less than 1.25kg (2½lb) may require 5 minutes per 450g (1lb) extra cooking time.
- Position the oven shelf so that the meat or poultry will be in the centre of the oven.
- It is recommended that the appliance is cleaned after open roasting.

Cook in oven at: 180°C - Main Oven (Fanned) 200°C - Top Oven (Conventional)		Approximate Cooking Time (preheated oven)
Beef	Rare Medium Well done	20 minutes per 450g (1lb), plus 20 minutes 25 minutes per 450g (1lb), plus 20 minutes 30 minutes per 450g (1lb), plus 30 minutes
Lamb	Medium Well done	25 minutes per 450g (1lb), plus 25 minutes 30 minutes per 450g (1lb), plus 30 minutes
Pork		35 minutes per 450g (1lb), plus 35 minutes
Poultry		20 minutes per 450g (1lb), plus 20 minutes

Minute Minder (if fitted)

Initial display

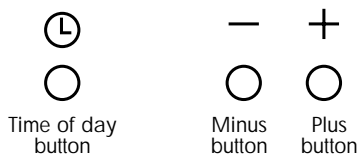
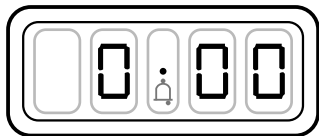

The digital timer enables you to set the time of day (24 hour clock) and the minute minder alarm.

Setting the "Time of Day"

1. Switch on the electricity supply to the appliance.
The display will flash.
2. Press and release the *time of day* button.
3. Set the time of day with the *plus* and *minus* buttons.
4. The time will be set 7 seconds after the last plus or minus operation.

Alarm tones

After setting the time of day, you can select one of three alarm tones.

Press the *minus* button to listen to the first tone, then release the *minus* button and press it again to listen to the second tone, etc.

Releasing the *minus* button after a tone has sounded will automatically select that tone.

Setting the minute minder

1. Press and release the *plus* button to change the display from clock to minute minder - the bell symbol will light.
2. Use the *plus* and *minus* buttons to set the length of time before the alarm tone will sound. The display will increase / decrease in units of 10 seconds up to 99 minutes 50 seconds, and in units of 1 minute from 1 hour 40 minutes upwards. The maximum period which may be set is 10 hours.

The display format will change after 99 minutes and 50 seconds to 1 hour and 40 minutes.

During countdown, the minute minder has priority on the display, which will show (in *minutes : seconds*, or *hours : minutes*) the time remaining.

When countdown is complete, the tone will sound for 7 minutes, or it can be reset with one touch of any button.

To cancel the minute minder at any other time, run down the set time with the *minus* button.

The display will revert to show the time of day.

Cleaning

Caution: Any cleaning agent used incorrectly may damage the appliance.

Always let the appliance cool before cleaning.

Some cooking operations generate a considerable amount of grease. This, combined with spillage, can become a hazard if allowed to accumulate on the cooker through lack of cleaning. In extreme cases this may amount to misuse of the appliance and could invalidate your guarantee.

It is recommended that the appliance is cleaned after open roasting.

Do not use caustic pastes, abrasive cleaning powders, coarse wire wool or any hard implements, as they will damage the surfaces.

All parts of the hob can be safely cleaned with a cloth wrung out in hot soapy water.

Chrome plated parts

OVEN SHELVES & OVEN SHELF RUNNERS,
GRILL PAN TRIVET

Do not use abrasives or polishes, use a moist soap pad - eg; "Brillo".

Oven shelf runners can be removed for cleaning. Grasp the runners, and slide out of the hanging holes as shown.

Note: These items may also be cleaned in a dishwasher.

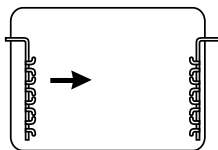

Vitreous Enamel parts

GRILL PAN, TOP OVEN / GRILL COMPARTMENT,
MAIN OVEN COMPARTMENT BASE

Use a mild cream cleaner - eg; "Cif".

Stubborn marks may be removed with a moistened "Brillo" pad.

The pan supports and grill pan may be cleaned in a dishwasher, or with a nylon brush in hot soapy water.

Easy care surfaces (if fitted)

MAIN OVEN SIDES AND BACK

We recommend that the appliance is cleaned after open roasting, and also after roasting at temperatures higher than 200°C, to help prevent a build up of fats. Use of a trivet in a roasting tin when roasting will help reduce fat splashing.

Caution: Most types of cleaning agent will damage these surfaces.

Only use a few drops of washing up liquid in hot water. Wipe the surfaces with a clean cloth wrung out in hot soapy water - if larger splashes of fat do not readily disappear, scrub the area with a nylon brush or nylon pan scourer and hot soapy water. Rinse well and heat the oven to dry the surfaces.

Painted, plastic & metal finish parts (if fitted)

DOOR HANDLE, FACIA PANEL & CONTROL KNOBS

Only use a clean cloth wrung out in hot soapy water.

Cleaning

Glass parts (if fitted)

GLASS DOORS

Do not use abrasives or polishes as they will scratch and damage the glass.

Use a mild cream cleaner - eg; "Cif". Rinse away excess cleaner and dry with a soft cloth.

The oven door inner glass panel (if fitted) can be removed for cleaning by grasping the top and bottom edges and sliding out. When refitting, take care that the glass is held level and straight with the grooves in the door, before sliding back in.

Ceramic glass hotplate

Do not use abrasive powder cleaners, "Brillo" pads, metal wire, detergents, bleaches, bath stain removers, or chemical oven cleaners; all these product types will damage the ceramic glass.

The following recommendations will help to keep the ceramic glass surface bright and clean.

Allow the hob to cool.

Use a dampened paper towel or clean damp cloth to apply a small dab of cleaner conditioner to clean each heating area.

Use another paper towel or a clean dry soft cloth to wipe dry, and then polish the whole glass surface.

To remove any stubborn marks or heavy soiling, a non scratching, mild cream cleaner may be used - eg; "Cif". Alternatively, a ceramic hob scraper may be used (available from Homecare*).

Important: If you use a wet paper towel or clean damp cloth to remove spillage from a warm heating area of the hob, be careful to avoid steam burns.

Care and maintenance

Before using the hob for the first time, apply a thin coating of cleaner conditioner (eg; "Hob Brite", by Homecare*) to the ceramic glass, and polish the surface with a clean cloth.

The conditioner gives a protective covering to the ceramic glass which not only makes the hob easier to clean, but also ensures that you will gain maximum life out of this product. Occasional use will help prevent the build up of mineral deposits which can cause discolouration of the hob surface.

Discolouration of the hob

Do not use a dishcloth or dish sponge to wipe the hob - this can leave a film of detergent on the surface which will discolour the hob next time a heating area is used. Clean cloths kept for the cleaning of the hob can be used.

Do not use too much cleaner conditioner - only a thin coating is required, any excess may burn on and discolour the hob when it is next in use.

If persistent stains or marks remain on the ceramic glass surface, it can be cleaned using a mild cream cleaner - eg; "Cif" - or a ceramic hob scraper. This will also remove any accumulated salts or minerals before they have an opportunity to discolour the ceramic glass.

Wipe clean with a damp paper towel or clean damp cloth and re-apply cleaner conditioner.

- Homecare products are available mail order from ☎ 0208 871 5027.

Installation Instructions

Whilst every care is taken to eliminate burrs and raw edges from this product, please take care when handling - we recommend the use of protective gloves during installation.

Moving the cooker

Please note that the weight of this appliance is approximately **55kg** (unpacked). Take care if the appliance needs to be lifted during installation - always use an appropriate method of lifting.

Do not attempt to move the cooker by pulling on the doors or handles. Open the door and grasp the frame of the cooker, taking care that the door does not shut on your fingers.

Take care to avoid damage to soft or uneven floor coverings when moving the appliance. Some cushioned vinyl floor coverings may not be designed to withstand sliding appliances without marking or damage.

This is a type X appliance regarding installation requirements.

Important: Ensure that you route all mains cables well clear of any adjacent heat source.

Clearances

This cooker may be fitted flush to base units. However, for models with side opening doors, we recommend a side clearance of 60mm between the cooker and any side wall to allow the door to be opened fully.

No shelf or overhang or cooker hood shall be closer than a minimum of 650mm, but check with cooker hood manufacturer's recommendations.

The cooker must have a side clearance above hob level of 90mm up to a height of 400mm.

Dimensions

All sizes are nominal, and some variation is to be expected. The 'depth' of the cooker, as given below, is to the front of the door and excluding knobs and handles.

Width:	600mm
Depth:	600mm
Height (adjustable):	900 - 915mm

Installation Instructions

Connect to the electricity supply

Warning: This appliance must be earthed.

The appliance must be installed by a competent electrician using a double pole control unit of 30 ampere minimum capacity with 3mm minimum contact separation at all poles.

We recommend that the appliance is connected by a qualified electrician who is a member of the N.I.C.E.I.C. and who will comply with the I.E.E. and local regulation.

1. Access to the mains terminal is gained by opening the terminal block cover at the rear of the appliance (use a small flat-bladed screwdriver).
2. Connection should be made with 6.0mm² twin and earth cable.
3. First strip the wires, then push the cable through the cable clamp in the terminal block cover.
4. Connect the cable to the terminal block and tighten the cable clamp screw (see diagram).
5. Close the terminal box, ensuring that the cover is engaged on the locking tabs.

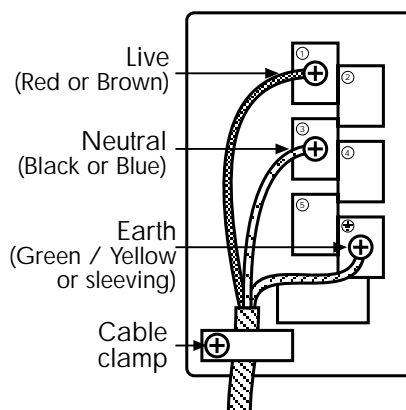

Technical Data

Data badge

On the bottom of the front frame
behind the oven door.

Electrical supply

230 - 240V ~ 50Hz

Warning: This appliance must be
earthed.

Electrical ratings

Main fanned oven	1670W
Conventional top oven	1285W
Grill	1725W
Hotplate	2 x 1725W
Hotplate	2 x 1150W
Oven lamp(s)	each 25W
Cooling fan	10W
Oven stir fan (main oven)	30W

Maximum load

Models with 1 oven lamp	9210W
Models with 2 oven lamps	9235W

Countries of Destination

GB - Great Britain, IE - Ireland

Stoves Customer Care

In case of difficulty within the UK and Northern Ireland, please call
Stoves Customer Care Centre Helpline on

0151 432 7838

When you dial this number you will hear a recorded message and be given a number of options. This indicates that your call has been accepted and is being held in a queue. Calls are answered in strict rotation as our Customer Care Representatives become available.

Opening Hours for Customer Care Centre

Monday to Friday	8am - 8pm
Saturday	8.30am - 6pm
Sunday	10am - 4pm

Enter appliance numbers here for future reference:

Model No
<input type="text"/> <input type="text"/> <input type="text"/> <input type="text"/> <input type="text"/> <input type="text"/> <input type="text"/> <input type="text"/> <input type="text"/>
Serial No
<input type="text"/> <input type="text"/> <input type="text"/> <input type="text"/> <input type="text"/> <input type="text"/> <input type="text"/> <input type="text"/> <input type="text"/>

Please ensure you have the above details (Model No and Serial No) to hand when calling Stoves Customer Care. They are essential to booking your call.

Outside the UK and Northern Ireland, refer to your local supplier.

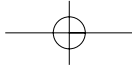
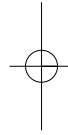

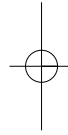

STOVES LIMITED
STONEY LANE, PRESCOT, MERSEYSIDE, L35 2XW

08 23480 03 © 2002
RS2

