

Accolade[™]

S7 - E600MF

600mm Built In Electric Multifunction Oven & Grill

Contents

About your Appliance	3
Before Use	4
Using your Oven – Icons	6
Using the Clock / Programmer	7
Defrosting food	13
SteamCleanse	14
Using your Grill	15
Using your Oven	16
Meat Sensor	17
Cooking Guide – Notes	19
Cooking Guides:	
• Starters	20
• Fish	21
• Meats	22
• Sweets	23
Care and Cleaning	25
Maintenance	28
Troubleshooting	29
Installation	30
Technical Data	36
Service record	38

About your Appliance: S7 - E600MF

Fascia layout

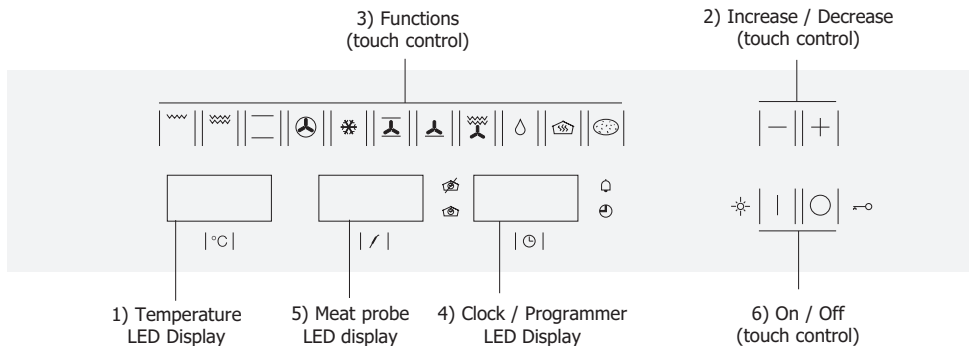



What is it?	What does it do?
1) The temperature display	Displays the temperature when the oven is in use.
2) Increase (+) & Decrease (-)	Used to increase or decrease the temperature (°C), or to increase or decrease the time when using the minute minder or automatic programmer.
3) The function icons	Turn to select the function which best suits the food you are cooking.
Use the function selector and the temperature selector together to switch the oven off and on.	
4) The clock / programmer LED display	The display shows the current time of day. The Minute Minder or Automatic Programmer shows the remaining time when selected.
5) The Meat probe indicator LED display	When the meat probe function is in use, the required temperature will be displayed in this window. Using the increase / decrease will adjust this temperature if required.
6) The On / Off icons which include these features: The lock Oven lights	Touching the ○ icon switches the appliance OFF and LOCKS the appliance. Touching the icon switches the appliance ON and also illuminates the oven LIGHTS ONLY.

Before Use

Carefully read this Instruction Manual before use to get the best results from your oven.

Before using the appliance for the first time, we recommend that you follow the instructions below:

- Remove all the packaging material, including the protective plastic, if included.
- Select the  or  function at 200 °C for one hour.
- Allow the oven to cool.
- The appliance and any furniture included should be thoroughly cleaned before use to remove any oils or residue left behind by the manufacturing process.
- During the first use, fumes and odours may occur and the kitchen should therefore be well ventilated.

Ecological Packaging

The packaging materials are completely recyclable and can be used again. Check with your local authority on the regulations for disposing of this material.

Disposing of old appliances

The symbol  on the product or on its packaging indicates that this product may not be treated as household waste, and should be disposed of carefully. By ensuring this product is disposed of correctly, you will help to prevent damage to the environment and human health, which could be caused by inappropriate waste handling.

Please make arrangements for the product to be transported to your local recycling centre.

Your local council, household waste disposal service or the retailer you purchased this appliance from can supply you with information about recycling facilities in your area.

Before Use

Electrical Safety

- Any repairs must be carried out by an authorised Service Engineer, using original spare parts. Failure to do so may invalidate any warranty, as well as cause damage to your appliance.
- Unplug your oven if it breaks down, and do not use it until a Service Engineer visit has taken place, or you have been advised that it is safe by a Customer Care Advisor.

Safety Notes

- The oven **MUST NOT** be operated with the door open.
- The appliance is not intended for use by young children or infirm persons without supervision.
- This appliance is to be used for **domestic cooking purposes** only.
- Only use the oven when it is installed within kitchen units.
- Do not use the oven as a storage space - it could be dangerous if the oven is switched on.
- Do not lean, sit or place food on the open door of the oven.
- Do not cover the bottom of the oven with aluminium foil.
- Always use the side guides to support the oven trays and racks when the oven is in use. The trays and shelves use a sliding mechanism which allows them to be extracted safely.
- Do not put containers or food on the floor of the oven. Always use the trays and grids.
- While using the oven, open the door as little as possible to maintain the temperature inside.
- When moving or removing hot dishes, make sure you wear protective oven gloves.
- It is not unusual for condensation to form on the door while the oven is in use - this is most common with foods which have a high moisture content.



Parts of the appliance become hot while in use. Always make sure that children are supervised when they are near to the appliance.













Call Customer Care for a service engineer's visit if:

- You find over a period of time that the oven becomes hotter at a particular temperature - the thermostat may need replacing.
- The cooling fan fails to work.



Tip: Use the Minute Minder when cooking.

Using Your Oven – Icons

Icon	What it is
	Single variable grill Used for grilling smaller amounts of food - only half of the grill element is used.
	Variable Dual Grill Used for grilling larger amounts of food as the whole grill element is used.
	Conventional oven (top + bottom heat) Used for general cooking purposes and suits most recipes.
	Fanned oven Used for general cooking purposes. Provides an even heat throughout the oven, which is useful for batch baking. You may find that you need to reduce the temperature setting for recipes, or reduce the cooking time as this is a very efficient heat setting.
	Defrost Uses the fan only (no heat). Ideal for defrosting frozen deserts and joints of meat.
	Intensive bake (top, bottom + fanned) Uses all elements, plus the fan. Best use is for baking with pastry cases as it eliminates the need to bake blind.
	Base heat + fan Use for baking pastry dishes which require a crisp base, but have a moist filling which should not dry out.
	Grill + fan Used for grilling foods. The fan circulates the heat quickly around the food – and eliminates the need for turning on foods such as bacon which a thinly sliced.
	SteamCleanse Oven cleaning function. See "SteamCleanse" section for more information.
	Slow Cook A low temperature function which is used to cook foods for a lengthy period. Produces very tender results with pot roasts etc.
	Pre-set cooking setting (Pizza) Used for cooking Pizza. Preset optimum temperature ensures best results.



When using the fanned oven function for cooking, we recommend either reducing the temperature setting by around 10C, or reduce the recipe time by around 10 minutes – however, please bear in mind that all cooking results are based on personal preference and taste.

NOTE:

To use slow cook set the 'slow cook' function by touching the icon and set the cooking time on the timer.

CAUTION:

When using ANY of the grill functions the door **MUST** remain closed.

Using The Programmer / Clock

Your touch control electronic clock / programmer has the following functions, in addition to being a clock. Further details are given in this section of the handbook.

Minute minder:

Creates an alarm signal when the period of time finishes; the oven does not need to be in use in order to use this function.

Cooking Time:

To cook for a selected length of time; the oven turns off automatically when the time finishes.

End Cooking Time:

To cook until a set time; the oven turns off automatically when the time is reached.

Automatic Programmer (Cook time + End Time):

To cook for a selected length of time and end at a set time. When this function is set, the oven comes on automatically at the time required in order to cook for the set length of time (Cook time) and end automatically at the indicated time (End Time).

Oven Lighting:

The lights inside the oven are designed to illuminate the cavity interior when a cooking function is selected. Once the oven function is set the lights will extinguish after a set period of time.

If you wish to turn the oven lights back on during cooking simply press the 'Oven On' icon. | |



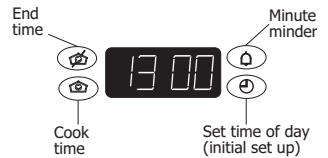

Note: If your finger remains on this icon for a short period of time the light will remain on throughout the cooking process.

i This is a 24 hour clock. Before you use your appliance for the first time, you **must** ensure that the time of day is set.

i What your timer symbols mean



Symbol Quick Guide

-  10 — End time
-  11 — Cook time
-  12 — Minute minder
-  13 — Set time of day

i For best results when using the programmers touch controls - touch and then remove your fingertip quickly and lightly - unless the instruction states otherwise.
TIP: Make sure fingertips are cool and dry.

Using The Programmer / Clock

Please note: When using these instructions for the programmer, the numbers eg 1³ correspond to the symbol Quick Guide.

Setting the time of day on the Electronic Clock

- When you connect your oven, 12:00 (midday) and 1³ flash on the clock. Using "+" and "-" set the time on the clock. The quickest way is to use "-" for the morning hours and "+" for afternoon/ evening hours.
- The clock beeps twice to confirm the time selected.
- If you wish to change the time, touch the clock screen for a time until indicator 1³ illuminates. Touch until 1³ flashes.
- Then use "+" or "-" to modify the time. The clock beeps twice to confirm the modification. At all times symbol 1³ remains illuminated.

Programming the Minute minder

1. Repeatedly touch the display screen until symbol 1² lights up. The clock screen displays '00.00'.
2. Set the period of time after which you wish the alarm to sound by touching "+" or "-", this is in one minute increments.
3. The clock beeps twice, the current time is displayed and symbol 1² lights up permanently to indicate that the alarm has been set.
4. When the set period of time comes to an end, the alarm sounds and symbol 1² starts to flash.
5. Touch any main oven icon to silence the alarm.





To cancel:

1. Repeatedly touch the clock screen until symbol 1² lights up and the remaining time appears on the clock screen. Then use the "-" to reduce the remaining time to 00.00.
- You can consult the remaining time when required by repeatedly touching the clock screen until 1² flashes. You can also modify the set time at this point by touching "+" or "-". The clock beeps twice to confirm the change.
- If you wish to view the remaining time, repeatedly touch the clock screen until symbol 1² flashes.



Remember that the minute minder is a reminder only.

Symbol Quick Guide

-  10 — End time
-  11 — Cook time
-  12 — Minute minder
-  13 — Set time of day



Always keep the fascia panel clear of any cooking fats/greases as this may impair the touch control panel. The fascia panel may also require regular wiping with a soft cloth to prevent a build up of oils from your fingertips.



Maximum length of time the minute minder can be set for is:

**23 hours &
59 minutes**

Using The Programmer / Clock

Setting the Cook Time

1. Repeatedly touch the clock screen until symbol ¹¹ lights up. The clock screen displays '00.00'.
 2. Select the period of time you wish to cook for by touching and holding "+" or "-". This is in one minute increments.
 3. The clock beeps twice, the current time is displayed and symbol ¹¹ lights up permanently to indicate that the oven will turn itself off automatically.
 4. Select a cooking function and temperature - to set the oven function and temperature please refer to the **'Using Your Oven'** section. The clock will beep twice.
 5. When the cooking time comes to an end, the oven turns off, the alarm sounds and symbol ¹¹ flashes.
 6. Touch any main oven icon to silence the alarm.
 7. You can consult the remaining time when required by repeatedly touching the display screen until symbol ¹¹ flashes. You can also modify the set time at this point by touching "+" or "-". The clock beeps twice to confirm the change.
- If you wish the remaining time to be displayed until the end of the set period of time, repeatedly touch the clock screen until symbol ¹¹ flashes.
 - Then touch the clock screen again for a time. Symbol ¹¹ flashes more slowly.
 - Touch the clock screen again for a time in order to return to current time.



Important: Remove food as soon as it has cooked.

Symbol Quick Guide



10 — End time



11 — Cook time



12 — Minute minder



13 — Set time of day



For best results when using the programmers touch controls - touch and then remove your fingertip quickly and lightly - unless the instruction states otherwise.

Using The Programmer / Clock

Setting the End Time

1. Repeatedly touch the clock screen until symbol ¹⁰ lights up.
 2. The current time of day appears on the clock screen, this is adjusted by touching and holding the "+" symbol until you have the hour, and minutes past that you require. Using the "-" will also adjust the time if you go past the time you want.
 3. The clock beeps twice, the current time is displayed and symbol ¹⁰ lights up permanently to indicate that the oven will switch off automatically.
 4. Select a cooking function and temperature - to set the oven function and temperature please refer to the **'Using Your Oven'** section. The clock will beep twice.
 5. When the set time is reached, the oven turns off, the alarm sounds and symbol ¹⁰ flashes.
 6. Touch any main oven icon to silence the alarm.
- You can consult the finishing time when required by repeatedly touching the clock screen until symbol ¹⁰ flashes.
 - You can also modify it at this point by touching "+" or "-" the clock beeps twice to confirm the change.
 - This function can be used even when you are already using the oven. To do this, follow the instructions indicated above except point number 4.



Important: Remove food as soon as it has cooked.

Symbol Quick Guide



10 — End time



11 — Cook time



12 — Minute minder



13 — Set time of day







For best results when using the programmers touch controls - touch and then remove your fingertip quickly and lightly - unless the instruction states otherwise.

Using The Programmer / Clock

Setting the Automatic Programmer

1. Repeatedly touch the clock screen until symbol ¹¹ lights up.
 2. Select the period of time you wish to cook for by touching, and holding "+" or "-". This is adjusted in increments of one minute.
 3. The clock beeps twice, the current time is displayed and symbol ¹¹ lights up permanently.
 4. Repeatedly touch the clock screen again until symbol ¹⁰ lights up.
 5. The current time of day appears on the clock screen, this is adjusted by touching and holding the "+" symbol until you have the hour, and minutes past that you require. Using the "-" symbol will also adjust the time if you go past the time you want.
 6. The clock beeps twice, the current time is displayed and symbol ¹⁰ lights up permanently.
 7. Select a cooking function and temperature - to set the oven function and temperature please refer to the '**Using Your Oven**' section. The clock will beep and the oven lights will come on for a short time.
 8. The oven remains off with symbols ¹¹ and ¹⁰ lit up. Your oven is programmed. The oven light remains off.
 9. When the time to start cooking is reached, the oven starts up and cooks for the set period of time.
 10. When the set time is reached, the oven turns itself off, the alarm sounds and symbols ¹¹ and ¹⁰ flash.
 11. Touch any main oven icon to silence the alarm. Make sure that the appliance is switched off after using the Automatic Programmer.
Should you need extra time, switch the oven back on, and re-set the programmer if required.
- **To cancel** the Automatic Programmer, touch the 'Oven Off' symbol, and either re-program or switch the oven back on. Alternatively, touch the clock screen until symbol ¹¹ flashes, then use the "-" symbol to reduce to zero cancelling the timer function.
 - If you wish to modify the end cooking time when cooking is already in progress, touch the clock screen until ¹⁰ flashes.
 - You can then modify the end cooking time by touching "+" or "-". The clock beeps twice to confirm the change.

Symbol Quick Guide

-  10 — End time
-  11 — Cook time
-  12 — Minute minder
-  13 — Set time of day

i Always keep the fascia panel clear of any cooking fats/greases as this may impair the touch control panel. The fascia panel may also require regular wiping with a soft cloth to prevent a build up of oils from your fingertips.

Using The Programmer / Clock

When using the programmer

Do

- ✓ Familiarise yourself with the use of the programmer.
- ✓ Select foods that are as cold as possible, preferably straight from the fridge.
- ✓ Choose foods that are suitable for cooking from cold start, as the oven will not be pre-heated. Some foods will be affected by storage at room temperature for prolonged periods of time and may not cook properly.
- ✓ Make sure that all foods are thoroughly thawed especially meats.
- ✓ Cover dishes with lids or foil.
- ✓ Try to keep the end time as close to your return as possible.

Do not

- ✗ Place warm food in the oven for delayed start cooking. Foods should be thoroughly cooled before placing in the oven.
- ✗ Set up any automatic programmes while the oven cavity is warm i.e. straight after use. Always allow the oven to cool down first.
- ✗ Cook dishes containing poultry or left over meats. Also pies and pastries with wet fillings should also never be cooked using the automatic setting as they are not suitable.
- ✗ Over fill dishes containing liquids.

Before using your Automatic Programmer

It is a good idea to supervise cooking the first time you use the Automatic Programmer. Familiarising yourself with how the Programmer works can help to avoid under or over cooking food.

Using Your Oven - Defrosting Food

Defrosting Food:

Frozen food can be thawed out by using the 'Defrost' function (see using your oven-icons).

The defrost system on this appliance uses hot air circulated within the oven cavity, and has 2 power levels; LO & HI. LO is used for defrosting bread, cakes and fish while HI is used for all kinds of meat.

Using the Defrost

- Touch the Oven On icon. | | |
- Touch the Defrost icon. | * |
- HI will flash in the temperature display screen, and the oven lights will illuminate.
- The power levels can be selected by touching the temperature display and then touch the + or – keys to select either HI or LO settings.

Defrosting Guide

NOTE:

The above times are given as an indication only. Times may vary due to weight, time the item has been frozen & room temperature.

Food	LO level		HI level	
	Weight (lb)	Time (min)	Weight (lb)	Time (min)
Bread	1	35		
Cakes	1	25		
Fish	1	30		
Fish	2	40		
Chicken			2	75
Chicken			3	90
T-Bone Steak			1	40
Minced Meat			1	60
Minced Meat			2	120

SteamCleanse





About this function

In order to keep your appliance working properly it should be regularly cleaned to prevent any build up of food deposits or greases. This function can help to make the cleaning process easier and more convenient for you.

How it works

By using heat, steam and a few drops of washing up liquid food deposits are loosened and softened enough to make their removal much easier – eliminating the need to scrub the enamel. The  symbol is a special heat setting that is designed for this kind of cleaning.

How to use. .

- Remove all oven furniture before use.
- Pour 300ml approx. of water with a few drops of washing up liquid added onto a large absorbent sponge (recommended size: 360mm x 300mm x 6mm) which is placed on the base of the cavity. If the oven cavity base is heavily soiled, you may want to leave the solution to soak for a short while before switching on the  function.
- Close the oven door, and touch the Oven On icon .
- Select the SteamCleanse function by touching the icon  this will flash for approx. 3 minutes while the oven heats up to temperature.
- After 3 minutes the icon will remain illuminated (not flashing) - signalling that the SteamCleanse is in progress. The oven lights in the cavity will **not** be illuminated.
- The cleaning cycle is approximately 21 minutes long, and an alarm will sound once it is completed.
- Once cleaning is finished, make sure that the appliance is switched off - touch the Oven Off icon .
- Use the large absorbent sponge to remove any excess water from the base of the cavity.
- You can now clean the inside of the oven using a soft plastic bristled brush, cloth, sponge or other non abrasive implement and warm soapy water.
- Particularly stubborn soiling can be removed with a specialist scraper (i.e. ceramic glass scraper).
- Rinse the cavity thoroughly using plenty of clean water and a cloth. Then dry carefully throughout using a soft dry cloth. Make sure than you clean and dry all the inside, and the surround of the appliance – particularly the door seals.

Using Your Grill

Before you start grilling.

Before you use the grill, make sure you have placed the utensils in the position you need as once the grill is on you may injure yourself if you try to move the shelf.

- **Always close** the door while the grill is in use.

- Touch the Oven On icon | |

1. Touch the icon for the grill function. The pre-set heat setting will appear in the temperature display window.

2. The temperature indicator displays a set temperature for the cooking function selected. If you wish to modify this temperature, touch the temperature display screen until + and - flash. Then touch + or - to select the desired temperature.

While the grill is heating up, the '°' on the temperature display screen flashes to indicate that the oven is heating up.

- To switch off, touch the Oven off icon. | ○ |
- The single grill uses part of the element only, and is better suited to grill smaller amounts of food.
- The dual grill uses all of the element, and is better suited to grill larger amounts of food, and for toasting.

Aluminium Foil

Never cover the grill pan or grill trivet with foil, or allow fat to build up in the grill pan, as this can create a fire hazard.

Handle

When removing the tray(s) from under the grill, use the handle and make sure that your hands are protected - the area around the grill may be hot.

The handle supplied can be used with either the cake tray, or the roasting tray. Use with the long hook at the top (see picture A) when removing the roasting tray. Use with the short hook at the top (see picture B) when removing the cake tray.

i Warning: Accessible parts may become hot when the grill is in use. Children should be kept away.

i Types of grill

Single grill: has one grill element.

Dual grill: has two grill elements, which can be used together, or as a single grill.

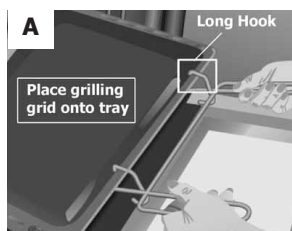

i Lowest temp - 50 °C
Highest temp - 250 °C

i Please note: the grill pan handle is designed for sliding the grill pan into and out of the grill cavity. It is not to be used to lift, or carry, the pan.



Using Your Oven

Switching on the multifunction oven

1. Touch Oven on. 
2. Touch the symbol for the desired cooking function.
3. The temperature indicator displays a set temperature for the cooking function selected. If you wish to modify this temperature, touch the temperature display screen until + and - flash. Then touch + or - to select the desired temperature.
4. The oven begins to heat up.
5. While the oven is heating up, the  on the temperature display screen flashes to indicate that the oven is heating up.
6. To turn the oven off, touch Oven off. 

Note

When the cooking process is over, the oven cooling system continues working until the interior of the oven reaches a suitable temperature.

Lock Function:

This function prevents interference with the oven controls during use by locking the oven. To activate;

- Press and hold the 'Oven Off'  icon for a short period of time.
- A long beep will be heard and flashing dots will appear in the meat sensor temperature display/screen. Your oven controls are now locked.

To deactivate this function:

- Press and hold the 'Oven Off'  icon for a short period of time.
- A long beep will be heard and the flashing dots will go out.

Your oven controls are now un-locked.



Never place food, or dishes on the base of the oven.



Always keep children away from the appliance while it is in use.



The clock must have the time of day set before use.



Lowest temp - 50 °C
Highest temp - 250 °C

Meat Sensor

Using the meat sensor

The meat sensor measures the temperature inside meat as it roasts. When this temperature reaches a set level, the oven turns itself off automatically.

Cooking with the meat sensor ensures optimum cooking results regardless of the type or weight of the meat being roasted.

Tips for using the sensor

- Insert the sensor into the meat before starting to cook.
- Insert the sensor in one side of the meat in such a way that the tip reaches the centre.
- When roasting meat should be turned halfway through the cooking process.
This should be remembered in order to prevent problems with the sensor.
- The tip of the sensor should not be in contact with bone, fat or hollow sections, as may be the case with poultry.
This will distort the temperature reading and the oven may switch off too soon.

How to use the meat sensor

1. Place the meat inside the oven with the meat sensor in position.
2. Plug the meat sensor fully into the socket located in the top left-hand corner of the oven.
3. When the sensor is connected, a set temperature (65°C) flashes on the meat sensor temperature display on the control panel.
4. Touch and hold the meat sensor temperature display screen until the "+" and "-" flashes, and then touch "+" and "-" if you wish to modify the recommended temperature.
5. Two beeps are then heard and the meat sensor temperature display will come on permanently.
6. The sensor temperature display shows the current temperature inside the meat.
7. Choose a cooking function and an oven temperature for the roast. Consult the cooking tables.
8. When the temperature inside the roast reaches the set temperature, the oven turns itself off and the alarm sounds for a short period of time.
9. Touch any main oven icon to silence the alarm. The meat is cooked and ready to be served.



Only use the original meat sensor supplied and make sure it is fully inserted into the socket.



If the meat sensor display shows **99°C** then the sensor needs to be pushed fully into the socket.



Always make sure that the sensor is inserted completely - up to the handle - into the meat.

Meat Sensor

Meat Sensor Guide

Food	Sensor Temperature °C	Comments
Roast Beef	35 - 40	Rare
Roast Beef	45 - 50	Medium
Roast Beef	55 - 60	Well done
Leg of Lamb	65 - 70	
Joint	80 - 85	
Loin of Pork	65 - 70	
Ham	80 - 85	
Chicken	75 - 80	
Roast Turkey	80 - 85	

Note: If required the temperatures given here may be adjusted using the "+" and "-" symbols on the fascia.

- Touch the meat probe indicator display screen until the "+" and "-" begin to flash.
- Adjust the temperature using the "+" and "-" .
Results depend on personal preferences and tastes.

Cooking Guide Notes

Using the Cooking Guides

Adjustments can be made to suit personal preferences and tastes.

























For best results we recommend that the oven is pre-heated before use. Pre-heating is finished when the temperature indicator goes out.

Fanned ovens are more efficient than conventional ovens. In some instances you may find that you need to reduce the temperature given in recipes by between 10°C and 20°C – if they are given as conventional oven temperatures. Alternatively, you can reduce the cooking time.

Always make sure the foods have been cooked thoroughly before consuming them and are piping hot in the centre. Never consume foods which are not completely cooked through.

























Always follow the manufacturer's instructions given when cooking convenience meals and packaged foods.

Cooking Guide – Starters





















Starters	Weight kg	Tray position	Function	Temp °C	Time (min)
Baked rice	0.35	1		180 - 200	45 - 50
		1	 	170 - 190	35 - 40
Pastry	1.5	3		170 - 190	45 - 50
		2	 	160 - 180	30 - 35
Vegetable pastry	1	2		190 - 210	35 - 40
		2	 	170 - 190	30 - 35
Vegetable pie	1	3		190 - 210	55 - 60
		3		170 - 190	45 - 50
		3		170 - 190	50 - 55
Baked Potatoes	1	3		180 - 200	60 - 65
		3	 	180 - 200	50 - 55
Pizza*	0.65	3		190 - 210	20 - 25
		2	 	170 - 190	15 - 20
Quiche	1.5	2		180 - 200	45 - 50
		2	 	160 - 180	45 - 50
Stuffed tomatoes	0.75	3		170 - 190	10 - 15
		2	 	160 - 180	10 - 15

* Or use the pizza function.













Cooking Guide - Fish

Fish	Weight kg	Tray position	Function	Temp °C	Time (min)
Red Bream	1.5	3		180 - 200	30 - 35
			 	170 - 190	25 - 30
Salted Dorado	1	3		190 - 200	25 - 30
			 	180 - 200	25 - 30
Fish pastry	1	2		190 - 210	30 - 35
			 	180 - 200	30 - 35
Sole	1	3		170 - 190	15 - 20
			 	160 - 180	10 - 15
Sea-Bass	1	3		190 - 210	20 - 25
			 	180 - 200	15 - 20
Hake	1.5	3		190 - 210	25 - 30
			 	180 - 200	20 - 25
Salmon (in greased paper)	1	3		180 - 200	20 - 25
			 	170 - 190	15 - 20
Trout	1	2		190 - 210	20 - 25
			 	180 - 200	15 - 20













Cooking Guide - Meats

Meats	Weight kg	Tray position	Function	Temp °C	Time (min)
Suckling pig	2	3		190 - 210	75 - 85
				170 - 190	65 - 75
				180 - 200	80 - 85
Lamb	1.5	3		190 - 210	50 - 55
				170 - 190	45 - 50
				180 - 200	50 - 55
Joint of meat	1.5	3		170 - 190	35 - 40
				160 - 180	30 - 35
				170 - 190	30 - 35
Salted pork loin	1	3		170 - 190	40 - 45
				160 - 180	30 - 35
				170 - 190	30 - 35
Chicken	1.5	3		190 - 210	50 - 55
			 	170 - 190	45 - 50
Roast Beef	1	3		190 - 210	35 - 40
				170 - 190	30 - 35
				180 - 200	35 - 40
Filet steak in pastry	1	3		180 - 200	35 - 40
			 	160 - 180	30 - 35

Cooking Guide - Sweets

Sweets	Weight kg	Tray position	Function	Temp °C	Time (min)
Sponge cake	0.5	2		170 - 190	35 - 40
				160 - 180	30 - 35
Swiss roll	0.3	3		170 - 190	10 - 15
				160 - 180	10 - 15
Flan	0.5	1		160 - 170	60 - 65
		2		160 - 170	55 - 60
Biscuits	0.5	3		160 - 180	20 - 25
				150 - 170	15 - 20
Vol-au-vents	0.25	3		170 - 190	15 - 20
				170 - 190	15 - 20
Cup cakes	0.5	2		160 - 180	25 - 30
				150 - 170	25 - 30

Cooking Guide - Sweets

Sweets	Weight kg	Tray position	Function	Temp °C	Time (min)
Baked apples	1	3		180 - 200	35 - 40
				170 - 190	30 - 35
Baked bananas	0.5	3		170 - 190	15 - 20
				170 - 190	15 - 20
Puff pastry biscuits	0.25	2		180 - 200	20 - 25
				170 - 190	20 - 25
Plum cake	0.5	2		170 - 190	60 - 65
				160 - 180	50 - 55
Apple pie	1	2		170 - 190	50 - 55
				160 - 180	45 - 50
Cheesecake	1	2		180 - 200	45 - 50
				170 - 190	35 - 40

Care and Cleaning

The inside of the oven should be cleaned to remove any deposits (food spillage etc) which can give off smoke or odours and cause stains to appear.



Caution
Before carrying out any work, the appliance must be disconnected from the electricity supply.

- Allow the oven to cool before cleaning
- For enamelled surfaces (e.g. the floor of the oven) use a nylon brush or sponge with warm soapy water. If using specialist oven cleaning products, use only on enamelled surfaces and follow the manufacturer's instructions.
- Clean the outside of the oven and the accessories with warm soapy water or with a mild detergent.
- When cleaning stainless steel parts, use soft cloths or sponges to avoid scratching the stainless steel. If using stainless steel cleaners, always follow the instructions on the packaging.

Cautions

- ✗ **Do not** clean the inside of your oven with a steam cleaners or pressurised water.
- ✗ **Do not** use either metallic scouring pads or any material that could scratch the appliance.
- ✗ For your own safety, **never** switch the oven on without the back panel that protects the fan.
- ✗ **Do not** remove the control knobs when cleaning the outside of the oven.

Instructions for Removing the Supports and the Back Panel.

- Remove the accessories from inside the oven.
- Ease out the supports (D), releasing them from the bolt (E)
- To disassemble the back panel, remove screw (F).
- Reassemble in reverse order.

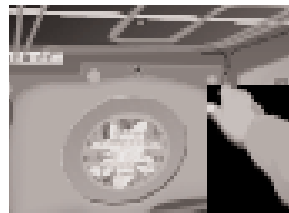
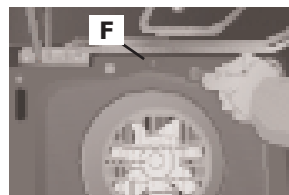
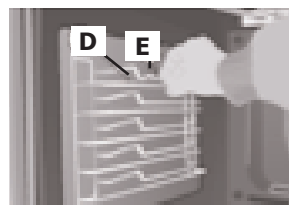

Care and Cleaning

Cleaning the Oven Door

To remove the inner door glass:

- Open the door fully.
- Pull the glass towards you from the bottom (A).
- The Inner door glass can now be removed.

To reassemble the inner door glass:

- Holding the inner door glass with the chamfer in the bottom right hand corner
- Insert the metal clips in the cut outs at the top of the inner door panel (B).
- Lower the glass into the door (C).
- The glass is fixed to the door by pressing the two lower supports (D) while pushing the glass into the door (E).

- **Warning:** Should the inner door glass become damaged, cracked or chipped it must be replaced. Even small chips or cracks in the glass can cause it to shatter suddenly when heated.
- Abrasive cleaning agents and metallic cleaning implements can cause scratches in the glass, and therefore should be avoided.
- For best results use warm soapy water, mild detergents and a soft cloth.
- Always dry the door glass carefully before replacing it.



Warning:
Take care when removing the inner door glass as once removed the oven door will return to the closed position.



Care and Cleaning

We also sell cleaning products which are available from the Spares Sales team



To order or enquire about any of these products, please call the Spares Sales team on: 0870 458 9961

Product description	Product code	Qty	Where used
Rectangular carbon filters	082612620	2	Hoods
Round carbon filters	082611571	1	Hoods
Ceramic hob scraper kit	082606781	1	All ceramic glass hobs, including induction
Ceramic hob cleaner and conditioner	082606780	1	All ceramic glass hobs, including induction
Sealed hotplate cleaner	082606783	1	All sealed / solid plate hobs
Stainless steel cleaner	082606764	1	All stainless steel parts
Oven cleaner spray	082606786	1	All cookers, inside cavities and on glass
Multi-purpose kitchen cleaner	082606782	1	General kitchen cleaner
E-Cloth	082813300	1	All cookers, for cleaning glass and stainless steel

Maintenance

Caution

Before carrying out any work, the appliance **must** be disconnected from the electricity supply.

Changing the oven bulb

- Ease out the telescopic guides, releasing them from the bolt (A).
 - Loosen the lens from the lamp holder with the help of an appropriate tool.
 - Replace the old bulb.
 - Replace the lens, making sure it fits in the correct position without forcing it.
-
- The replacement bulb must be temperature resistant to **300 °C**.
These can be ordered from our Customer Care Centre or be purchased from your local hardware store.
Please take the old bulb with you for reference.

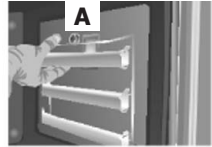

Troubleshooting

The oven does not work

- Check the connection to the electrical circuit.
- Check the fuses and current limiter of your installation.
- Ensure the clock is in the manual or programmed mode.
- Check the position of the function and temperature control knobs.

The inside light of the oven does not work

- Change the bulb.
- Check that the bulb has been replaced in accordance with the instruction manual.

The heating indicator light does not work

- Select a temperature.
- Select a setting.

There is smoke inside the oven during use

- This is normal during its first use.
- Periodically clean the oven.
- Reduce the amount of any grease or oil in the tray.
- Do not use higher temperature settings than those in the cooking tables, or recipe.

Expected cooking results are not achieved

- Check the cooking tables for further guidance about your oven.
- Check the recipe that you have been using, and the function. Fan ovens cook more efficiently than conventional ovens – so adjustment to time and temperature may be required.

If, despite these recommendations, the problem continues, contact our Customer Care Centre.



The Customer Care Centre can be contacted on:

0871 22 22 502

Please get in touch if you experience any problems not covered here.

Installation - Notes

Installation

This information is intended for the installer, as the person responsible for assembly and electrical connection. If you install the oven yourself, the manufacturer will not be held responsible for any possible damage.

Before Installation.

- An aperture is required in the kitchen unit to a minimum depth of 560mm.
- To fit the oven into this location, the back part of the unit must be clear of projections (reinforcements, pipes, sockets etc.)

Always ensure that this appliance is connected by a competent electrical installer who is a member of a recognised 'competent persons' scheme and who will comply with the I.E.E. and local regulations.

Before you start

- Always make sure that you have carefully read through the installation pages of this book - careful planning at the beginning will ensure a quick and easy installation.
- Take care when moving this appliance, it may be heavier than it looks! If you need to lift the appliance, make sure you use an appropriate lifting method.
- Soft, or uneven flooring may be damaged unless the appliance is moved with care.
- DO NOT attempt to move the oven by pulling on the handles or doors, we recommend that you open the door and grasp the frame of the cooker. Please wear protective gloves for this, and make sure the door cannot trap your fingers.

Please make sure that you have enough space for your appliance, use the table and diagrams shown to help determine this.



After connecting the electricity, check that all the electrical parts of the oven are working.



Installation must only be performed by a fully qualified electrician who must ensure regulations in force for installation are observed.



Warning:
This appliance must be earthed

Installation – Diagrams

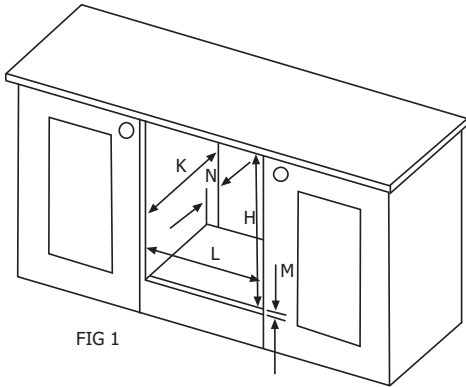

FIG 1

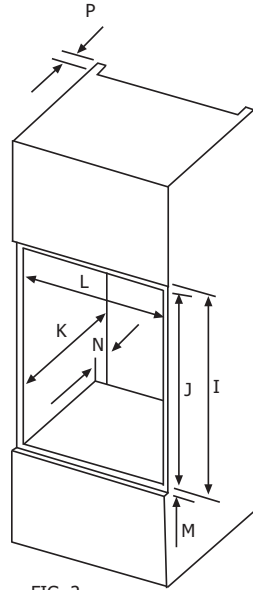

FIG 2

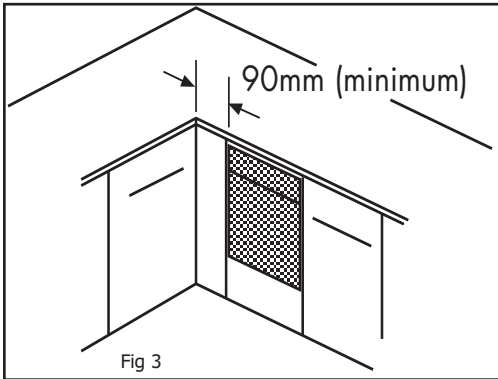

Fig 3

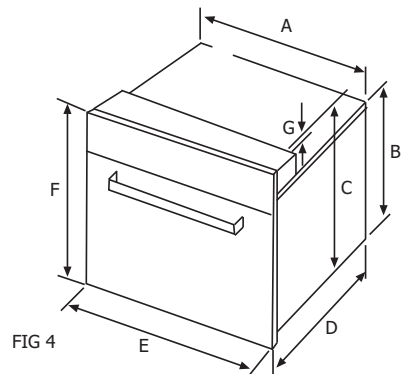

FIG 4

Product	Dimension (mm)														
	A	B	C	D	E	F	G	H	I	J	K	L	M	N	P
600mm	557.0	483.0	564.0	540.0	595.0	595.0	31.0	600.0	600.0	590.0	min 560	558 - 568	min 10	min 30	60 - 100

Installation – 600mm

- Leave the appliance in the base tray packaging until you are ready to install it. When you remove the appliance from the base tray packaging, take care not to damage it.
- Whilst every care is taken to eliminate burrs and raw edges from this product, please take care when handling - we recommend the use of protective gloves during installation.
- Please note that all dimensions and sizes given are nominal, some variation is to be expected.
- If this appliance is to be installed near to a corner where the adjacent cabinets run at right angles forward of the appliance, there must be a gap of at least 90mm between the appliance and the cabinets, to prevent overheating of the cabinets (FIG 3).

Important:

- **Do not** modify the outer panels of this appliance in any way.

Fixing screws.

The fixing screws are in a polythene bag in the oven pack.

Depending on the method of installation, some of the screws may not be needed.

If you have a non standard size of cabinet which leaves a gap above or below the appliance, you may be able to buy a trim kit (to fill in the gap) from the supplier of your cabinets.

Installation – Into Oven Housing Unit

Refer to FIG.2 for the dimensional requirements.

Remove the fixing screws from the polythene bag, but leave the appliance in the base tray packaging until you are ready to install it.

Note: When removing the appliance from the base tray packaging care should be taken not to damage the appliance, follow lifting instructions in the "Before you start" section.

1. When installing in a typical built in oven housing unit, the false back should be removed from the housing unit to provide the necessary depth for installation.
2. When the false back is removed, it is normally the case that the support shelf for the appliance leaves a gap between the back edge and the wall of approximately 80mm.
3. If no gap occurs between the back edge of the shelf and the wall behind the unit, a minimum gap of 30mm should be created by shortening the shelf, this is to provide adequate ventilation for the product.
4. Ventilation is required for the product, to allow it to function correctly, a cutout should cut into the top of the housing unit (see FIG.2), to provide this.
5. Slide the appliance into position and secure to the cabinet using the screws provided.

The appliance is designed to fit into a standard 600mm wide housing unit, with minimum internal dimensions as shown in FIG.2 of the installation dimensions.

Please note that all sizes are nominal, and some variation is to be expected.

Installation – Under A Worktop

Refer to FIG.1 for the dimensional requirements.

Where the appliance is installed under a worktop, with a hob installed above it, the installation instructions for the hob must be read in conjunction with these instructions.

When installing a gas hob above the appliance, care must be taken to ensure the hob inlet pipe is as close to the back wall as possible, so it doesn't obstruct the oven.

If a flexible hose is used care must be taken not to trap it between the oven and the wall.

If the hob protrudes below the worktop you may have to lower the oven to compensate.

Remove the fixing screws from the polythene bag, but leave the appliance in the base tray packaging until you are ready to install it.

Note: When removing the appliance from the base tray packaging care should be taken not to damage the appliance, follow lifting instructions in the "Before you start" section.

1. When installing in a typical built under oven housing unit, the false back should be removed from the housing unit to provide the necessary depth for installation.
2. When the false back is removed, it is normally the case that the support shelf for the appliance leaves a gap between the back edge and the wall of approximately 80mm.
3. If no gap occurs between the back edge of the shelf and the wall behind the unit, a minimum gap of 30mm should be created by shortening the shelf, this is to provide adequate ventilation for the product.
4. Slide the appliance into position and secure to the cabinet using the screws provided.

The appliance is designed to fit into a standard 600mm wide housing unit, with minimum internal dimensions as shown in FIG.1 of the installation dimensions.

Please note that all sizes are nominal, and some variation is to be expected.

Installation – Electricity Notes

Electrical Connection - Legal Requirements.

IMPORTANT:

We recommend that the appliance is connected by a qualified electrician, who is a member of the N.I.C.E.I.C. and who will comply with the I.E.E. and local regulations.

Important: Ensure that you route all mains electrical cables well clear of any adjacent heat source, such as an oven or grill.

Warning: This appliance must be earthed.

- Where a fixed connection is used, a device allowing the appliance to be isolated on all poles from the mains supply with a contact opening width of at least 3mm must be provided.
- The mains terminal block is positioned at the right hand rear of the top service panel.
- Connect the cable to the terminal block, and tighten the cable clamp.
- Close the terminal box, ensuring that the cover is engaged on the locking tabs.

After connection to the electricity supply please check that all electrical parts of the appliance are working.

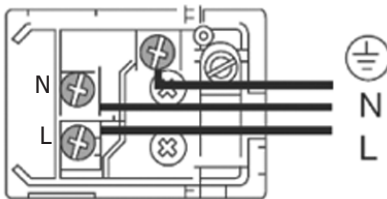

3 x 1,5mm²

Technical Data

Technical Information

If the equipment does not work, please contact the Technical Service Department and advise them of the problem, indicating:

- Serial number (S-No)
- Appliance model. (Model)

You will find this information on the rating plate on the lower part of the oven when the door is opened. There is a space provided to record this at the back of this handbook.

The item that you have bought meets the European directives on electrical material safety (73/23/CEE) and electromagnetic compatibility (89/336/CEE).

Technical Data

@ 230v		
		S7 - E600MF
Main cavity		
	Fanned oven	2000 W
	Multifunction oven	3150W
Extras		
	Lights	50 W
	Fan	30 W
	Cooling fan	18 W
Total wattage		3248 W

Electrical rating: 220 – 240v ~ 50Hz/60Hz

Countries of Destination: GB (Great Britain) IE (Ireland).

Always make sure that any old appliances have been disposed of correctly – you should never attempt to dispose of any large appliance with household waste. Instead, please contact your local council / authority for information regarding the collection or re-cycling of such products.

Do not attempt to make any functional repairs on this appliance yourself, unless you are informed that you can either within this handbook, or by a qualified service engineer. If in doubt, please call the Customer Care Centre.

Service Record

Date of purchase	Installer stamp / Printed name	Date of installation
Place of purchase:		

Date	Part(s) replaced	Engineers Stamp/ Printed Name

Contact Us

Should you need to contact us, please call our Customer Care Centre on:

0871 22 22 502.

Calls will be answered in strict rotation, as soon as possible.

Model Number										
Serial Number										

Please record your model and serial number in the spaces above.
Having these numbers to hand will help us to help you quickly and more efficiently
should you need to call us for any reason.

STOVES

Stoves

Stoney Lane, Prescot, Merseyside, L35 2XW

03.2008 / 08 26280 02
3172194 - 00