

*Accolade*<sup>™</sup>

S1 - E600F

600mm Built In Electric Fanned Oven & Grill

# Contents

---

About your Appliance	3
Before Use	4
Using your Oven – Icons	6
Using the Clock / Programmer	7
Using your Grill	11
Using your Oven	12
Cooking Guide – Notes	13
Cooking Guides:	
• Starters	14
• Fish	15
• Meats	16
• Sweets	17
Care and Cleaning	18
Maintenance	21
Troubleshooting	22
Installation	23
Technical Data	29
Service record	31

# About your Appliance: S1 - E600F

## Fascia layout

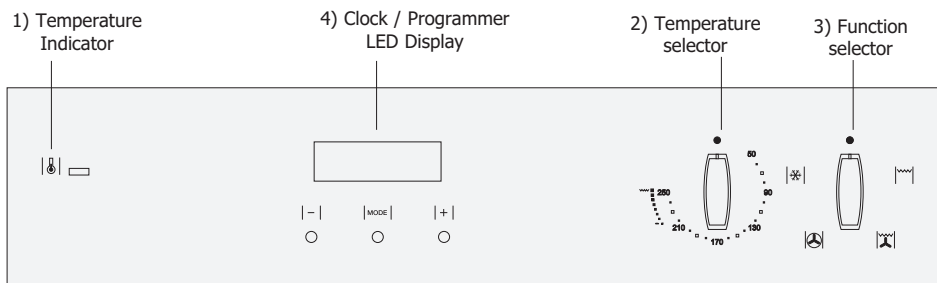



What is it?	What does it do?
1) The temperature indicator	Illuminates when the oven has reached the selected temperature, signalling that pre-heating is completed.
2) The temperature selector	Turn clockwise to set the temperature required in °C.
3) The function selector	Turn to select the function which best suits the food you are cooking.
Use the function selector and the temperature selector together to switch the oven off and on.	
4) The clock / programmer LED display	The display shows the current time of day. The Minute Minder or Automatic Programmer shows the remaining time when selected.

# Before Use

---

Carefully read this Instruction Manual before use to get the best results from your oven.

Before using the appliance for the first time, we recommend that you follow the instructions below:

- Remove all the packaging material, including the protective plastic, if included.
- Select the  or  function at 200 °C for one hour.
- Allow the oven to cool.
- The appliance and any furniture included should be thoroughly cleaned before use to remove any oils or residue left behind by the manufacturing process.
- During the first use, fumes and odours may occur and the kitchen should therefore be well ventilated.

## Ecological Packaging

The packaging materials are completely recyclable and can be used again. Check with your local authority on the regulations for disposing of this material.

## Disposing of old appliances

The symbol  on the product or on its packaging indicates that this product may not be treated as household waste, and should be disposed of carefully. By ensuring this product is disposed of correctly, you will help to prevent damage to the environment and human health, which could be caused by inappropriate waste handling.

Please make arrangements for the product to be transported to your local recycling centre.

Your local council, household waste disposal service or the retailer you purchased this appliance from can supply you with information about recycling facilities in your area.

# Before Use

---

## Electrical Safety

- Any repairs must be carried out by an authorised Service Engineer, using original spare parts. Failure to do so may invalidate any warranty, as well as cause damage to your appliance.
- Unplug your oven if it breaks down, and do not use it until a Service Engineer visit has taken place, or you have been advised that it is safe by a Customer Care Advisor.

## Safety Notes

- The oven **MUST NOT** be operated with the door open.
- The appliance is not intended for use by young children or infirm persons without supervision.
- This appliance is to be used for **domestic cooking purposes** only.
- Only use the oven when it is installed within kitchen units.
- Do not use the oven as a storage space - it could be dangerous if the oven is switched on.
- Do not lean, sit or place food on the open door of the oven.
- Do not cover the bottom of the oven with aluminium foil.
- Always use the side guides to support the oven trays and racks when the oven is in use.
- Do not put containers or food on the floor of the oven. Always use the trays and grids.
- While using the oven, open the door as little as possible to maintain the temperature inside.
- When moving or removing hot dishes, make sure you wear protective oven gloves.
- It is not unusual for condensation to form on the door while the oven is in use - this is most common with foods which have a high moisture content.



Parts of the appliance become hot while in use. Always make sure that children are supervised when they are near to the appliance.







Call Customer Care for a service engineer's visit if:

- You find over a period of time that the oven becomes hotter at a particular temperature - the thermostat may need replacing.
- The cooling fan fails to work.



Tip: Use the Minute Minder when cooking.

## Using Your Oven – Icons

Icon	What it is
	<b>Variable grill</b> Used for grilling food.
	<b>Grill + fan</b> Used for grilling foods. The fan circulates the heat quickly around the food – and eliminates the need for turning on foods such as bacon which a thinly sliced.
	<b>Fanned oven</b> Used for general cooking purposes. Provides an even heat throughout the oven, which is useful for batch baking. You may find that you need to reduce the temperature setting for recipes, or reduce the cooking time as this is a very efficient heat setting.
	<b>Defrost</b> Uses the fan only (no heat). Ideal for defrosting frozen deserts and joints of meat.



When using the fanned oven function for cooking, we recommend either reducing the temperature setting by around 10°C, or reduce the recipe time by around 10 minutes – however, please bear in mind that all cooking results are based on personal preference and taste.

### CAUTION:

When using ANY of the grill functions the door **MUST** remain closed.

# Using The Clock / Programmer

Through your programmer you will be able to set the time of day, the minute minder, and use the semi and fully automatic cooking functions. The programmer is vital to the working of your appliance, and reading this section will make sure that you get the most out of your oven(s).

## The programmer buttons

The table below shows you what the symbols look like and what they do.

Symbol	What is it?
-	Down / Minus Used to decrease cook / end time, remove minutes from the minute minder and adjust the time of day. Also used for selecting an alarm tone.
+	Up / Plus Used to increase the cook / end time, add minutes to the minute minder and adjust the time of day.
MODE	Mode button Used to select the functions available on the programmer. <ul style="list-style-type: none"> <li>● Press once for minute minder.</li> <li>● Press twice for cook time.</li> <li>● Press three times for end time.</li> </ul> How to use these functions is explained later in this section.

**i** What your timer symbols mean

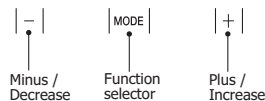

**i** This is a 24 hour clock. Before you use your appliance for the first time, you must ensure that the time of day is set.

## Setting the time of day

- Press 'plus' and 'minus' buttons together for a few seconds and then release.
- The '●' in between the numbers on the LED display will begin to flash.
- While the '●' is flashing, it is possible to adjust the time of day using the plus and minus buttons.
- Once the time has been set, allow approximately 30 seconds before using any of the other timer functions. This will ensure that the time of day remains correct.

## Changing the alarm tone

- Press 'plus' and 'minus' simultaneously. The '●' in the centre of the display will flash.
- Press 'mode' to display the text "ton" then press 'minus' button repeatedly to change the alarm tone.

# Using The Programmer / Clock

## Setting the minute minder

- To set the minute minder, press the mode button once. The bell symbol will appear and start flashing. The flashing only lasts for 5 seconds, so the minute minder must be set within this time.
- Use the plus and minus buttons to set the length of time required. Once this has been done, the minute minder is set.
- When the selected length of time has counted down an alarm will sound. To cancel the tone, press any of the timer buttons.
- Should you need to cancel the minute minder at any time during use, press the mode button once, and then press the plus and minus buttons together.

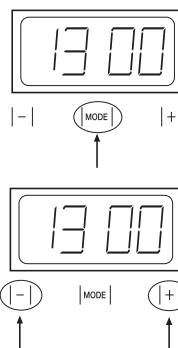

## Semi – automatic cooking methods

The duration method.

(Switch off after a set time period)

- Press the mode button twice, which will skip past the minute minder.
- The display will flash the word `dur` and 'A' for Auto will flash on the left hand side of the display.
- Use the plus and minus buttons to set the length of time you want to cook for. This must be done within 5 seconds – or the time of day will show again.
- Once this is done the oven will switch off when the cooking time has elapsed, and an alarm will sound. To switch off the alarm press any button.
- To view any remaining time, press the mode button twice.

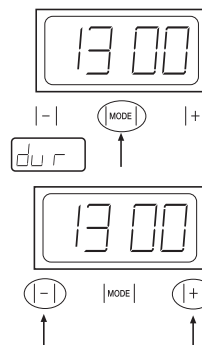

The end time method

(Switch off at a set end time)

- Press the mode button three times, which will skip past the minute minder and the duration method.
- The display will flash `End` and 'A' for Auto will flash on the left hand side of the display.
- Use the plus and minus buttons to select the time the oven is required to turn off.
- Once this is done the oven will switch off at the time you have selected. To switch off the alarm, press any button.
- To disarm the timer touch 'plus' and 'minus' together for a short period.

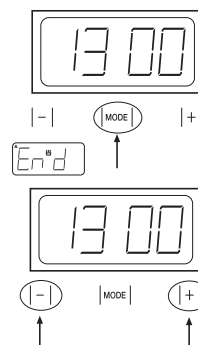





# Using The Programmer / Clock

## Fully automatic cooking

Switch on and off automatically

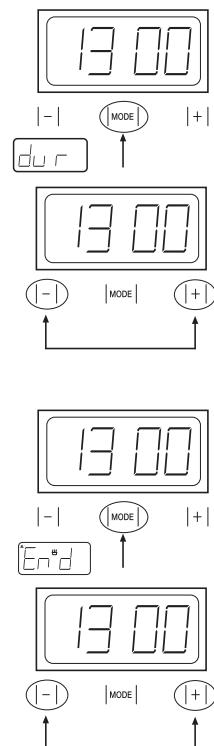
- This requires both the duration and the end time to be entered. The timer will work out the start time and begin cooking.
- Press the mode button twice, which will skip past the minute minder.
- The display will flash the word `dur` and 'A' for Auto will flash on the left hand side of the display.
- Use the plus and minus buttons to set the length of time you want to cook for. This must be done within 5 seconds, or the time of day will show again.
- Press the mode button three times, which will skip past the minute minder and the duration programmer.
- The display will flash `En°d` and 'A' for Auto will flash on the left hand side of the display.
- Use the plus and minus buttons to set the time you require the oven to switch **off** at.
- Once this is done, the oven will be set to switch off at the time you have selected.
- Set the oven to the temperature, switch on the oven and place your food inside. The oven light will not be illuminated at this point.
- The timer will then calculate the start time from the information you have programmed. The oven lights inside the cavity will switch on indicating that cooking has begun.
- Once cooking is completed, an alarm will sound and the oven will switch off. To cancel the alarm tone, press any button.
- To cancel any of the semi and full automatic functions at any time, press the plus and minus buttons together.



 The automatic cooking symbol "A" will appear to show that the oven is no longer in manual mode, but in automatic mode..

 Important: Once the oven has switched off – return the oven controls to the 'off' position.

 Important: Remove food as soon as it has cooked.

# Using The Programmer / Clock

---

## **When using the programmer**

### **Do**

- ✓ Familiarise yourself with the use of the programmer.
- ✓ Select foods that are as cold as possible, preferably straight from the fridge.
- ✓ Choose foods that are suitable for cooking from cold start, as the oven will not be pre-heated. Some foods will be affected by storage at room temperature for prolonged periods of time and may not cook properly.
- ✓ Make sure that all foods are thoroughly thawed especially meats.
- ✓ Cover dishes with lids or foil.
- ✓ Try to keep the end time as close to your return as possible.

### **Do not**

- ✗ Place warm food in the oven for delayed start cooking. Foods should be thoroughly cooled before placing in the oven.
- ✗ Set up any automatic programmes while the oven cavity is warm i.e. straight after use. Always allow the oven to cool down first.
- ✗ Cook dishes containing poultry or left over meats. Also pies and pastries with wet fillings should also never be cooked using the automatic setting as they are not suitable.
- ✗ Over fill dishes containing liquids.

## **Before using your Automatic Programmer**

It is a good idea to supervise cooking the first time you use the Automatic Programmer. Familiarising yourself with how the Programmer works can help to avoid under or over cooking food.

# Using Your Grill

## Before you start grilling.

Before you use the grill, make sure you have placed the utensils in the position you need as once the grill is on you may injure yourself if you try to move the shelf.

- **Close the door** while the grill is in use.
  1. Turn the selector control knob to the grill function. (The selector knob may be turned either clockwise, or anticlockwise)
  2. Turn the thermostat control knob to the heat setting you require, as this is a variable grill you can adjust the heat to suit the kind of food you are cooking. (The temperature knob may only be turned clockwise)
- To switch off, return the control knob to the 'off' position.

## Aluminium Foil

Never cover the grill pan or grid with foil, or allow fat to build up in the grill pan, as this can create a fire hazard.

## Handle

When removing the tray(s) from under the grill, use the handle and make sure that your hands are protected - the area around the grill may be hot.

The handle supplied can be used with either the cake tray, or the roasting tray. Use with the long hook at the top (see picture A) when removing the roasting tray. Use with the short hook at the top (see picture B) when removing the cake tray.

**i** Warning: Accessible parts may become hot when the grill is in use. Children should be kept away.

**i** For best results: Pre-heat the grill for about 3 minutes.

**i** Please note: the grill pan handle is designed for sliding the grill pan into and out of the grill cavity. It is not to be used to lift, or carry, the pan.

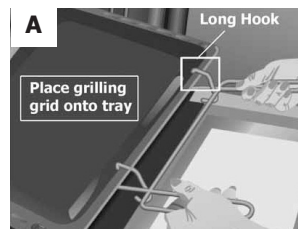

# Using Your Oven

---

## Switching on the oven

- Use the function control knob to select the function you wish to use - see the functions table for details. (The selector knob may be turned either clockwise, or anticlockwise)
- **Note:** You can change function during cooking if you wish, as long as the oven is in manual mode.
- Turn the temperature control knob to adjust the temperature to suit your requirements if needed. (The temperature knob may only be turned clockwise)
- You must select both a function and a temperature in order to switch the oven on. The oven lights will switch on, and the oven will begin to heat.
- The thermostat indicator will come on to show that the oven is heating, and once the temperature is achieved, it will go out. The indicator will cycle on and off as the thermostat regulates the temperature inside.
- To switch off the main oven, simply turn all controls to the 'off' position.



Never place food, or dishes on the base of the oven.



Always keep children away from the appliance while it is in use.



The clock must have the time of day set before use.

# Cooking Guide Notes

---

## **Using the Cooking Guides**

Adjustments can be made to suit personal preferences and tastes.









For best results we recommend that the oven is pre-heated before use. Pre-heating is finished when the temperature indicator goes out.

Fanned ovens are more efficient than conventional ovens. In some instances you may find that you need to reduce the temperature given in recipes by between 10°C and 20°C – if they are given as conventional oven temperatures. Alternatively, you can reduce the cooking time.

Always make sure the foods have been cooked thoroughly before consuming them and are piping hot in the centre. Never consume foods which are not thoroughly cooked.

Always follow the manufacturer's instructions given when cooking convenience meals and packaged foods.







## Cooking Guide – Starters

<b>Starters</b>	<b>Weight kg</b>	<b>Tray position</b>	<b>Function</b>	<b>Temp °C</b>	<b>Time (min)</b>
<b>Baked rice</b>	0.35	1		170 - 190	35 - 40
<b>Pastry</b>	1.5	2		160 - 180	30 - 35
<b>Vegetable pastry</b>	1	2		170 - 190	30 - 35
<b>Vegetable pie</b>	1	2		170 - 190	50 - 55
<b>Baked Potatoes</b>	1	3		180 - 200	50 - 55
<b>Pizza</b>	0.65	2		170 - 190	15 - 20
<b>Quiche</b>	1.5	2		160 - 180	45 - 50
<b>Stuffed tomatoes</b>	0.75	2		160 - 180	10 - 15

## Cooking Guide - Fish













<b>Fish</b>	<b>Weight kg</b>	<b>Tray position</b>	<b>Function</b>	<b>Temp °C</b>	<b>Time (min)</b>
<b>Red Bream</b>	1.5	3		170 - 190	25 - 30
<b>Salted Dorado</b>	1	3		180 - 200	25 - 30
<b>Fish pastry</b>	1	2		180 - 200	30 - 35
<b>Sole</b>	1	3		160 - 180	10 - 15
<b>Sea-Bass</b>	1	3		180 - 200	15 - 20
<b>Hake</b>	1.5	3		180 - 200	20 - 25
<b>Salmon (in greased paper)</b>	1	3		170 - 190	15 - 20
<b>Trout</b>	1	2		180 - 200	15 - 20

## Cooking Guide - Meats

Meats	Weight kg	Tray position	Function	Temp °C	Time (min)
<b>Suckling pig</b>	2	3		180 - 200	80 - 85
<b>Lamb</b>	1.5	3		180 - 200	50 - 55
<b>Joint of meat</b>	1.5	3		170 - 190	30 - 35
<b>Salted pork loin</b>	1	3		170 - 190	30 - 35
<b>Chicken</b>	1.5	3		170 - 190	45 - 50
<b>Roast Beef</b>	1	3		180 - 200	35 - 40
<b>Filet steak in pastry</b>	1	3		160 - 180	30 - 35



## Cooking Guide - Sweets

Sweets	Weight kg	Tray position	Function	Temp °C	Time (min)
<b>Sponge cake</b>	0.5	2		160 - 180	30 - 35
<b>Swiss roll</b>	0.3	3		160 - 180	10 - 15
<b>Flan</b>	0.5	2		160 - 170	55 - 60
<b>Biscuits</b>	0.5	3		150 - 170	15 - 20
<b>Vol-au-vents</b>	0.25	3		170 - 180	15 - 20
<b>Cup cakes</b>	0.5	2		150 - 170	25 - 30
<b>Bakes apples</b>	1	3		170 - 190	30 - 35
<b>Baked bananas</b>	0.5	3		170 - 190	10 - 15
<b>Puff pastry biscuits</b>	0.25	2		170 - 190	20 - 25
<b>Plum cake</b>	0.5	2		160 - 180	50 - 55
<b>Apple pie</b>	1	2		160 - 180	45 - 50
<b>Cheesecake</b>	1	2		170 - 190	35 - 40

# Care and Cleaning

The inside of the oven should be cleaned to remove any deposits (food spillage etc) which can give off smoke or odours and cause stains to appear.



Caution  
Before carrying out any work, the appliance must be disconnected from the electricity supply.

- Allow the oven to cool before cleaning
- For enamelled surfaces (e.g. the floor of the oven) use a nylon brush or sponge with warm soapy water. If using specialist oven cleaning products, use only on enamelled surfaces and follow the manufacturer's instructions.
- Clean the outside of the oven and the accessories with warm soapy water or with a mild detergent.
- When cleaning stainless steel parts, use soft cloths or sponges to avoid scratching the stainless steel. If using stainless steel cleaners, always follow the instructions on the packaging.

## Cautions

- ✗ **Do not** clean the inside of your oven with a steam cleaners or pressurised water.
- ✗ **Do not** use either metallic scouring pads or any material that could scratch the appliance.
- ✗ For your own safety, **never** switch the oven on without the back panel that covers the fan.
- ✗ **Do not** remove the control knobs when cleaning the outside of the oven.

## Instructions for Removing the Supports and the Back Panel.

- Remove the accessories from inside the oven.
- Ease out the supports (D), releasing them from the bolt (E)
- To disassemble the back panel, remove screw (F).
- Reassemble in reverse order.

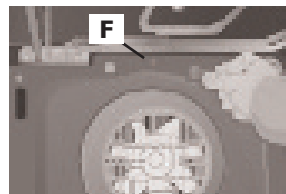
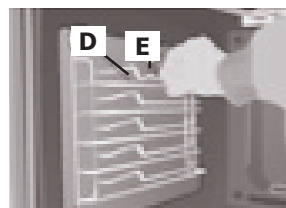

# Care and Cleaning

## Cleaning the Oven Door

To remove the inner door glass:

- Open the door fully.
- Pull the glass towards you from the bottom (A).
- The Inner door glass can now be removed.

To reassemble the inner door glass:

- Holding the inner door glass with the chamfer in the bottom right hand corner
- Insert the metal clips in the cut outs at the top of the inner door panel (B).
- Lower the glass into the door (C).
- The glass is fixed to the door by pressing the two lower supports (D) while pushing the glass into the door (E).

- **Warning:** Should the inner door glass become damaged, cracked or chipped it must be replaced. Even small chips or cracks in the glass can cause it to shatter suddenly when heated.
- Abrasive cleaning agents and metallic cleaning implements can cause scratches in the glass, and therefore should be avoided.
- For best results use warm soapy water, mild detergents and a soft cloth.
- Always dry the door glass carefully before replacing it.



**Warning:**  
Take care when removing the inner door glass as once removed the oven door will return to the closed position.

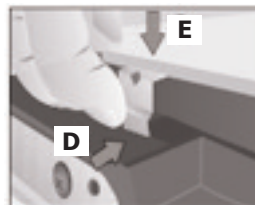

# Care and Cleaning

We also sell cleaning products which are available from the Spares Sales team

**i** To order or enquire about any of these products, please call the Spares Sales team on: 0870 458 9961

<b>Product description</b>	<b>Product code</b>	<b>Qty</b>	<b>Where used</b>
<b>Rectangular carbon filters</b>	082612620	2	Hoods
<b>Round carbon filters</b>	082611571	1	Hoods
<b>Ceramic hob scraper kit</b>	082606781	1	All ceramic glass hoes, including induction
<b>Ceramic hob cleaner and conditioner</b>	082606780	1	All ceramic glass hoes, including induction
<b>Sealed hotplate cleaner</b>	082606783	1	All sealed / solid plate hoes
<b>Stainless steel cleaner</b>	082606764	1	All stainless steel parts
<b>Oven cleaner spray</b>	082606786	1	All cookers, inside cavities and on glass
<b>Multi-purpose kitchen cleaner</b>	082606782	1	General kitchen cleaner
<b>E-Cloth</b>	082813300	1	All cookers, for cleaning glass and stainless steel

# Maintenance

---

## Caution

Before carrying out any work, the appliance **must** be disconnected from the electricity supply.

## Changing the Oven Bulb

- Unscrew the lens from the lamp holder.
- Exchange the bulb and replace the lens.
- The replacement bulb must be temperature resistant to **300 °C**.  
These can be ordered from our Customer Care Centre or be purchased from your local hardware store. Please take the old bulb with you for reference.



# Troubleshooting

---

## **The oven does not work**

- Check the connection to the electrical circuit.
- Check the fuses and current limiter of your installation.
- Ensure the clock is in the manual or programmed mode.
- Check the position of the function and temperature control knobs.

## **The inside light of the oven does not work**

- Change the bulb.
- Check that the bulb has been replaced in accordance with the instruction manual.

## **The heating indicator light does not work**

- Select a temperature.
- Select a setting.

## **Smoke is given off while the oven is working**

- This is normal during its first use.
- Periodically clean the oven.
- Reduce the amount of grease or oil in the tray.
- Do not use higher temperature settings than those in the cooking tables, or recipe.

## **Expected cooking results are not achieved**

- Check the cooking tables for further guidance about your oven.
- Check the recipe that you have been using, and the function. Fan ovens cook more efficiently than conventional ovens – so adjustment to time and temperature may be required.

If, despite these recommendations, the problem continues, contact our Customer Care Centre.



The Customer Care Centre can be contacted on:

0871 22 22 502

Please get in touch if you experience any problems not covered here.

# Installation - Notes

---

## Installation

This information is intended for the installer, as the person responsible for assembly and electrical connection. If you install the oven yourself, the manufacturer will not be held responsible for any possible damage.

## Before Installation.

- An aperture is required in the kitchen unit to a minimum depth of 560mm.
- To fit the oven into this location, the back part of the unit must be clear of projections (reinforcements, pipes, sockets etc.)

Always ensure that this appliance is connected by a competent electrical installer who is a member of a recognised 'competent persons' scheme and who will comply with the I.E.E. and local regulations.

## Before you start

- Always make sure that you have carefully read through the installation pages of this book - careful planning at the beginning will ensure a quick and easy installation.
- Take care when moving this appliance, it may be heavier than it looks! If you need to lift the appliance, make sure you use an appropriate lifting method.
- Soft, or uneven flooring may be damaged unless the appliance is moved with care.
- DO NOT attempt to move the oven by pulling on the handles or doors, we recommend that you open the door and grasp the frame of the cooker. Please wear protective gloves for this, and make sure the door cannot trap your fingers.

Please make sure that you have enough space for your appliance, use the table and diagrams shown to help determine this.



After connecting the electricity, check that all the electrical parts of the oven are working.



Installation must only be performed by a fully qualified electrician who must ensure regulations in force for installation are observed.



Warning:  
This appliance must be earthed

# Installation – Diagrams

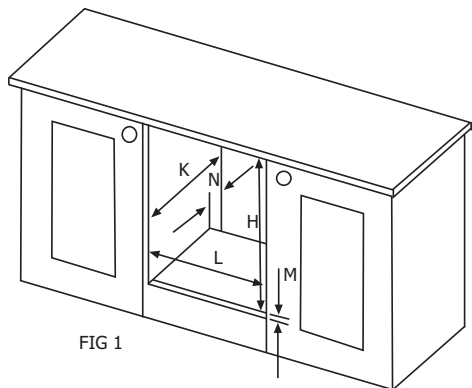

FIG 1

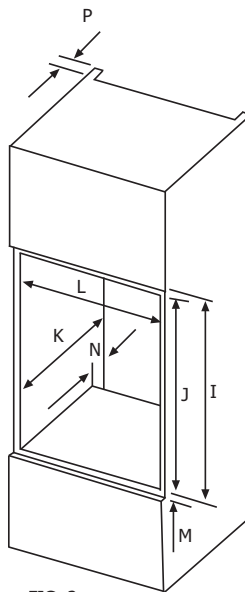

FIG 2

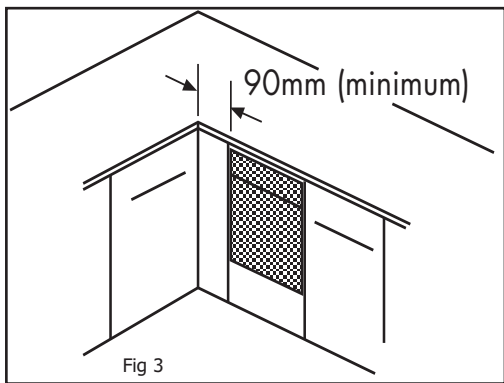

Fig 3

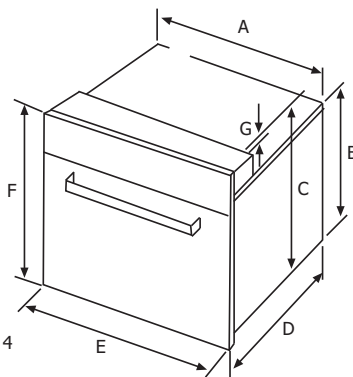

FIG 4

Product	Dimension (mm)														
	A	B	C	D	E	F	G	H	I	J	K	L	M	N	P
600mm	557.0	483.0	564.0	540.0	595.0	595.0	31.0	600.0	600.0	590.0	min 560	558 - 568	min 10	min 30	60 - 100



# Installation

---

- Leave the appliance in the base tray packaging until you are ready to install it. When you remove the appliance from the base tray packaging, take care not to damage it.
- Whilst every care is taken to eliminate burrs and raw edges from this product, please take care when handling - we recommend the use of protective gloves during installation.
- Please note that all dimensions and sizes given are nominal, some variation is to be expected.
- If this appliance is to be installed near to a corner where the adjacent cabinets run at right angles forward of the appliance, there must be a gap of at least 90mm between the appliance and the cabinets, to prevent overheating of the cabinets (FIG 3).

## **Important:**

- **Do not** modify the outer panels of this appliance in any way.

## **Fixing screws.**

The fixing screws are in a polythene bag in the oven pack.

Depending on the method of installation, some of the screws may not be needed.

If you have a non standard size of cabinet which leaves a gap above or below the appliance, you may be able to buy a trim kit (to fill in the gap) from the supplier of your cabinets.

# Installation – Into Oven Housing Unit

---

## **Refer to FIG.2 for the dimensional requirements.**

Remove the fixing screws from the polythene bag, but leave the appliance in the base tray packaging until you are ready to install it.

**Note:** When removing the appliance from the base tray packaging care should be taken not to damage the appliance, follow lifting instructions in the "Before you start" section.

1. When installing in a typical built in oven housing unit, the false back should be removed from the housing unit to provide the necessary depth for installation.
2. When the false back is removed, it is normally the case that the support shelf for the appliance leaves a gap between the back edge and the wall of approximately 80mm.
3. If no gap occurs between the back edge of the shelf and the wall behind the unit, a minimum gap of 30mm should be created by shortening the shelf, this is to provide adequate ventilation for the product.
4. Ventilation is required for the product, to allow it to function correctly, a cutout should cut into the top of the housing unit (see FIG.2), to provide this.
5. Slide the appliance into position and secure to the cabinet using the screws provided.

The appliance is designed to fit into a standard 600mm wide housing unit, with minimum internal dimensions as shown in FIG.2 of the installation dimensions.

Please note that all sizes are nominal, and some variation is to be expected.

# Installation – Under A Worktop

---

**Refer to FIG.1 for the dimensional requirements.**



Warning:  
This appliance must be earthed

**Where the appliance is installed under a worktop, with a hob installed above it, the installation instructions for the hob must be read in conjunction with these instructions.**

When installing a gas hob above the appliance, care must be taken to ensure the hob inlet pipe is as close to the back wall as possible, so it doesn't obstruct the oven.

If a flexible hose is used care must be taken not to trap it between the oven and the wall.

If the hob protrudes below the worktop you may have to lower the oven to compensate.

Remove the fixing screws from the polythene bag, but leave the appliance in the base tray packaging until you are ready to install it.

Note: When removing the appliance from the base tray packaging care should be taken not to damage the appliance, follow lifting instructions in the "Before you start" section.

1. When installing in a typical built under oven housing unit, the false back should be removed from the housing unit to provide the necessary depth for installation.
2. When the false back is removed, it is normally the case that the support shelf for the appliance leaves a gap between the back edge and the wall of approximately 80mm.
3. If no gap occurs between the back edge of the shelf and the wall behind the unit, a minimum gap of 30mm should be created by shortening the shelf, this is to provide adequate ventilation for the product.
4. Slide the appliance into position and secure to the cabinet using the screws provided.

The appliance is designed to fit into a standard 600mm wide housing unit, with minimum internal dimensions as shown in FIG.1 of the installation dimensions.

Please note that all sizes are nominal, and some variation is to be expected.

# Installation – Electricity Notes

## Electrical Connection - Legal Requirements.

### IMPORTANT:

We recommend that the appliance is connected by a qualified electrician, who is a member of the N.I.C.E.I.C. and who will comply with the I.E.E. and local regulations.

**Important:** Ensure that you route all mains electrical cables well clear of any adjacent heat source, such as an oven or grill.

**Warning:** This appliance must be earthed.

- Where a fixed connection is used, a device allowing the appliance to be isolated on all poles from the mains supply with a contact opening width of at least 3mm must be provided.
- The mains terminal block is positioned at the right hand rear of the top service panel.
- Connect the cable to the terminal block, and tighten the cable clamp.
- Close the terminal box, ensuring that the cover is engaged on the locking tabs.

After connection to the electricity supply please check that all electrical parts of the appliance are working.

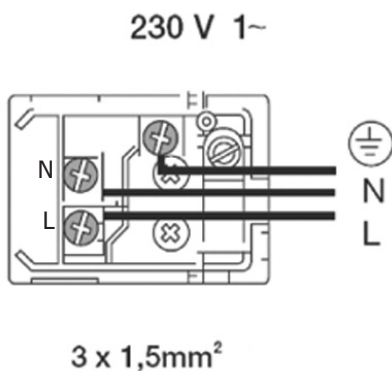

# Technical Data

---

## **Technical Information**

If the equipment does not work, please contact the Technical Service Department and advise them of the problem, indicating:

- Serial number.
- Appliance model.

When contacting the Customer Care Centre make sure you have the above numbers to hand. This will help us to process your call efficiently. There is space for recording the model and serial numbers at the back of this handbook.

You will find this information on the rating plate on the lower part of the oven when the door is opened. There is a space provided to record this at the back of this handbook.

The item that you have bought meets the European directives on electrical material safety (73/23/CEE) and electromagnetic compatibility (89/336/CEE).

# Technical Data

---

<b>@ 230v</b>		
		<b>S1 - E600F</b>
<b>Main cavity</b>		
	Fanned oven	2000 W
	Grill	2600W
<b>Extras</b>		
	Lights	25 W
	Fan	30 W
	Cooling fan	18 W
<b>Total wattage</b>		2673 W

Electrical rating: 220 – 240v ~ 50Hz/60Hz

Countries of Destination: GB (Great Britain) IE (Ireland).

Always make sure that any old appliances have been disposed of correctly – you should never attempt to dispose of any large appliance with household waste. Instead, please contact your local council / authority for information regarding the collection or re-cycling of such products.

Do not attempt to make any functional repairs on this appliance yourself, unless you are informed that you can either within this handbook, or by a qualified service engineer. If in doubt, please call the Customer Care Centre.

# Service Record

Date of purchase	Installer stamp / Printed name	Date of installation
Place of purchase:		

Date	Part(s) replaced	Engineers Stamp/ Printed Name

# Contact Us

---

Should you need to contact us, please call our Customer Care Centre on:  
**0871 22 22 502.**

Calls will be answered in strict rotation, as soon as possible.

Model Number									
Serial Number									

Please record your model and serial number in the spaces above.  
Having these numbers to hand will help us to help you quickly and more efficiently  
should you need to call us for any reason.





Stoves  
Stoney Lane, Prescot, Merseyside, L35 2XW

**03.2008 / 08 26277 02**  
**3172191 - 003**