

720G, Q721G

Gas Oven & Grill
For Natural Gas Models

User, Installation & Servicing Instructions

CONTENTS

User's Section	2 - 22
Introduction	2
Be Safe - Not Sorry	5
Using the grill	6
Using the Oven	9
Baking guide	11
Slow cooking	12
Cooking frozen & chilled foods	12
Traditional fruit cakes	13
Roasting turkey	13
Roasting guide	14
Automatic cooking	15
Programmer / Clock	17
Cleaning	21
Installation Instructions	23 - 35
Servicing Instructions	36 - 39
Technical Data	40
Stoves Customer Support	41

If you smell gas:

- Do not try to light any appliance.
- Do not touch any electrical switch.
- Call the Gas Emergency Helpline at TRANSCO on:

0800 111999

Please keep this handbook for future reference, or for anyone else who may use the appliance.

INTRODUCTION

Thank you for choosing a British built appliance by Stoves

We hope that the following information will help you to quickly familiarise yourself with the features of the appliance, and to use it successfully and safely.

Our policy is one of constant development and improvement. Strict accuracy of illustrations and specifications is not guaranteed. Modification to design and materials may be necessary subsequent to publication.

This appliance must be installed in accordance with the regulations in force and only in a well ventilated space. Read the instructions before using or installing this appliance.

The oven is designed to be installed underneath a worktop, either into a housing unit or between base units.

Your 1st Year Guarantee

To fulfil the conditions of your guarantee, this appliance must be correctly installed and operated, in accordance with these instructions, and only be used for normal domestic purposes.

Please refer to your Guarantee Card for further details.

Please note that the guarantee, and Service availability, only apply to the UK and Republic of Ireland.

Gas & Electrical connection

Please refer to installation instructions for the Gas & Electrical Safety Regulations and the Ventilation Requirements.

In your own interest, and that of safety, it is the law that all gas appliances be installed and serviced by competent persons, in accordance with "The Gas Safety (Installation & Use) Regulations 1994", & the "The Gas Safety (Installation & Use) (Amendment) Regulations 1996". Failure to comply with these Regulations is a criminal offence.

Corgi registered installers undertake to work to satisfactory standards.

Disconnection of gas and electric appliances should always be carried out by competent persons.

Warning: This appliance must be earthed.

The Gas Consumer Council (GCC) is an independent organisation which protects the interests of gas users. If you need advice, you will find the telephone number in your local telephone directory under Gas.

Before using the appliance for the first time, remove any protective polythene film and wash the oven shelves and furniture with hot soapy water to remove their protective covering of oil. Even so, when you first switch on the oven or grill, you may notice a smell and some smoke.

INTRODUCTION

Cooling fan

When the appliance is switched on, you will hear the cooling fan come on. This helps to keep the doors, facia and control knobs cool during cooking. Should any fault occur with the cooling fan, the appliance will need to be serviced - contact Stoves Customer Support.

When hot and cold air meet, there may be condensation. The outer door is cooler than the inner door, and some condensation is normal, and will disappear within 10 - 15 minutes.

Ventilation

The use of a gas cooking appliance results in the production of heat and moisture in the room in which it is installed. Ensure that the kitchen is well ventilated; keep natural ventilation holes open or install a mechanical ventilation device (mechanical extractor hood).

Prolonged intensive use of the appliance may call for additional ventilation, for example opening of a window, or more effective ventilation, for example, increasing the level of mechanical ventilation where present.

Glass door panels

To meet the relevant Standards of Domestic cooking appliances, all the glass panels on this appliance are toughened to meet the fragmentation requirements of BS3193. This ensures that, in the unlikely event that a panel breaks, it does so into small fragments to minimise the risk of injury.

Please take care when handling, using or cleaning all glass panels as any damage to the surfaces or edges may result in the glass breaking without warning or apparent cause at a later date. Should any glass panel be damaged, Stoves strongly recommend that it is replaced immediately.

In the event of a power cut:

1. Switch off the electricity supply to the appliance.
2. When the power returns, see the 'Programmer / Clock' section to '*Set the time of day*'.

INTRODUCTION

To replace a light bulb

Caution: Switch off the electricity supply to the appliance, to remove the risk of electric shock.

Wait until the oven /grill is cool before removing the shelves.

With a large flat bladed screwdriver or coin, prise off the lamp glass cover.

Unscrew the bulb and replace. replace lens cover.

Please note that oven light bulbs are not covered by guarantee.

Environmental Protection

Stoves Limited is committed to protecting the environment and operates an Environmental Management System which complies with BS EN ISO 14001:1996.

Disposal of packaging

- All our packaging materials are recyclable and environmentally friendly.
- Please help us to protect our environment by disposing of all packaging in an environmentally friendly manner.
- Please contact your local authority for the nearest recycling centre.

Caution: Packaging materials can pose a risk of suffocation - keep away from children.

BE SAFE - NOT SORRY

When you are cooking, keep children away from the vicinity of the appliance.

This product is designed as a domestic cooking appliance for the preparation and cooking of domestic food products, and should not be used for any other purpose.

- Remove all packaging from the appliance before using for the first time.
- Make sure you read and understand the instructions before using the appliance.
- Keep electrical leads short so they do not drape over the appliance or the edge of the worktop.
- Keep all flammable materials (such as curtains, furnishings & clothing) away from the appliance.
- Parts of the appliance may be hot during or immediately after use. Allow sufficient time for the appliance to cool after switching off.
- Do not drape tea towels over the flue vents or doors as this creates a fire hazard.
- When opening the appliance door, take care to avoid skin contact with any steam which may escape from the cooking.
- Switch off the electricity supply before replacing the oven light bulb, to avoid the risk electric shock.
- Do not use the oven with the door inner glass panel removed.

- Do not place items on the drop-down doors when they are open.
- Use oven gloves when removing hot food / dishes from the oven or grill. The oven / grill and utensils will be very hot when in use.
- Do not use aluminium foil to cover the grill pan, or put items wrapped in foil under the grill, as this creates a fire hazard.
- Do not use foil on oven shelves or allow it to block the oven flue, as this creates a fire hazard, and prevents heat circulation.
- When cooking heavy items - eg; turkeys - do not pull the oven shelf out with the item still on the shelf.
- Never use the appliance for heating a room.

All installation, servicing and maintenance work should be carried out by a competent person who will comply with current Regulations, Standards and Requirements.

Warning: This appliance must be earthed.

When you have finished cooking check that all controls are in the off position.

As with all gas appliances, it is recommended that your appliance is serviced regularly.

USING THE GRILL

Caution: Accessible parts may be hot when the grill is used, young children should be kept away.

Grill ignition

Important: The door must be fully open when the grill is used.

Open the grill door.

Push in and turn the grill control knob anticlockwise to the full-on position (large flame symbol).

Adjust to the required setting (there is a turn down to a slightly reduced setting).

Do not operate the grill between the "full on" flame setting and the "off" position.

If for any reason the burner fails to ignite, turn off the control and wait at least one minute before repeating the ignition procedure.

To *switch off*, turn the control knob clockwise to return it to the "off" position.

If the oven is set for automatic cooking, you can still use the grill, but the oven ignition will start.

Aluminium foil

Never cover the grill pan or grill trivet with cooking foil, or allow fat to build up in the grill pan, as this creates a fire hazard.

Detachable grill pan handle

Place the handle over the edge of the grill pan. The handle should be removed from the pan during grilling, to prevent overheating.

The handle is designed for removing / inserting the grill pan under the grill when grilling.

If cleaning the grill pan when it is hot, use oven gloves to move it. Do not use the handle to pour hot fats from the grill pan.



Grill pan trivet

Food for grilling should be placed within the area defined by the kinks in the trivet wires.

USING THE GRILL

Using the grill

Push the grill pan towards the back of the shelf, to position it under the grill.

Variation in grilling can be achieved by setting the grill between the large and small flame symbols, or by moving the grill pan up or down.

Important: Never operate the grill between the large flame and the off position.

The grill trivet, inside the grill pan, can be inverted to give a high or low position, or it may be removed.

Always use the top shelf position for fast toasting.

Always preheat the grill for a few minutes for best results.

When you have finished grilling, check that the control knob is returned to the off position.

USING THE OVEN

When you are cooking, keep children away from the vicinity of the oven.

Oven ignition

Push in and turn the oven control knob anticlockwise to gas mark 9.

When the oven is switched on the oven light will come on automatically.

It can take up to 60 seconds for the oven burner to come on to full rate, and the oven burner may not come on to full rate unless the oven door is closed.

The automatic ignition will continue to spark for a short time after the burner has lit until the flame is established.

Adjust to the required setting.

To switch off, return the control knob to the off position.

In the event of the burner flames being accidentally extinguished, turn off the burner control and do not attempt to re-ignite the burner for at least one minute.

Manual operation

The programmer must be set to manual before the oven can be used manually; if **A** (Auto) is showing on the programmer display, press the cook time **■** and ready time **⬆** buttons simultaneously to reset to manual operation.

Preheating

The oven must be preheated for 15 minutes when reheating frozen or chilled food, and we recommend preheating for yeast mixtures, batters, soufflés and whisked sponges.

If you are not preheating the oven, the cooking times in the Baking Guide may need to be extended, as they are based on a preheated oven.

Zones of heat

The temperature at the centre of the oven corresponds with the selected gas mark and is slightly higher towards the top of the oven and slightly lower towards the oven base.

These zones of heat can be useful as different dishes requiring different temperatures may be cooked at the same time - eg; the temperature at the oven base is suitable for cooking baked vegetables, baked fruit, milk pudding, etc, and for warming bread rolls, soup, coffee, or ovenproof plates and dishes.

If it is found over a period of time that the oven becomes hotter when used at a particular gas mark, the thermostat may need to be replaced.

USING THE OVEN

Baking tray and roasting tins

For best cooked results and even browning, the maximum size baking trays and roasting tins that should be used are as follows;

Baking tray 350mm x 280mm

This size of baking tray will hold up to 20 small cakes.

Roasting tin 370mm x 320mm

We recommend that you use good quality cookware. Poor quality trays and tins may warp when heated, leading to uneven baking results.

Oven shelves

The oven shelf must be positioned with the upstand at the rear of the oven and facing up.

Position baking trays and roasting tins on the middle of the shelves, and leave one clear shelf position between shelves, to allow for circulation of heat.

Slow cooking

- Make sure that frozen foods are thoroughly THAWED before cooking.
- Do not slow cook joints of meat or poultry weighing more than 2½kg / 4½lb.
- For roasting joints of meat or poultry and for pot roasts preheat the oven to gas mark 6 and cook for 30 minutes, then adjust the oven control to '**S**' slow set for the remainder of the cooking time.
- Always use the top half of the oven when slow cooking.
- Slow cooking times will be about three times as long as conventional cooking times.

USING THE OVEN

Baking guide

Dish	Recommended Gas Mark	Shelf Position	Approximate Cooking Time
Scones Meringues	7 "S" slow setting	top to middle middle to bottom	8 - 15 mins 2 - 3 hours
Cakes Small cakes Whisked sponge Swiss roll Victoria sandwich (2 x 180mm / 7") Genoise sponge Madeira (180mm / 7") Gingerbread Semi rich fruit cake (205mm / 8") Christmas cake Dundee cake (205mm / 8")	5 5 6 4 4 3 3 2 or 3 1 or 2 3	middle to top middle to top middle to top middle to top middle middle to bottom middle to bottom middle to bottom middle to bottom middle to bottom	15 - 25 mins 20 - 25 mins 20 - 25 mins 20 - 30 mins 20 - 30 mins 1 - 1½ hours 1 - 1½ hours 2½ - 3 hours depends on recipe 2 - 2½ hour
Pastry Flaky / Puff Shortcrust Choux Plate tarts (2)	7 6 6 6	middle to bottom middle to top middle to top middle to top	depending on size & type of dish, & also the filling
Biscuits Nut brownies Brandy snaps Flapjacks Ginger nuts	6 4 4 4	middle to top middle to top middle to top middle to top	15 - 20 mins 7 - 18 mins 20 - 40 mins 10 - 20 mins
Puddings Rice pudding (1 lt / 2 pint dish) Baked custard (1 lt / 2 pint dish) Bread & butter (2 pint dish) Hot soufflé Fruit crumble	2 3 3 4 6	middle to top middle to top middle to top middle to top middle to top	2 - 2½ hours 1 - 1½ hours ¾ - 1½ hours 35 - 50 mins ½ - 1 hour

USING THE OVEN

Cooking frozen & chilled foods

- Preheat the oven.
- When cooking frozen or chilled foods, please follow the manufacturer's instructions. If cooking more than one tray or item, cooking times may need to be increased.
- Please ensure that foods are piping hot before consumption.
- Always use the temperature setting stated on food packaging when cooking convenience food.
- Never overload the tray - eg; oven chips should be placed onto the baking tray in one even layer for satisfactory cooking.
- Follow the cooking times given on packaging but remember they are only intended as a guide and do not take individual preferences into account.
- Always cook frozen convenience foods straight from the freezer, unless packaging advises otherwise.

Baking guide - hints

To protect a very rich fruit cake during cooking, stand the tin larger tin or tie 2 layers of brown paper around the tin.

Cooking times for pastry dishes depend on the size and type of cooking dish and also the filling.

When cooking 2 trays of items, remove the top item when it is cooked and raise the lower item to the higher shelf to finish cooking, or where additional browning of the base is required - eg; pies and pastries - interchange part way through cooking.

USING THE OVEN

Traditional fruit cakes

It should be remembered that ovens can vary over time, therefore cooking times can vary, making it difficult to be precise when baking fruit cakes.

It is necessary therefore, to test the cake before removal from the oven. Use a fine warmed skewer inserted into the centre of the cake. If the skewer comes out clean, then the cake is cooked.

- Do not attempt to make Christmas cakes larger than the oven can cope with, you should allow at least 25mm (1 inch) space between the oven walls and the tin.
- Always follow the temperatures recommended in the recipe.
- To protect a very rich fruit cake during cooking, tie 2 layers of brown paper around the tin.
- We recommend that the cake tin is not stood on layers of brown paper, as this can hinder effective circulation of air.
- Do not use soft tub margarine for rich fruit cakes, unless specified in the recipe.
- Always use the correct size and shape of tin for the recipe quantities.

Roast turkey

Roasting turkey perfectly requires cooking two different types of meat - the delicate light breast meat, which must not be allowed to dry out, and the darker leg meat, which takes longer to cook.

The turkey must be roasted long enough for the legs to cook, so frequent basting is necessary. The breast meat can be covered once browned.

- Turkey should be roasted at gas mark 4 for 20 minutes per 1lb, plus 20 minutes, unless packaging advises otherwise.
- The turkey can be open roasted, breast side down, for half of the cook time, and then turned over for the remainder of the cooking time.
- If the turkey is stuffed, add 5 minutes per 1lb to the cooking time.
- If roasting turkey covered with foil, add 5 minutes per 1lb to the cooking time.

To test if the turkey is cooked, push a fine skewer into the thickest part of the thigh. If the juices run clear, the turkey is cooked. If the juices are still pink, the turkey will need longer cooking.

USING THE OVEN

Roasting guide

The times given in the roasting guide are only approximate, because the size and age of the bird will influence cooking times as will the shape of a joint and the proportion of the bone.

Frozen meat should be thoroughly thawed before cooking. For large joints it is advisable to thaw overnight.

Frozen poultry should be thoroughly thawed before cooking. The time required depends on the size of the bird - eg; a large turkey may take up to 48 hours to thaw.

Use of a trivet with a roasting tin will reduce fat splashing and will help to keep the oven interior clean. Alternatively, to help reduce fat splashing, potatoes or other vegetables can be roasted around the meat / poultry.

Notes:

- When cooking stuffed meat or poultry calculate the cooking time from the total weight of the meat plus the stuffing.
- For joints cooked in foil or covered roasters, and for lidded casseroles, add 5 minutes per 450g (1lb) to the calculated cooking time.
- Smaller joints weighing less than 1.25kg (2½lb) may require 5 minutes per 450g (1lb) extra cooking time.
- Position the oven shelf so that the meat or poultry will be in the centre of the oven.
- It is recommend that the appliance is cleaned after open roasting.

Cook in oven at gas mark 5		Approximate cooking time
Beef	Rare Medium Well Done	20 mins per 450g (1lb), plus 20 mins 25 mins per 450g (1lb), plus 20 mins 30 mins per 450g (1lb), plus 30 mins
Lamb	Medium Well Done	25 mins per 450g (1lb), plus 25 mins 30 mins per 450g (1lb), plus 30 mins
Pork		35 mins per 450g (1lb), plus 35 mins
Poultry		20 mins per 450g (1lb), plus 20 mins

USING THE OVEN

Automatic cooking

The automatic cooking facility is controlled by the programmer (see 'Programmer / Clock' section) and allows complete meals, or individual dishes to be cooked while you are out of the house, to be ready for when you return. The 'READY TIME' should be set as close as possible to, or just after, your anticipated return, so food is not left standing in a warm oven.

Do:

- Select foods which are fresh as possible, and as cold as possible - ie; preferably straight from the refrigerator.
- Choose foods which are suitable for cooking from a cold start, as some dishes will be affected by being left uncooked, at room temperature, perhaps for several hours - eg; a wet filling on a pastry base.
- Make sure that meat and poultry are thoroughly thawed (but still cold from the refrigerator) before placing them in the oven, and avoid using rolled joints of meat, which can be more susceptible to the growth of food poisoning organisms.
- Cover dishes with lids or foil to keep the food moist, and protect from possible contamination; the food can be uncovered towards the end of cooking to crisp and brown.

Do not:

- Warm food should never be placed in the oven if there is a delay period.
- Stews prepared by frying the meat and vegetables first should be cooked as soon as possible, or refrigerating prior to placing in the oven.
- Some dishes are not suitable for cooking on automatic - eg; dishes containing left over meat or poultry, dishes containing eggs, cooked rice, or seafood.
- Do not put food items (intended for automatic cooking) into a warm oven. Allow the oven to cool before setting for automatic cooking.
- Do not over fill dishes containing liquids, as they might boil over.
- Never leave food in the oven to cool slowly after cooking; serve immediately or refrigerate.
- Never use the automatic facility to reheat 'cook chill' foods, as they should go straight from the refrigerator into a preheated oven.
- To help keep foods as cool as possible before cooking, do not leave the oven lights on.

USING THE OVEN

Automatic cooking...

Important:



Food is more susceptible to the growth of food poisoning organisms in warm conditions. If the weather is hot, either take care to ensure that food is not left standing in a warm oven, or avoid using the automatic cooking facility.

Hints for automatic cooking

- Food is placed in a cold oven so you will need to add about 10 - 15 minutes onto the cooking time to allow for the oven to reach the selected temperature.
- Wine or beer may ferment, and cream may curdle during the delay period, so it is best to add these ingredients just before serving.
- Potatoes should be parboiled or brushed with oil to prevent discolouration during the delay period.
- Meat can be brushed with oil to prevent it drying.
- Lemon juice can be added to certain fruits and vegetables such as apples, pears, turnips and parsnips to prevent discolouration during the delay period.

PROGRAMMER / CLOCK

The Programmer Buttons

-  minute minder
-  cook time
-  ready time
- minus
- plus

To set the "Time of Day"

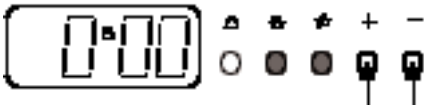

Press the *cook time* and *ready time* buttons simultaneously, and keep the buttons depressed. Use the *plus* and *minus* buttons to set the time of day, eg; 12.00.

A (Auto) symbol goes out, cookpot symbol comes on.

To select an alarm tone



Press the *minus* button to listen to the first tone.

Release the *minus* button and press it again to listen to the second tone, etc.

Releasing the *minus* button after the tone has sounded will automatically select that tone.

Manual operation



To set the programmer to manual operation at any time (cancelling any automatic setting), press the *cook time* and *ready time* buttons simultaneously. The programmer must be set to manual before the appliance can be used manually.

Setting the minute minder



Press the *minute minder* button, then use the *plus* and *minus* buttons to set the required time.

The minute minder (bell) symbol will appear on the display.

You can cancel the minute minder at any time by pressing the *minute minder* button and the *minus* button until the display returns to 0.00.

After setting, the display will revert to show the time of day, but you can press the *minute minder* button, and the display will show the minutes remaining.

The tone will sound at the end of the time set - to cancel the tone, press the minute minder button.

PROGRAMMER / CLOCK

Semi-automatic cooking (example)

You have started cooking a meal or dish in the oven, and want to set the time for the oven to switch off.

Press the *cook time* button, then use the *plus* and *minus* buttons to set the display to show the length of cooking time required, eg; 2 hours as shown **(1)**.

After setting, the display will revert to show the time of day, but you can press the *cook time* button and the display will show how much cooking time still remains on the clock.

Press the *ready time* button, and the display will show the actual time the oven is going to switch off, eg; 3.30 as shown **(2)**.

At the end of the cooking time, the alarm will sound, and the oven will automatically switch off.

To switch off the alarm, press the *minute minder* button **(3)**.

When the oven has switched off, **return the oven control knob to the "off" position**, and press the *cook time* and *ready time* buttons to return to manual operation **(4)**.

If you wish to cancel the automatic setting, or to cancel any remaining cooking time left on the clock before the alarm sounds, press the *cook time* and *ready time* buttons simultaneously. **(4)**.

1. A (Auto) symbol appears.



2.



3. A (Auto) symbol will flash.



4. A (Auto) symbol goes out.



PROGRAMMER / CLOCK

Fully automatic cooking (example)

For use when a delayed start time is required.

You want to set the length of cooking time, and the time for the oven to switch off. The programmer will automatically calculate the cooking start time.

Press the *cook time* button, then use the *plus* and *minus* buttons to set the display to show the length of cooking time required, eg; 2 hours as shown **(5)**.

Press the *ready time* button, and the present ready time will be displayed. Using the *plus* and *minus* buttons you can set the display to show the actual time you want the oven to switch off, eg; 18.00 hours (6.00 pm) **(6)**.

The display will revert to show time of day.

After setting the programmer, turn the oven control to the required temperature.

The oven will automatically switch on at the calculated start time of 16.00 hours (4.00 pm) **(7)**.

A single press of the *cook time* button shows the cooking time remaining before the oven automatically switches off **(8)**.

5. A (Auto) symbol appears.



6. The cookpot symbol will disappear from display.



7. The cookpot symbol will appear on display.



8.



PROGRAMMER / CLOCK

The oven will automatically switch off at 18.00 hours (6.00 pm) and the alarm will sound (9).

To switch off the alarm press the *minute minder* button (10).

When the oven has switched off, return the oven control knob to the "off" position, and press the *cook time* and *ready time* buttons simultaneously (11) to return to manual operation.

If you wish to cancel the automatic setting before cooking has started, and return to manual operation, press the *cook time* and *ready time* buttons simultaneously (11).

To cancel any remaining cooking time left on the clock before the alarm sounds, press the *cook time* and *ready time* buttons simultaneously (11).

9. A (Auto) symbol will flash.



10.



11. A (Auto) symbol goes out.



CLEANING

Caution: Any cleaning agent used incorrectly may damage the appliance.

Always let the oven cool before cleaning.

Some cooking operations generate a considerable amount of grease. This, combined with spillage, can become a hazard if allowed to accumulate on the appliance through lack of cleaning. In extreme cases this may amount to misuse of the appliance and could invalidate your guarantee.

It is recommended that the appliance is cleaned after open roasting.

Do not use caustic pastes, abrasive cleaning powders, coarse wire wool or any hard implements, as they will damage the surfaces.

All parts of the appliance can be safely cleaned with a cloth wrung out in hot soapy water.

Chrome plated parts

OVEN SHELVES & OVEN SHELF RUNNERS,
GRILL PAN TRIVET

Do not use abrasives or polishes, use a moist soap pad - eg; "Brillo".

Note: Oven shelf runners can be removed for cleaning. Grasp the runners, and slide out of the hanging holes as shown.

Note: These items may also be cleaned in a dishwasher.

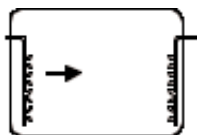

Vitreous enamel parts

GRILL PAN & GRILL COMPARTMENT, OVEN FLOOR

Use a mild cream cleaner. Look for one which has the Vitreous Enamel Development Council's Recommendation seal - eg; "Cif".

Stubborn marks may be removed with a moistened "Brillo" pad.

The grill pan may be cleaned in a dishwasher, or with a nylon brush in hot soapy water.

'Easy-care' surfaces

OVEN SIDES AND BACK

We recommend that the appliance is cleaned after open roasting, and also after roasting at temperatures higher than gas mark 5, to help prevent a build up of fats. Use of a trivet in a roasting tin when roasting will help reduce fat splashing.

Caution: Most types of cleaning agent will damage these surfaces.

Only use a few drops of washing up liquid in hot water. Wipe the surfaces with a clean cloth wrung out in hot soapy water - if larger splashes of fat do not readily disappear, scrub the area with a nylon brush or nylon pan scourer and hot soapy water. Rinse well and heat the oven to dry the surfaces.

Painted, plastic and metal finish parts (if fitted)

OVEN DOOR FRAME & HANDLE, CONTROL KNOBS

Only use a clean cloth wrung out in hot soapy water.

CLEANING

Glass parts

FACIA PANEL, OUTER & INNER DOOR GLASS PANELS

Use a mild cream cleaner - eg; "Cif". Rinse thoroughly and dry with a soft cloth.

Important: the inner door glass panel can be removed for cleaning but it must be replaced the right way up as shown (so the reflective side faces inwards), and pushed fully in to the stop position. To remove the glass panel, open the door wide, hold the top and bottom edges and slide out.

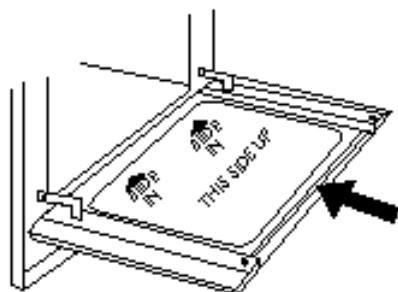

Stainless steel surfaces (stainless steel finish models only)

FACIA PANEL, HANDLES, DOOR CLADDING

Only use a clean cloth wrung out in hot soapy water, and dry with a soft cloth.

Stubborn marks can be removed using "Luneta". We recommend that you clean the whole of the stainless steel area to maintain a uniform finish. Supplies can be purchased from H.R.P.C. - contact direct sales order line © 01772 819 672.

Do not use undiluted bleach or any products containing chlorides as they can permanently damage the steel.

Extra care should be taken when cooking food in salted water. Some foods are corrosive - eg; vinegar, fruit juices and especially **salt** - they can mark or damage stainless steel if they are left on the surface. Turn off and wipe any spillage immediately, taking care to avoid skin contact with any hot surface or spillage.

Sharp objects can mark the surface of stainless steel, but marks will become less noticeable with time.

To maintain the finish of the stainless steel, or to remove any greasy marks, wipe the stainless steel surface sparingly with a *minimum* amount of "Johnson's Baby Oil" and kitchen paper. Do not use cooking oils, as these may contain salt, which can damage the stainless steel surface.

INSTALLATION INSTRUCTIONS

Before you start:

Please read the instructions, planning your installation will save you time and effort.

Check that your appliance is suitable for the gas supply in your house - ie; Natural Gas only. This is clearly marked on the data badge.

The appliance must be installed (and serviced) by a Corgi registered approved installer or a person competent to ensure that the installation is in accordance with "The Gas Safety (Installation & Use) Regulations 1994", & the "The Gas Safety (Installation & Use) (Amendment) Regulations 1996". Failure to comply with these Regulations is a criminal offence.

Where regulations or standards have been revised since this handbook was printed, always use the latest edition.

In the UK the regulations and standards are as follows:

1. Gas Safety Regulations 1996 (Installation and Use).
2. Building Regulations - Issued by the Department of the Environment.
3. Building Standards (Scotland) (Consolidated) - Issued by the Scottish Development Department.
4. The current I.E.E. Wiring Regulations.
5. Electricity at Work Regulations 1989.
6. BS 6172 Installation of Domestic Gas cooking Appliances
7. Installation & Servicing Instructions for this appliance.

Ventilation Requirements

The room containing the appliance should have an air supply in accordance with BS 5440: Part 2: 1989:

- All rooms require an openable window, or equivalent, and some rooms will require a permanent vent as well.
- For room volumes up to 5m³ an air vent of 100cm² is required.
- If the room has a door that opens directly to the outside, or the room exceeds 10m³ NO AIR VENT is required.
- For room volumes between 5m³ and 10m³ an air vent of 50cm² is required.
- If there are other fuel burning appliances in the same room, BS 5440: Part 2: 1989 should be consulted to determine the air vent requirements.
- This appliance must not be installed in a bed sitting room of less than 20m³ or in a bathroom or shower room.

Windows and permanent vents should therefore not be blocked or removed without first consulting a CORGI gas installer.

Failure to install appliances correctly is dangerous and could lead to prosecution.

INSTALLATION INSTRUCTIONS

Before you start - please read the instructions carefully - planning your installation will save you time and effort.

Look at the different ways the appliance can be installed - as shown on the following pages - and plan the installation to suit your situation.

Leave the appliance in the base tray packaging until you are ready to install it. When you remove the appliance from the base tray packaging, take care not to damage it.

Whilst every care is taken to eliminate burrs and raw edges from this product, please take care when handling - we recommend the use of protective gloves.

Please note that the weight of this appliance is approximately **47kg** (unpacked). Take care when lifting it into the housing unit - always use an appropriate method of lifting.

This appliance must be installed only at low level - ie; under a worktop. The controls have been designed for viewing at a low level, and it should therefore not be installed at high level.

Important: Do not modify the outer panels of this appliance in any way.

Please note that all dimensions and sizes given are nominal, some variation is to be expected.

If this appliance is to be installed near to a corner where the adjacent cabinets run at right angles forward of the appliance, there must be a gap of at least 90mm between the appliance and the cabinets, to prevent overheating of the cabinets.

Fixing screws - The fixing screws are in a polythene bag in the oven pack. Depending on the method of installation, some of the screws may not be needed.

Step 1: Prepare for installation

There are 3 methods of installing the appliance:

Method 1: Into a space between two base units, ie; without a housing unit.

Method 2: Into a housing unit, with an internal height of less than 710mm, which can be modified to obtain the required dimensions.

Method 3: Into a housing unit, with an internal height of 710mm or more.

If you have a non standard size of cabinet which leaves a gap above or below the appliance, you may be able to buy a trim kit (to fill in the gap) from the supplier of your cabinets.

Quantity	Colour	Description	For Fixing:
6	Silver	No 8 x 12mm long Self tapping screw	Runners to appliance
12	Black	No 8 x 12mm long Chipboard screw	Runners and sidetrims to cabinet or housing
4	Black	No 8 x 25mm long Chipboard screw	Appliance to cabinet
2	Silver	No 8 x 12mm long Self tapping screw	Appliance to sidetrims

INSTALLATION INSTRUCTIONS

Method 1: Without housing unit (between 2 base units)

Before installing the appliance, check the internal dimensions as shown opposite.

The space for the appliance must be clear of obstructions and there must be enough space at the back of the oven for the gas inlet pipe to hang freely. You may have to cut into or remove any rear cross members from the housing unit to obtain the 570mm minimum depth.

The fixing kit is packed onto the oven under the polystyrene packaging. You will find 2 side trims (692mm long) and 4 runners (420mm long). The fixing screws are in a polythene bag in the oven pack.

1. Take the 6 n° 8 x 12mm long silver self tapping screws from the polythene bag, and use them to fit one runner to each side of the appliance.
2. Make sure they are the right way up as shown.
3. Take one of the side trims, hold it against the side of the base unit, and mark off 692mm from the top edge of the base unit, to the top edge of the runner.
Note: This ensures a 5 - 8mm clearance from the underside of the worktop to the top of the appliance.
4. Measure 50mm from the front edge of the base units, to mark the front edge of the runners.
5. Take 6 of the n° 8 x 12mm (black) chipboard screws and screw the runners into position the right way up as shown.
6. Fit the side trims to be flush to the top and front edges of the base units, using the remaining 6 n° 8 x 12mm (black) chipboard screws.

INSTALLATION INSTRUCTIONS

Method 1: Without housing unit (between 2 base units)

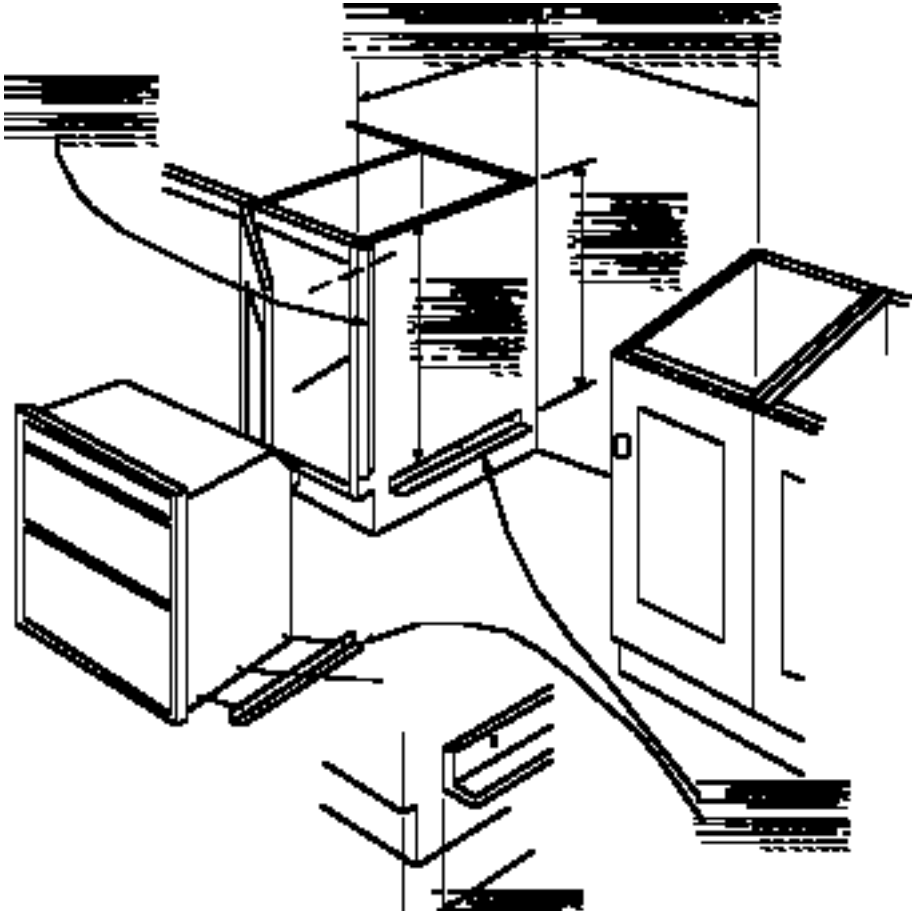

INSTALLATION INSTRUCTIONS

Method 2: Housing unit with internal height less than 710mm.

Note: You will not need the 2 side trims (692mm long) or the appliance runners for this installation. You will need the 2 runners to fix to the adjacent cabinets.

Before you start - make sure, before removing the bottom shelf or modifying the housing unit, that it will remain structurally sound - eg; by fixing to adjacent cabinets, floor or worktop.

There must be enough space at the back of the oven for the gas inlet pipe to hang clear of any obstructions. You may have to cut into, or remove, any rear cross members from the housing unit too obtain the 570mm minimum depth.

To obtain the required 715mm height, you may have to lower or remove the bottom shelf, remove any cross rails and reposition brackets.

Fix the runners:

1. Take the side trim, hold it against the side of the base unit, and use it to mark off 692mm from the top edge of the side unit to the top edge for the runner.

Note: This ensures a 5 - 8mm clearance from the underside of the worktop to the top of the appliance.

2. Measure 50mm from the front edges of the base units, to mark the front edge for the runners.
3. Take 6 of the n° 8 x 12mm (black) chipboard screws and screw the runners into position the right way up as shown.
4. If necessary, adjust the height of the plinth to just below the bottom edge of the runners.

INSTALLATION INSTRUCTIONS

Method 2: Housing unit with internal height less than 710mm.

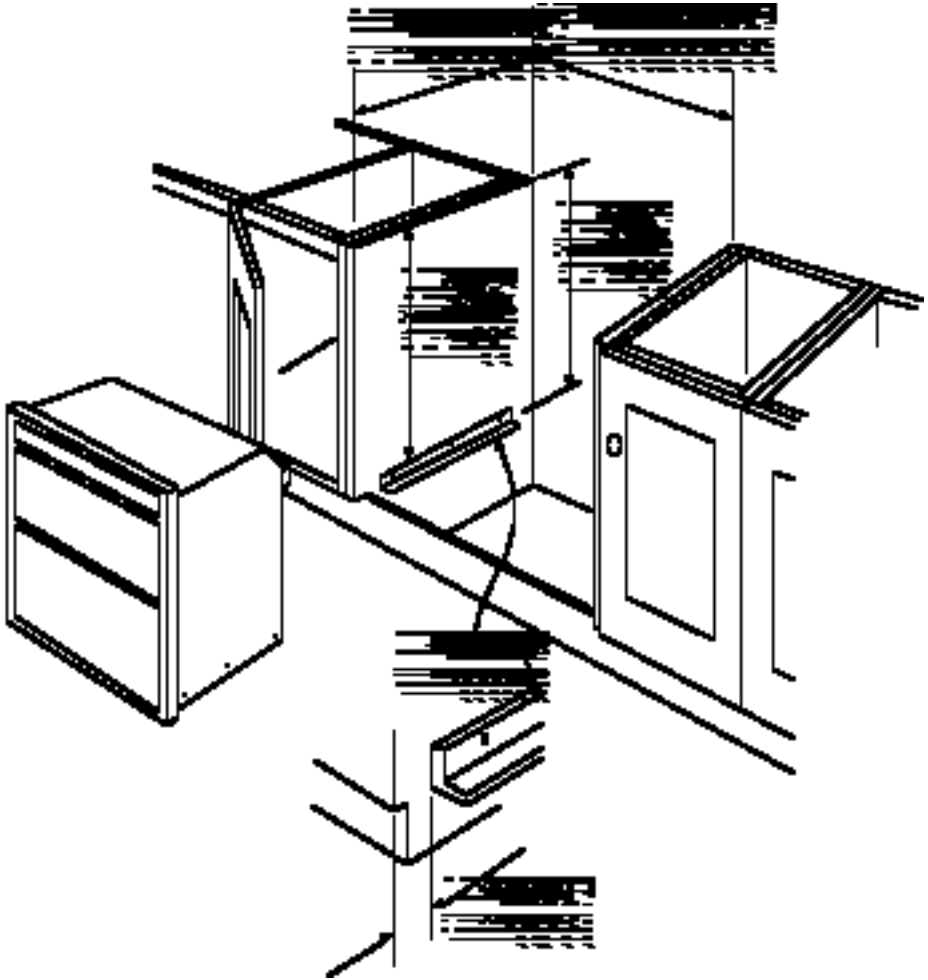

INSTALLATION INSTRUCTIONS

Method 3: Housing unit with internal height 710mm or more

Note: You will not need the 4 runners and 2 trims that are packed with the oven for this installation.

Remove any fixings that may prevent entry of the oven into housing, or obstruct the gas inlet pipe. The cabinetry should be kept structurally sound by fixing to adjacent cabinets, floor or worktop.

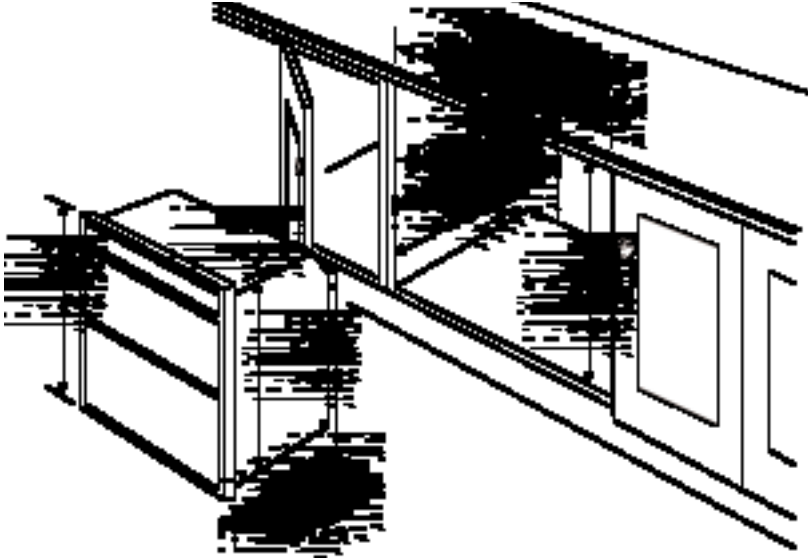

1. When installed in a typical 600mm deep built in housing unit, the false back should be removed from the housing unit to provide the necessary depth for installation.
2. When the false back is removed, it is normally the case that the support shelf for the appliance leaves a gap between the back edge and the wall of approximately 80mm.
3. If no gap occurs between the back edge of the shelf and the wall behind the unit, you must create a gap of at least 30mm by shortening the shelf.



INSTALLATION INSTRUCTIONS

Step 2: Connect to the electricity supply

This appliance must be connected by a competent person, using fixed wiring via a double pole switched fused spur outlet.

We recommend that the appliance is connected by a qualified electrician, who is a member of the N.I.C.E.I.C. and who will comply with the I.E.E. and local regulations.

Warning: This appliance must be earthed.

The wires in the mains lead are coloured in accordance with the following code:
Green & Yellow = earth,
Blue = neutral,
Brown = live.

As the colours of the wires in the mains lead for the appliance may not correspond with the coloured markings identifying the terminals in your spur box, proceed as follows:

1. The wire which is coloured green and yellow must be connected to the terminal marked **E** (Earth)  or coloured green.
2. The wire which is coloured blue must be connected to the terminal marked **N** (Neutral) LOAD or coloured Black.
3. The wire which is coloured brown must be connected to the terminal marked **L** (Live) LOAD or coloured Red.

If the supply cord is damaged, obtain a special cord from the Customer Support Helpline, which must be fitted by a qualified person.



INSTALLATION INSTRUCTIONS

Step 3: Connect to gas supply

1. The inlet to the appliance is $\frac{1}{2}$ " BSP situated towards the top right corner of the rear.
2. Fit the bayonet connection to the wall in the shaded area as shown. The shaded area shown is applicable to installations in minimum depth cabinets.
If more room is available, the bayonet fixing area can be extended, provided that the flexible tube does not obscure the fan intake.

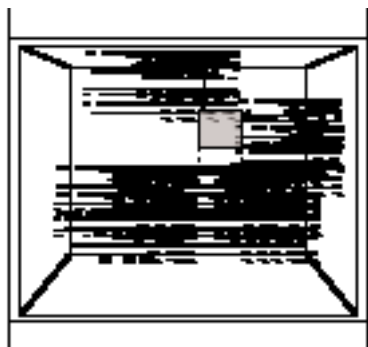

3. Use a 900mm - 1125mm length of flexible connector. The flexible connector shall be fitted such that it cannot come into contact with a moveable part of the housing unit (eg; drawer) and does not pass through any space susceptible of becoming congested. Make sure that the flexible connector does not block the cooling fan inlet.
4. Flexible connections should be to BS669. Parts of the appliance likely to come into contact with a flexible connector have a temperature rise less than 70°C.
5. Rigid connections must be accessible to disconnect for servicing. Cut a 150mm square hole in the right hand rear corner of the support shelf for the supply pipe.
6. **Make sure all connections are gas sound.**

INSTALLATION INSTRUCTIONS

Step 4: Fit edging strip (Q721G only)

Before inserting the appliance into the cabinet, fit the silicon edging strip (supplied in the oven pack) to the front side edges of the front frame.

Trim to size.

Fitting the edging strip:



Detail:



Step 5: Insert appliance and secure in position

Note: The unit housing the appliance must be appropriately fixed.

Method 1: Care must be taken to ensure the appliance runners are sufficiently engaged over the top of the runners on the base units.

Method 2: Insert appliance into cabinet - ensure that it is engaged over the top of the side runners.

Method 3: Insert appliance into cabinet.

To secure:

Make sure the appliance is centrally located.

Method 1: Open the grill door and you will see the 2 fixing holes at the top sides of the front frame. Drill through the fixing holes into the side trims with a 3.2mm diameter drill. Secure the appliance to the side trims with the 2 remaining n° 8 x 12mm (Silver) self tapping screws.

Methods 2 & 3: Open the grill door and secure appliance into position using 2 n° 8 x 25mm (Silver) chip-board screws through the front frame.

INSTALLATION INSTRUCTIONS

Step 6: Installing a gas hob above the appliance

Care must be taken to ensure that the hob inlet pipe is as close to the back wall as possible, so that it does not obstruct the appliance or the appliance inlet pipe.

If a flexible inlet pipe is used, it must hang vertically and not be trapped between the oven and rear wall.

Important: - ensure that you route all mains and electrical cables and flexible tubing well clear of any adjacent heat source, such as an oven, grill or hob.

INSTALLATION INSTRUCTIONS

Step 7: Commissioning

Burner aeration

All burners have fixed aeration and no adjustment is possible.

Pressure setting

G20 Natural Gas @ 20 mbar

Pressure test point - use oven injector.

Programmer

The programmer / clock must be set to the time of day before the oven can be used. See "Programmer / Clock" section to '*Set the Time of Day*'.

Electrical systems check

In the event of an electrical fault the preliminary electrical system check (earth continuity, short circuit, polarity and resistance to earth) must be carried out. There is also a fault finding section in the servicing instructions.

Ignition

The automatic ignition continues to spark for a short time after the burner has lit until the flame is established.

Oven

1. Push in and turn the control knob anticlockwise to Gas Mark 9.
2. Adjust to the required setting.
3. The burner may not come on to full rate unless the oven door is closed.

Note: The oven burner operates at a low rate for up to 60 seconds until the flame supervision device opens and full gas rate is obtained.

Grill

1. Open the grill door.
2. Push in and turn the control knob anticlockwise to the grill setting.

The grill light will come on automatically.

Before leaving the installation

Show the customer how to ignite the oven and grill, and give them this book. Thank you.

SERVICING INSTRUCTIONS

Before servicing - disconnect gas and electric supplies.

After servicing - check gas soundness.

For your safety, all servicing must be carried out by a competent person.

Wiring diagram	35
1. Remove appliance from housing	36
2. Facia panel.	36
3. Cooling fan.	36
4. Ignition generator	36
5. Oven / grill spindle mount switches.	36
6. Door frame(s)	36
7. Oven door glass panels	37
8. Programmer / clock.	37
9. Thermostat	37
10. FSD	37
11. Grill tap	37
12. Oven burner / electrode / injector	38
13. Grill electrode	38
14. Grill door glass panel	38
15. Grill / oven solenoids valve	38
16. Grill injector	38
17. Grill burner	38
18. Fan control PCB	39
19. Thermal cut out switch (manual reset, L120C)	39
20. Door seal	39

SERVICING INSTRUCTIONS

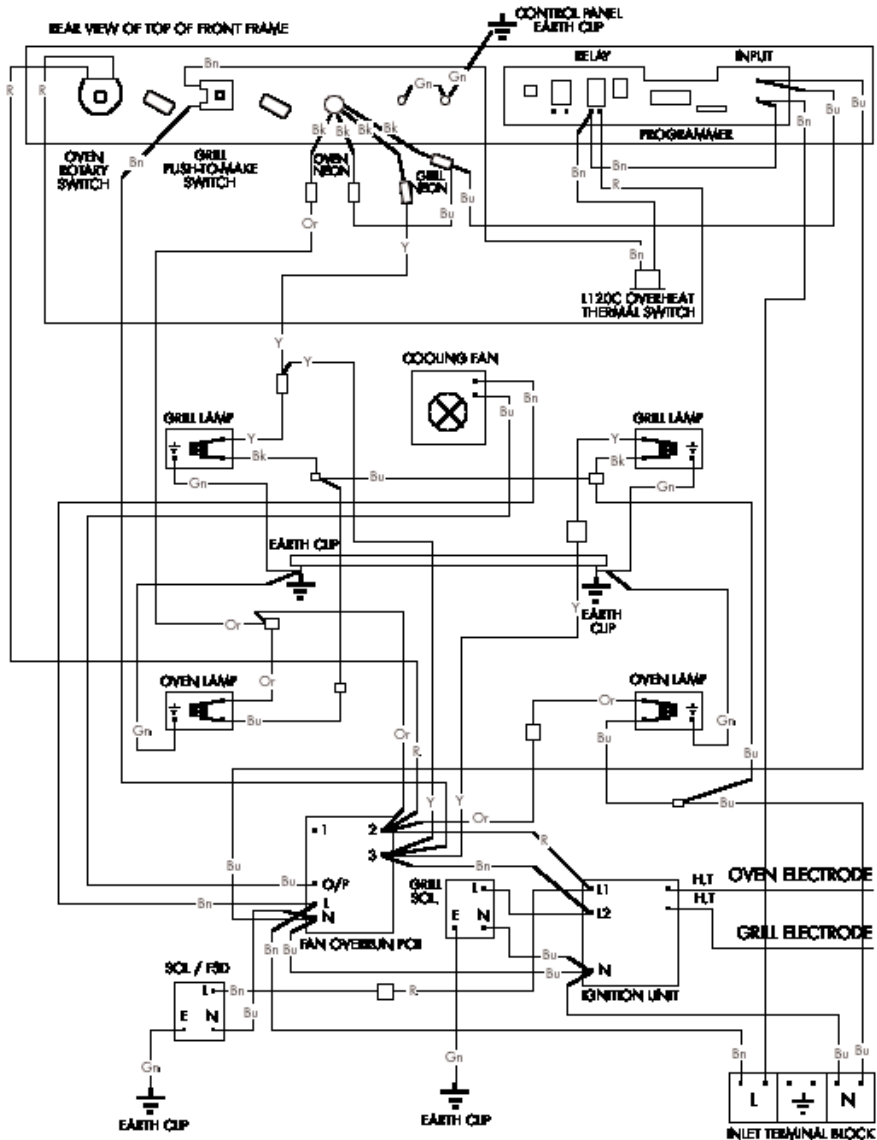

Wiring colour code: Bn = Brown, Bk = Black, Bu = Blue, Gn = Green, Y = Yellow, W = White, Or = Orange, R = Red.

SERVICING INSTRUCTIONS

1. Remove appliance from housing

- a. Disconnect the electricity supply.
- b. Open the grill door and unscrew the two screws through the front frame.
- c. Pull forward & out onto a suitable surface.
- d. Disconnect the gas supply inlet from the rear wall.

2. Facia panel

- a. Disconnect the electricity supply.
- b. Open the grill door and unscrew the two screws through the front frame.
- c. Pull forward & out onto a suitable surface.
- d. Pull off control knobs, & programmer buttons.
- e. **Q721G** - Open grill door & support the facia while unscrewing its securing screws from the rear of the frontframe the panel will now be free.
700G - Open grill door & support fascia while removing screws from underside of control panel - the panel will now be free.

3. Cooling fan

- a. Remove appliance from housing (1).
- b. Unscrew top / rear panel securing screws.
- c. Ease the panel backwards to gain access to the fan. Disconnect the 2 wires from the fan.
- d. Support the fan and remove the 4 fixing screws which secure the fan to the panel.
- e. Check thermal cutout switch is reset by pressing button on top of the switch.

4. Ignition generator

- a. Remove appliance from housing (1).
- b. Unscrew the top / rear panel securing screws. Ease the panel backwards, remove both fan leads & lift panel clear.
- c. Unscrew the 2 screws which secure the generator to the inner rear panel.

- d. Disconnect the leads.
- e. Reconnect leads to the new generator.

5. Oven / grill spindle mount switches

- a. Remove appliance from housing (1).
- b. Unscrew the top / rear panel securing screws. Ease the panel backwards, remove both fan leads & lift panel clear.
- c. Remove the fascia glass panel (2).
- d. Disconnect the outlet tubing connections from the thermostat and the grill tap.
- e. Remove the two screws securing the gas rail support bracket to the front frame.
- f. Remove the 2 screws securing the gas rail inlet pipe to the rear panel and lift the gas rail assembly away from the appliance.
- g. Remove circlip from grill tap spindle to allow removal of switch.
- h. Slide switch off the thermostat spindle.

6. Door frame(s)

- a. The oven inner glass panel is not secured to the frame & can be removed. Hold the top and bottom edges of the glass and slide out.
- b. Insert 2 screws through the inner holes in the door hinge arms (to stop the door from springing up).
- c. With the aid of a small screwdriver, prise out both inner door glass stops, near the bottom of each side extrusion.
- d. Slide door forwards off the plastic hinge blocks.

SERVICING INSTRUCTIONS

7. Oven door glass panels

- a. Open the door and insert 2 screws through the inner holes in the door hinge arms (to stop the door from springing up when you remove the outer glass panel).
- b. Slide out the inner glass panel.
Important: The inner glass panel must be replaced the right way up (so the reflective side faces the outer glass panel) and pushed fully in to the stop position.
- c. Hold the door handle as you unscrew the 2 corner screws through the door frame.
- d. Remove the outer glass panel by carefully pulling towards you.

8. Programmer / clock

- a. Disconnect the electricity supply.
- b. Remove the fascia glass panel (2).
- c. Disconnect the leads from the back of the programmer.
- d. Ease the PCB programmer off its supports.

9. Thermostat

- a. Remove appliance from housing (1).
- b. Unscrew the top / rear panel securing screws. Ease the panel backwards, remove both fan leads & lift panel clear.
- c. Remove the fascia glass panel (2).
- d. From inside oven, unclip the thermostat phial & feed out through the hole.
- e. Disconnect the outlet tubing connections from the thermostat and the grill tap.
- f. Remove the 2 screws securing the gas rail support bracket to the front frame.
- g. Remove the 2 screws securing the gas rail inlet pipe to the rear panel and lift the gas rail assembly away from the appliance.
- h. Remove the 2 screws through the thermostat bracket.

10. FSD

- a. Remove appliance from housing (1).
- b. Unscrew the top / rear panel securing screws. Ease the panel backwards, remove both fan leads and lift panel clear. From inside the oven remove the oven burner (13).
- d. Pull off the injector carrier positioning clip at RHS of oven burner bracket.
- e. Disconnect inlet pipe from FSD valve, this can now be removed complete with the injector carrier and probe.
Note: When replacing the injector carrier make sure the positioning clip is located into the groove.

11. Grill tap

- a. Remove appliance from housing (1).
- b. Unscrew the top / back panel securing screws. Ease the panel backwards, remove both fan leads and lift panel clear.
- c. Remove the fascia glass panel (2).
- d. Disconnect outlet tubing connections from the thermostat and the grill tap.
- e. Remove the two screws securing the gas rail support bracket to the front frame.
- f. Remove the 2 screws securing the gas rail inlet pipe to the rear panel and lift the gas rail assembly away from the appliance.
- g. Remove the 2 screws through the grill tap bracket.

SERVICING INSTRUCTIONS

12. Oven burner / electrode / injector

- a. From inside the oven remove the oven burner shield by slackening the single screw through the hole in the front of the oven burner shield, slide forward and lift off.
- b. Pull off the lead from the electrode at the LH end of the burner.
- c. Remove FSD probe from its securing clip.
- d. Unscrew the knurled nut from its securing clip.
- e. Ease forward off the locating screw, then slide to left to clear the injector.

13. Grill electrode

- a. Open grill door
- b. The electrode is secured by one screw to the grill burner.
- c. Disconnect the electrode lead.

14. Grill door glass panel

- a. Open the door and insert 2 screws through the inner holes in the door hinge arms (to stop the door frame springing back when you remove the glass panel).
- b. Unscrew the 2 corner screws through the door frame.
- c. Remove the glass panel by carefully pulling towards you.

15. Grill / oven solenoid valve

- a. Release appliance from housing unit (1).
- b. Unscrew the top / rear panel securing screws. Ease the panel backwards, remove both fan leads & lift panel clear.
- c. Release inlet & outlet pipes, disconnect the 3 wires and remove.

16. Grill injector

- a. Remove appliance from housing (1).
- b. Unscrew the top / rear panel securing screws. Ease the panel backwards, remove both fan leads and lift panel clear.
- c. Remove grill burner cover.
- d. Remove fixing screw from grill burner aeration cap.
- e. Lift grill burner & slide aeration cap off.
- f. Access the injector inside the aeration cap.

17. Grill burner

- a. Remove appliance from housing (1).
- b. Unscrew the top / rear panel securing screws. Ease the panel backwards, remove both fan leads and lift panel clear.
- c. Remove grill burner cover.
- d. Remove fixing screw from grill burner aeration cap.
- e. Lift grill burner & slide aeration cap off.
- f. Remove h.t. lead from grill electrode.
- g. Remove the 3 fixing screws securing the grill burner clamping plate to the inside of the grill cavity roof.
- h. The grill burner front will drop down away from the roof of the cavity and the remainder of the burner can be eased out.

SERVICING INSTRUCTIONS

18. Fan control PCB

- a. Release appliance from housing unit (1).
- b. Unscrew the top / rear panel securing screws. Ease the panel backwards, remove both fan leads and lift panel clear.
- c. Note the position of, then remove each wire from the PCB.
- d. Remove PCB from the plastic mounts.
- e. Fit new PCB and reconnect wires

19. Thermal cut out switch (manual reset, L120C)

- a. Release appliance from housing unit (1).
- b. Unscrew the top / rear panel securing screws. Ease the panel backwards, remove both fan leads and lift panel clear.
- c. Remove 2 screws securing thermal cutout switch to inner grill cover and replace.

20. Oven / grill neons

- a. Remove appliance from housing (1).
- b. Unscrew the top / rear panel securing screws. Ease the panel backwards, remove both fan leads and lift panel clear.
- c. Remove the fascia glass panel (2).
- d. Disconnect the relevant neon assembly flying leads and remove neon assembly.
- e. Replace in reverse order.

21. Door seal

- a. Pull off the old seal.
- b. Slacken the screws in the stainless steel flue cover at front of oven / grill roof, to ease insertion of the seal.
- c. Partly open the door to obtain best access for the seal all around the oven / grill.
- d. Applying washing up liquid to the rear tongue of the seal will help insertion.
- e. Locate the middle of the new seal and start to push into place at the middle of the bottom edge of the cavity.
- f. Make sure the narrow gap goes to the inside, & locates onto the oven cavity.
- g. **Do not stretch** the seal.
- h. Make sure the seal is fitted correctly as shown, and cut to fit.
- i. Re-tighten the screws in the flue cover.

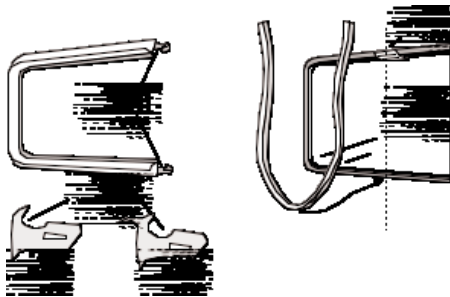

TECHNICAL DATA

Data badge

Front frame

Type of gas

This appliance must only be used with Natural Gas.

Gas category

Natural Gas - I₂H, G20 @ 20mbar

Pressure setting

20 mbar

Pressure test point - use oven injector

Ignition

2 outlet re-ignition generator

Appliance class

Class 3, Built-In Oven & Grill

Light bulbs

2 grill & 2 oven 4 x 25W

Electrical supply

230 - 240V ~ 50Hz

Grill

- *Burner* - Bray surface combustion type
- *Spark gaps* 3 - 4mm
- *Nominal Rate Q_n* 2.25kW
- *Injector (Copreci)* 1.12mm

Oven

- *Burner* - Bray type burner, sheet steel body, stainless steel flame strip
- *Nominal Rate Q_n* 2.5kW
- *Injector* 1.15mm

Total Heat Input

ΣQ_n 4.75kW

Countries of destination

GB - Great Britain, IE - Ireland

STOVES CUSTOMER SUPPORT

In case of difficulty please call
STOVES Customer Support Helpline on

0151 432 7838

When you dial this number you will hear a recorded message and be given a number of options. This indicates that your call has been accepted and is being held in a queue. Calls are answered in strict rotation as our Customer Support Representatives become available.

Opening Hours for Customer Support

Monday to Friday	8am - 8pm
Saturday	8.30am - 6pm
Sunday	10am - 4pm

Enter appliance numbers here for future reference:

Model No									
<input type="text"/>	<input type="text"/>	<input type="text"/>	<input type="text"/>	<input type="text"/>	<input type="text"/>	<input type="text"/>	<input type="text"/>	<input type="text"/>	<input type="text"/>
Serial No									
<input type="text"/>	<input type="text"/>	<input type="text"/>	<input type="text"/>	<input type="text"/>	<input type="text"/>	<input type="text"/>	<input type="text"/>	<input type="text"/>	<input type="text"/>

Please ensure you have the above details (Model No and Serial No) to hand when calling Stoves Customer Support. They are essential to booking your call.

