

605MF

Electronic Multifunction Oven / Grill

User & Installation Instructions

STOVESTM

Contents

User's Section	2 - 18
Introduction	2
Be Safe - Not Sorry	4
Functions	6
Using the grills	7
Grilling guide	10
Using the main oven	12
Main oven guides	16
Roasting guides	18
Traditional Fruit cakes	19
Roast Turkey	19
Programmer / Clock	21
Cleaning	28
Installation Instructions	31
Technical Data	34
Stoves Customer Care	Back page

Please keep this handbook for future reference, and for anyone else who may use this appliance.

Introduction

Thank you for choosing a British Built appliance by Stoves

We hope the following information will help you to quickly familiarise yourself with the features of the appliance, and to use it successfully and safely.

Our policy is one of constant development and improvement. Strict accuracy of illustrations and specifications is not guaranteed. Modification to design and materials may be necessary subsequent to publication.

Please read the instructions in this handbook before using or installing this appliance.

This appliance is designed to fit into a standard 600mm wide housing unit with a minimum internal height of 580mm.

Your 1st year guarantee

To fulfil the conditions of your guarantee, this appliance must be correctly installed and operated, in accordance with these instructions, and only be used for normal domestic purposes.

Please note that the guarantee, and Service availability, only apply to the UK and Republic of Ireland.

Environmental Protection

We are committed to protecting the environment and operate an Environmental Management System which complies with BS EN ISO 1400.

Before using your appliance.

Remove any protective polythene film and wash the oven shelves and furniture

in hot soapy water to remove their protective covering of oil. Even so, when you first turn on the oven or grill you may notice a smell and some smoke.

Disposal of packaging

- All our packaging materials are recyclable and environmentally friendly.
- Please help us to protect our environment by disposing of all packaging in an environmentally friendly manner.
- Please contact your local authority for the nearest recycling centre.

Caution: Packaging materials can pose a risk of suffocation - keep away from children.

Electrical connection

Please refer to installation instructions for electrical connection.

In your own interest, and that of safety, make sure that any installation/disconnection is carried out by a competent person.

Warning: This appliance must be earthed.

Steam cleaners should not be used to clean this appliance.

Introduction

When the power is turned on.

As soon as the power is switched on, the oven will run a brief self check.

Once this has been done, the timer display in between the central and right hand control knob will begin to flash.

We recommend that you set the correct time of day before using the appliance for the first time.

If the time of day is not set after **one minute**, the timer display will show "00.01" as the time.

Please remember that this is a **24 hour** timer.

Manual operation

Always make sure that the appliance is in manual cooking mode before using it. The Automatic programmer will not allow the oven/grill to be used if it is waiting to run a programme.

To change an oven light bulb

Switch off the electricity to the appliance at the socket, to avoid the risk of electric shock.

Wait until the oven is cool, then remove the oven shelves.

The lens cover on the light can be removed by pulling away from the oven side. Unscrew the bulb and replace.

Please note that oven light bulbs are not covered by guarantee.

Cooling fan

When any oven or grill heating function is selected the cooling fan will operate and continue to operate continuously and for 15minutes after the last heating

function has been switched off, unless any oven or grill heating element has not operated for longer than 90 seconds.

In this case the cooling fan will switch off immediately.

In all cases the cooling fan will switch on if it detects a temperature of 150°C or above and will not switch off until the temperature is 150°C or below.

In the event of a power cut:

1. Switch off the electricity supply to the appliance.
2. When the power returns, see the 'Programmer / Clock' section to 'Set the time of day'.

Condensation

When hot moist air, created when cooking, meets a cooler surface such as an oven door, then the formation of condensation is normal, especially when cooking wet dishes at low temperatures.

Note: Automatic cooking will normally produce condensation when cooling down and food is still in the oven.

To minimize this:

Most importantly - pre-heat the oven on a high temperature before putting food into the oven

also - Cover the food you are cooking

Where possible cook wet food at higher temperatures

Do not leave food in the oven to cool down

Be Safe - Not Sorry

When you are cooking, keep children away from the vicinity of the appliance.

This product is designed as a domestic cooking appliance for the preparation and cooking of domestic food products, and should not be used for any other purpose.

- Remove all packaging, protective films and oils from the appliance before using for the first time.
- Make sure you read and understand the instructions before using the appliance.
- Keep electrical leads short so they do not drape over the appliance or the edge of the worktop.
- Keep all flammable materials (such as curtains, furnishings & clothing) away from the appliance.
- Parts of the appliance may be hot during or immediately after use. Care should be taken to avoid touching the heating elements inside the oven. Allow sufficient time for the appliance to cool after switching off.
- During use, the oven interior becomes hot, care should be taken to avoid touching heating elements inside the oven - children should be kept away.
- Never use the appliance for heating a room.
- Switch off the electricity supply before replacing the oven light bulb, to avoid the risk electric shock.

- Do not drape tea towels over the handle as this creates a fire hazard.
- When opening the appliance door, take care to avoid skin contact with any steam which may escape from the cooking.
- Do not place items on the drop-down door when it is open.
- Do not use the oven with the door inner glass panel removed.
- Do not use aluminium foil to cover the grill pan, or put items wrapped in foil under the grill, as this creates a fire hazard. The high reflectivity can also damage the element.
- Use oven gloves when removing hot food / dishes from the oven or grill. The oven / grill and utensils will be very hot when in use.
- Do not use foil on oven shelves or allow it to block the oven flue, as this creates a fire hazard, and prevents heat circulation.
- When cooking heavy items - eg; turkeys - do not pull the oven shelf out with the item still on the shelf. Unless the appliance is fitted with telescopic shelving.

All installation, servicing and maintenance work should be carried out by a competent person who will comply with current Regulations, Standards and Requirements. Always ensure the appliance is switched off after use.

Be Safe - Not Sorry

Important safety note:







This appliance has built in fail safe technology to prevent your appliance from overheating in the event of misuse or certain component failures such as cooling fan failure.

Should any of the above occur the appliance will automatically show "FAIL" "FAIL" on both displays.

You should switch off the power to the appliance and call our Customer Care Centre - details on the back page.

The appliance will automatically reset itself when the appliance is fully-cooled down and power is restored.

Appliance Functions

Symbol	Function / Feature	Main Oven and Grill
	Full Grill (conventional)	✓
	Half Grill (economy - inner element only)	✓
	Fanned grill	✓
	Conventional oven	✓
	Fanned oven	✓
	Intensive bake	✓
	Defrosting	✓

Details of how to use these functions are detailed in the handbook in the 'Using the grill' and 'Using the oven' sections.

Using the Grills

Caution: Accessible parts may be hot when the grill is used, young children should be kept away.

The 605MF is a combined oven and grill unit. You cannot use the oven and the grill simultaneously.

Before using the grills

If you have programmed one of the ovens for automatic cooking, then the grill functions will not be available for use, please check that the oven is not set for automatic cooking before use.

Preheating

This appliance performs at it's best when it is preheated.

To show it is preheating, the 'gr' flashes on the display.

Once preheating has finished, you will hear a short audible tone, and the 'gr' will stop flashing.

The grill is now ready to use.

Aluminium foil

Using aluminium foil to cover the grill pan, or putting items wrapped in foil under the grill can create a fire hazard, and the high reflectivity can damage the grill element.

Detachable grill pan handle

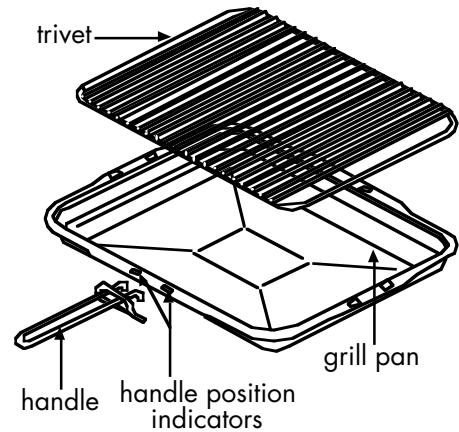

Place the handle over the edge of the grill pan, at the narrow side edges. Slide the handle to the centre, and locate between the handle position indicators.

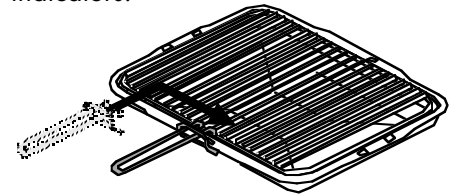

The handle should be removed from the pan during grilling, to prevent overheating.

The handle is designed for removing / inserting the grill pan under the grill when grilling.

If cleaning the grill pan when it is hot, use oven gloves to move it. *Do not* use the handle to pour hot fats from the grill pan.



Food for grilling should be positioned centrally on the trivet.

Using the Grills

Using the Grill functions

The grill is controlled by the right hand control knob, the energy levels are shown on the left hand display, while the time of day is shown on the right hand display.

Important note: There are three grill functions available:

Full Grill		Door open when using
Half Grill		Door open when using
Fanned Grill		Door closed when using

To activate the grill, press the right hand control knob once. An audible tone will sound.

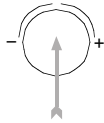

The full grill icon will come on flashing. This is the default setting.



You can select a different function by turning the right hand control knob anti-clockwise, or clockwise the function icons will remain flashing while you do this.

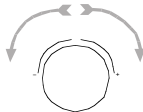

Once you have chosen which function you wish to use, press the control knob once, to confirm your choice. An audible tone will sound.

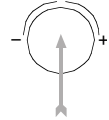

Your selected icon will remain lit and the default energy setting, gr:10 will be displayed on the Left hand display. This will flash while the grill preheats.

The grill will then start working, and the lights will switch on inside the cavity.

You can adjust the energy setting by turning the right hand controller either anti-clockwise or clockwise and adjusting between gr:1 - low, or, gr:10 - high.

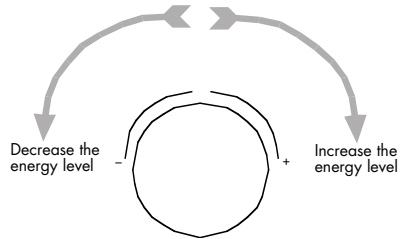

To switch off.

Press the right hand control knob once cooking has finished. This will turn off the appliance and it will begin to cool down.

The main oven/grill left hand display reverts back to the temperature display of the main oven.

Using the Grills

When using the grill

You cannot use the automatic programmer with the grill, however the minute minder function can be used.

(see Programmer/Clock section)

Never leave the grill unattended for long periods of time when it is in use, if you do leave the appliance - set the minute minder as a reminder.

The grill is recommended for toasting bread, and grilling foods such as steaks, sausage and bacon.

If you use the fanned grill function, you do not need to turn thinner foods such as bacon, fish and gammon streaks.

Always remember when you use the grill that the Fanned grill function must have the door closed, while the Full and Half grill must have the door open.

Note:

If you accidentally knock the grill control, the Full grill icon will come on flashing - however it will not activate the grill and after a short time will turn off again automatically.

Grilling Guide



Grilling guide

The times given in the grilling guide are based on a **pre-heated** full grill used on gr:10. They are only approximate as differences in thickness, size of portion, and personal preference will influence the timing.

Shelf positions are counted from the bottom position up.

Food	Shelf position	Grilling times (mins)	
		conventional	fanned
Bread			
Toast; 3 - 4 rounds	14	2 - 4 mins	-
Teacakes	11	2 - 4 mins	-
Cheese on toast;			
- 4 rounds - full	12	3 - 5 mins	-
- 2 rounds - single	12	3 - 5 mins	-
Fish			
Fish fillets (6 - 8 oz)	12	6 - 10 mins	6 - 10 mins
Poultry			
Chicken fillets (6 - 8 oz)	12	15 - 25 mins	-
Chicken joints	11	20 - 40 mins	-
Meat			
Bacon Rashers	14	10 - 12 mins	6 - 8 mins
Sausages	13	15 - 20 mins	-
Steak - rare	15	7 - 10 mins	7 - 10 mins
- medium	14	10 - 15 mins	10 - 15 mins
- well done	13	15 - 20 mins	15 - 20 mins
Lamb chops	12	10 - 15 mins	-
Pork chops	12	12 - 20 mins	-
Gammon steaks	13	12 - 15 mins	10 - 15 mins

Using the Grills

Grill Function		Pre-set Temperature °C Pre-set Energy Level	Recommended Uses
	Half Grill (economy)	gr:10 - highest grill setting	The half grill uses part of the element and is ideal for grilling smaller amounts of foods like steaks, bacon and toast. Use with the door open
	Full Grill (conventional)	gr:10 - highest grill setting	The full grill allows you to cook foods such as toast, bason and steaks using heat from the element above. The full grill is ideal for large amounts of food. Use with the door open.
	Fanned Grill	gr:10 - highest grill setting	Suitable for thinner, flatter foods such as bacon, fish and gammon steaks. Foods do not require turning during cooking. Use with the door closed.

- These functions are all accessed by using the right hand control knob to switch on, select, confirm and switch off.
- The right hand control knob is also used to set energy level.

Using the Oven

Using the oven

Please read through these instructions carefully before using for the first time.

Never put items directly on the base of the oven or cover the oven base with foil, as this can cause the base element to overheat.

Preheating

The oven performs at it's best when preheated.

We recommend that you turn the oven on, select the function you require, and allow it to preheat before you put any foods or dishes in to cook.

While the oven is preheating, the temperature display will show the desired temperature and the °C symbol (shown below will flash).



Once the oven completes it's preheat the °C will stop flashing and an audible tone will be heard.

To help the air circulate freely

- Position the shelves evenly within the oven and maintain a clearance from the oven roof and base.
- If more than one cooking dish or baking tray is to be used on a shelf, leave a gap of at least 25mm between the items themselves and the oven interior.
- Allow enough space between shelves for food that will rise during cooking.
- Do not place items on the oven base as this will prevent air from circulating freely.

Using the Oven

Caution: Accessible parts may be hot when the ovens are used, young children should be kept away.

The oven is a multi-function oven. It has a variety of functions which can be used to achieve different results.

Manual operation

Please ensure that the oven is not automatically programmed when you start cooking. A small LED in the bottom right corner of the timer/clock will be lit if the auto programmer is active.

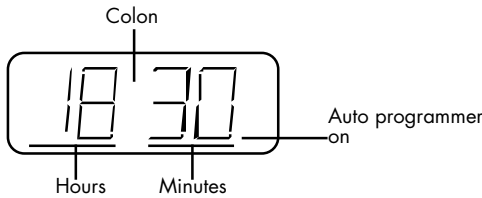

To turn on the oven

Step 1 - Select the function

Press the left hand control knob once, a short audible tone will sound

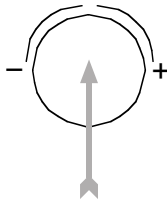

The oven will automatically default onto the fan oven.



To change the function turn the knob until the icon for the function you require is illuminated.

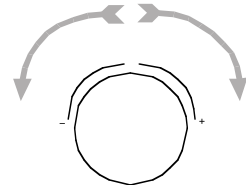

Press the control knob again to confirm your choice a short audible tone will sound

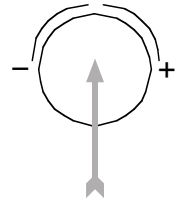

The oven has pre-set temperatures programmed in - detailed on page 19. Details about the temperature settings, and how to adjust them are on the following page.

Using the Oven

Step 2 - Select the temperature

Once the oven function has been selected and confirmed, the preset temperature will show in the left hand display.

To adjust the pre-set temperature, just turn the knob until the display on the left reads the temperature you require.

Note:

If you accidentally knock the oven control, the Fanned oven icon will come on flashing - however it will not activate the oven and after a short time will turn off again automatically.

Automatic operation

See 'Programmer / Clock' section.

1) Pre-set temperature



2) Turn

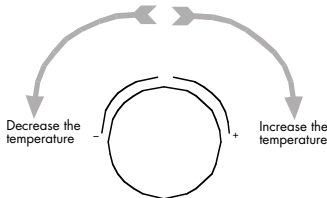

3) Adjusted temperature



Using the Oven

Defrosting and cooling

Important notes:

To **defrost** frozen foods, place food in the centre of the oven and close the door.

To **cool** foods after cooking prior to refrigeration or freezing, place food in the centre of the oven with the door open.

Be safe

- Do not defrost stuffed poultry using this method.
- Do not defrost larger joints of meat or poultry over 2kg / 4lb using this method.
- Never place uncooked food which is to be defrosted next to cooked food which is to be cooled, as this can lead to cross contamination.



Defrosting times

Small or thin pieces of frozen fish or meat - eg; fish fillets, prawns and mince will take approximately 1 - 2 hours. Placing the food in a single layer will reduce the thawing time.

A medium sized casserole or stew will take approximately 3 - 4 hours.

A 1.5kg / 3lb chicken will take approximately 5 hours - remove the giblets as soon as possible.

Using The Main Oven



Dish	Recommended Temperature °C			Shelf	Approx Cook Time (mins)
	Conventional 	Fanned 	Intensive 		
Scones	215	200	200	6 & 12	8 - 15
Meringues	120	110	110	12	2 - 3 hrs
Cakes					
Small cakes	180	175	175	10	20 - 25
Whisked sponge	190	175	175	9	20 - 25
Swiss roll	200	190	190	5	10 - 12
Victoria sandwich (2 x 180mm / 7" per shelf)	180	160	160	7	20 - 30
Genoise sponge	180	160	160	8	25 - 30
Madeira (180mm / 7")	170	150	150	5	1 - 1½ hrs
Semi rich fruit cake (205mm / 8")	150	135	135	5	2½ - 3 hrs
Dundee cake (205mm / 8")	150	135	135	5	2½ - 3 hrs
Pastry					
Flaky / Puff	220	200	200	15 - 45 mins. Depending on recipe and type of filling.	
Shortcrust	200	180	180		
Choux	200	180	180		
Plate tarts (2 x 180mm / 7")	200	180	180		
Biscuits					
Shortbread rounds	180	160	160	10	10 - 20
Nut brownies	180	160	160	9	35 - 40
Brandy snaps	190	170	170	9	8 - 12
Flapjacks	190	180	180	9	25 - 40
Ginger nuts	180	160	160	9	15 - 20

Notes:

Shelf positions in an electric oven are counted from the bottom position up.

For best results when using the conventional oven cooking function, only one tray of cakes or scones should be baked. When baking more than one tray, the fanned oven cooking function should be used.

Using The Main Oven

Dish	Recommended Temperature °C			Shelf	Approx Cook Time (mins)
	Conventional 	Fanned 	Intensive 		
Puddings					
Rice pudding (1 / 2 pint dish)	150	140	140	6	1¼ - 2hrs
Baked custard (1 / 2 pint dish)	170	150	150	6	50 - 60
Bread & butter pudding (1 / 2 pint dish)	170	150	150	6	45 - 1hr
Hot soufflé	180	160	160	7	30 - 45
Fruit crumble	200	185	185	9	40 - 1hr
Miscellaneous					
Yorkshire pudding (large)	220	200	200	11	40 - 45
Yorkshire pudding (small)	220	200	200	12	15 - 20
Toad in the hole	220	200	220	11	40 - 45
Bread (2 x 1lb loaves)	220	200	200	7	20 - 30
Bread rolls	220	200	200	10	10 - 15

Using The Main Oven

Roasting guide

Frozen meat should be thoroughly thawed before cooking. For large joints, it is advisable to thaw overnight.

Frozen poultry should be thoroughly thawed before cooking (unless packaging advises otherwise). The time required depends on the size of the bird - eg; a large turkey may take up to 48 hours to thaw.

Adjust the shelf positions so the meat or poultry will be in the centre of the oven.

The times given in the roasting guide are only **approximate** because the size and age of the bird will influence cooking times, as will the shape of the joint and the proportion of bone.

Cook in oven at: 180°C <input checked="" type="checkbox"/> fan oven 200°C <input type="checkbox"/> conventional oven		Approximate cooking time (preheated oven)
Beef	Rare	20 minutes per 450g (1lb) plus 20 minutes
	Medium	25 minutes per 450g (1lb) plus 25 minutes
	Well done	30 minutes per 450g (1lb) plus 30 minutes
Lamb	Medium	25 minutes per 450g (1lb) plus 25 minutes
	Well done	30 minutes per 450g (1lb) plus 30 minutes
Pork		35 minutes per 450g (1lb) plus 35 minutes
Poultry		20 minutes per 450g (1lb) plus 20 minutes

Using The Main Oven

Traditional fruit cakes

It should be remembered that ovens can vary over time, therefore cooking times can vary, making it difficult to be precise when baking fruit cakes.

It is necessary therefore, to test the cake before removal from the oven. Use a fine warmed skewer inserted into the centre of the cake. If the skewer comes out clean, then the cake is cooked.

- Do not attempt to make Christmas cakes larger than the oven can cope with, you should allow at least 25mm (1 inch) space between the oven walls and the tin.
- Always follow the temperatures recommended in the **recipe**.
- To protect a very rich fruit cake during cooking, tie 2 layers of brown paper around the tin.
- We recommend that the cake tin is not stood on layers of brown paper, as this can hinder effective circulation of air.
- Do not use soft tub margarine for rich fruit cakes unless the recipe specifically recommends it.
- Always use the correct size and shape of tin for the recipe quantities.

Roast turkey





Roasting turkey involves cooking two different types of meat - the delicate light breast meat, which must not be allowed to dry out, and the darker leg meat, which takes longer to cook.

The turkey must be roasted long enough for the legs to cook, so frequent basting is necessary. The breast meat can be covered once browned.

- Always make sure that the turkey is completely thawed and that the giblets are removed before cooking.
- Turkey should be roasted at *200°C - Conventional / 180°C - Fanned* for 20 minutes per 450g (1lb), plus 20 minutes, unless packaging advises otherwise.
- The turkey can be open roasted, breast side down, for half of the cook time, and then turned over for the remainder of the cooking time.
- If roasting turkey covered with foil, **add** 5 minutes per 450g (1lb) to the cooking time.

To test if the turkey is cooked, push a fine skewer into the thickest part of the thigh. If the juices run clear, the turkey is cooked. If the juices are still pink, the turkey will need longer cooking.

Using the Oven

Oven Function		Temperature °C	Recommended Uses
	Conventional Oven	200 °C	The zones of heat throughout the oven make this function suitable for traditional roasting. Place the meat towards the centre of the oven, roast potatoes towards the top and puddings towards the base.
	Intensive Bake	220 °C	Suitable for foods with a high moisture content such as quiche, cheesecakes and bread. Eliminates the need to blind bake pastry.
	Fanned Oven	180 °C	The even temperature throughout this oven makes this function suitable for batch baking and batch cooking foods.
	Defrost	dEF - no temperature	To defrost frozen foods - use with the oven closed. To cool foods after cooking and prior to refrigeration - use with the door open.

- These functions are all accessed by using the left hand control knob to switch on, select, confirm and switch off.
- The left hand control knob is also used to set the temperature / energy level.

Programmer/Clock

Introduction

This timer may differ from any timer you have used before. Please read through these instructions carefully, and familiarise yourself with the timer, before you start to use it, this will ensure that it is set up correctly.

The timer must show the correct time of day if you want to make the most of it's features, so please make sure that this is done first of all.

The centre knob controls all of the timer functions.

Tips and hints

In order to achieve the best results possible, we recommend:

- Using the minute minder whenever you leave food items in the oven unattended for any length of time.
- When using the automatic functions for the first time, it is recommended that you remain in the house, to make sure that the timings and settings are correct.
- Select foods which are as fresh as possible, and as cold as possible - ie; preferably straight from the refrigerator when automatic cooking.
- Choose foods which are suitable for cooking from a cold start, as some dishes will be affected by being left uncooked, at room temperature, perhaps for several hours, especially when the weather is hot.
- Make sure that meat, poultry and uncooked food are thoroughly thawed before placing them in the oven.
- Cover dishes with lids or foil, as they may be left standing in the oven for some time before cooking.
- Never place warm food in the oven for delayed cooking - eg; stews prepared by frying meat first must be thoroughly cooled before placing in the oven.
- Do not cook dishes containing left over cooked meat or poultry, or pastry dishes with wet fillings, as they are not suitable for automatic cooking.
- Do not put food items intended for delayed cooking into a warm oven - allow the oven to cool before setting for delayed cooking.
- Do not over-fill dishes containing liquids, as they might boil over.
- Never leave food in the oven to cool slowly after cooking, serve immediately or refrigerate.

Programmer/Clock

Setting the time of day

Note: This is a 24 hour clock.

Ensure that the power is switched on to the appliance.

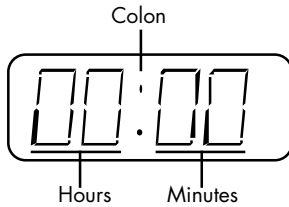

The timer display will show 00.00, and the first two digits (hours) will begin to flash.

This indicates that you should set the hour.



Use the centre control knob to set the correct time, turning the knob clockwise will increase the time and anti clockwise will decrease the time. To confirm the correct hour once you have set it, press the centre control knob to confirm.

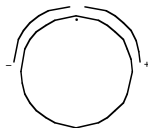

Once the hour has been set, the last two digits (minutes) will begin to flash indicating that they should be set.



Set the minutes passed the hour in the same way as you set the hour.

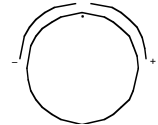

Once the correct minutes are set, press the centre control knob to confirm.

Once the time is set, the colon in the centre will begin to flash regularly, but the time of day will remain lit.

Programmer/Clock

To adjust the time of day

Should you need to adjust the time of day the procedure below should be followed.

Turn the centre control clockwise, and hold for around 5 seconds. You will hear a short audible beep accompanied by the hours digits flashing.

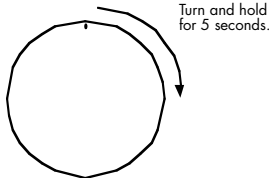

Use the same instructions as detailed on the previous page to adjust the time accordingly.

Setting the minute minder

Press the centre control knob, to access the timer functions. The minute minder is the first function (default).

Press the control knob again. A tone will sound, confirming the minute minder.

The auto programmer indicator will illuminate to confirm that the minute minder is selected. The default number of minutes is 30 but you can adjust the minutes required to a maximum of 99 minutes, or a minimum of

00 minutes by turning the control knob clockwise - to increase the time, or turning it anti-clockwise - to reduce the time.

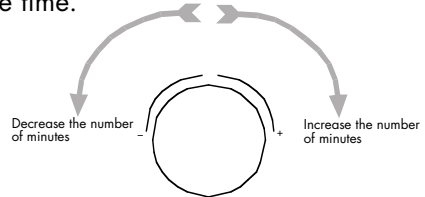

The minute minder will then begin to count down.

Once the countdown has finished, the alarm tone will sound.

To stop the tone sounding press and release the centre control knob. .

Cancelling the minute minder

To cancel the minute minder at any time at all, simply press and release the centre control knob.

Programmer/Clock

Semi Automatic Cooking

Definition: Semi Automatic, alarmed feature with automatic switch off for the main oven functions only, has two different operating modes:-

The duration method - allows you to set the oven for a specific length of time which will countdown before automatically switching off and sounding alarm e.g. If food needs 2 hours to cook, then it is possible for you to set the oven to turn off after 2 hours cook time.

Press centre control knob to initiate timer functions. The minute minder icon will begin flashing.

Select cook time symbol function by rotating centre control knob until the cook time symbol is flashing then confirm selection by pressing centre control knob again.

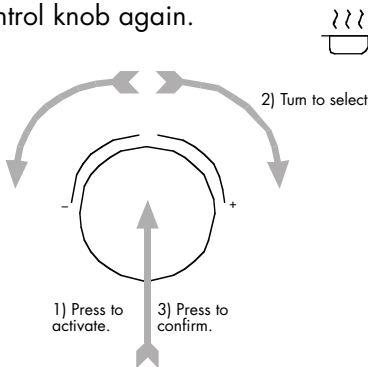

The display will show 00:00 hours with "00".00 flashing.

Enter the hours by rotating the centre control knob clockwise (+) or anti-clockwise (-) to the required hour setting, then confirm by pressing the centre control knob again.

The minutes, 00:"00" will now start to flash, set the minutes in the same way as you set the hours and confirm by pressing the centre control knob

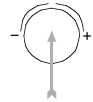

The timer end time icon is now illuminated, however you do not need to enter an end time. Just press the control knob twice to skip past it.



The timer set indicator on the bottom right hand side of the timer display illuminates confirming timer function has been set correctly and will remain illuminated until the program has finished, or it is cancelled.

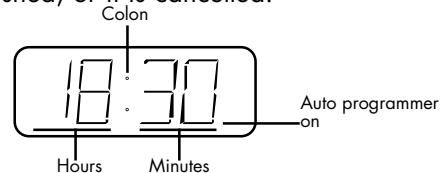

The display will alternate between the time of day, and the remaining cooking time throughout the program.

Once the time has run down, a tone will sound and the appliance will switch itself off.

To Cancel:

Press the centre control knob at any time.

Programmer/Clock

Semi Automatic Cooking (Continued)

End Time method – allows you to set a specific time of day you want the oven to automatically switch off and sound the alarm e.g. if you start cooking food and you wish it to automatically switch off at 16.00hrs, you can program the end time in and the appliance will automatically switch off at this time sounding an alarm.

Press centre control knob to initiate timer functions. The minute minder icon will flash.

Select end time symbol function by rotating centre control knob until end time symbol is flashing, then confirm your selection by pressing centre control knob once.

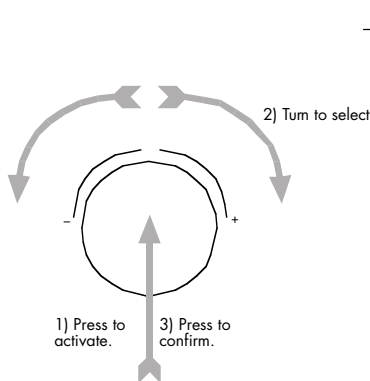

The display will show 00:00 with the "00":00 flashing.
Enter the end time hours by rotating

the centre control knob clockwise (+) or anticlockwise (-) to the required hour setting, then confirm by pressing the centre control knob once.

Always remember that this is a 24 hour clock.

The minutes, 00:"00" will now start to flash - set the minutes past the hour in the same way as you set the hour.

The timer set indicator on the bottom right hand side of the timer display illuminates confirming timer function has been set correctly and will remain illuminated until the program has finished, or it is cancelled.

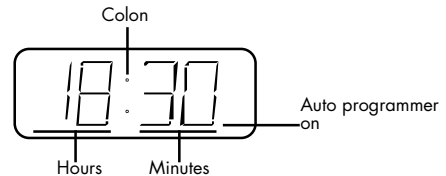

The timer display will alternate between the time of day, and the end cooking time while the program is running.

When end time is reached an alarm will sound and the appliance will switch itself off. To stop the tone sounding - press the centre control knob.

To cancel:

Press the centre control knob at any time.

Programmer/Clock

Fully Automatic Cooking

Definition: Fully automatic cooking allows you to use both end time and duration cooking together. The oven calculates a start time from the duration and end times and automatically turns itself on and off.

Note 1:- The main oven function can be set before or after programming the timer and can be adjusted at any time

Press centre control knob to initiate timer functions. The minute minder icon will flash.

Use the centre control knob to select the cook time icon.

Then press the centre knob to confirm your choice.

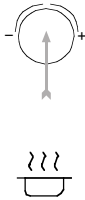

The display will show 00:00 with the hours flashing "00":00.



Enter the cooking duration hours by rotating the centre control knob clockwise (+) or anticlockwise (-) to the required hour setting, then confirm by pressing the centre control knob once.

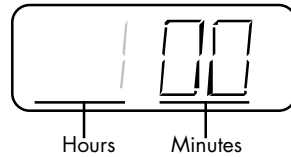

The minutes (00:'00') now start to flash- set the minutes in the same way as you set the hours then press the centre control knob to confirm.

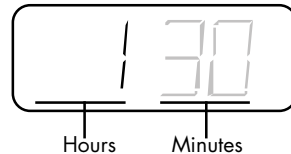

Programmer/Clock

Fully automatic cooking cont'd

The timer end time icon is now illuminated and the timer hours is flashing (‘00’:00). 

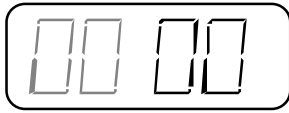

Enter the hour you would like the appliance to turn off at by turning the control knob. Press the centre control knob once, to confirm this.

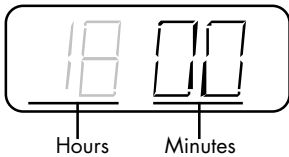

The minutes (00:‘00’) now start to flash. Enter the minutes past the hour in the same way and press the centre control knob to confirm.

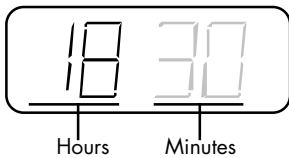

Always remember that this is a 24 hour clock.

The timer set indicator on the bottom right hand side of the timer display illuminates confirming timer function has been set correctly and will remain illuminated until the program has finished, or it is cancelled.

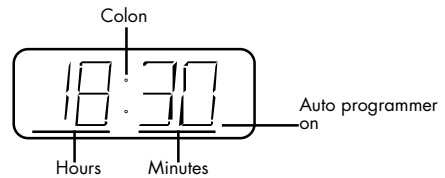

Once the duration and end time have been set, the programmer will work out the start time.

Once the program has finished running, a tone will sound and the appliance will turn itself off. To stop the tone, press the centre control knob.

To cancel:

Press the centre control knob at any time.

Cleaning

Caution: Any cleaning agent used incorrectly may damage the appliance.

Always let the oven cool before cleaning.

Some cooking operations generate considerable amount of grease, this combined with spillage can become a hazard if allowed to accumulate on the oven through lack of cleaning. In extreme cases this may amount to misuse of the appliance and could invalidate your guarantee.

It is recommended that the appliance is cleaned regularly and thoroughly after open roasting.

Do not use caustic, corrosive or abrasive cleaning products, products containing bleach, coarse wire wool or any hard implements, as they will damage the surfaces.

All parts of the appliance can be safely cleaned with a cloth wrung out in hot soapy water.

Do not use steam cleaners on any part of this appliance.

Chrome plated parts

OVEN SHELVES & OVEN SHELF RUNNERS,
GRILL PAN TRIVET

Do not use abrasives or polishes, use a moist soap pad. These items may also be cleaned in a dishwasher.

Note: Oven shelf runners can be removed for cleaning. Grasp the runners, and slide out of the hanging holes as shown.

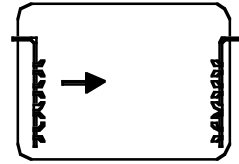

Pristine enamel parts

OVEN CAVITIES, GRILL PAN & ROASTING TINS

We recommend that the appliance is cleaned after open roasting. Use of a trivet in a roasting tin when roasting will help reduce fat splashing.

Use a few drops of washing up liquid in hot water. Wipe the surfaces with a clean cloth wrung out in hot soapy water.

If larger splashes of fat do not readily disappear, use a mild cream cleaner- eg; "Cif".

Stubborn marks may be removed with a moistened soap filled pad e.g: "Brillo".

Cleaning

Glass parts

FACIA PANEL & DOOR PANELS

Use hot soapy water on stubborn marks.

Use a mild cream cleaner - eg; "Cif". Rinse thoroughly and dry with a soft cloth. Do not use abrasive cleaners or polishes.

To remove the glass panel for cleaning, open the door to the door stop position (about 30° open), hold the top and bottom edges of the panel and slide out. Note that if the door is opened fully when removing the inner door glass panel, the door may spring shut.

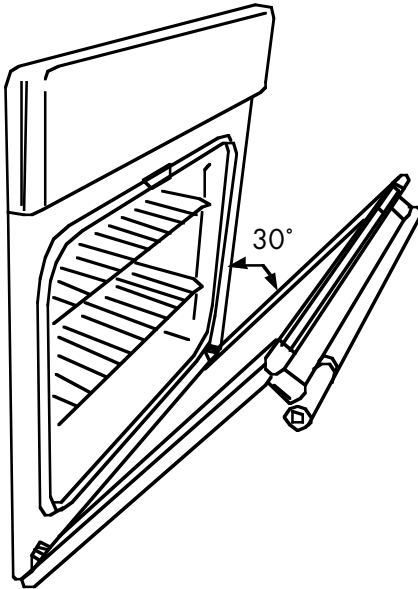

Door stop position

Important: if the inner door glass panel is removed for cleaning, it must be replaced the right way up as shown, and pushed fully in to the stop position.

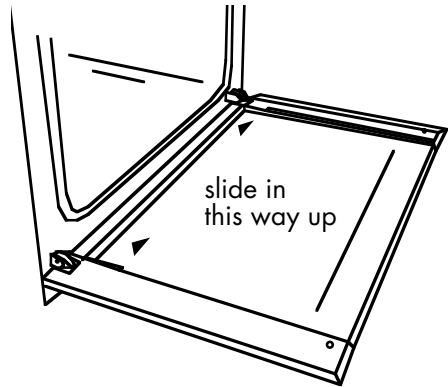

Notes: Glass panels

To meet the relevant Standards of Domestic cooking appliances, all the glass panels on this appliance are toughened to meet the fragmentation requirements of BS3193. This ensures that, in the unlikely event that a panel breaks, it does so into small fragments to minimise the risk of injury.

Please take care when handling, using or cleaning all glass panels as any damage to the surfaces or edges may result in the glass breaking without warning or apparent cause at a later date. Should any glass panel be damaged, we strongly recommend that it is replaced immediately.

Cleaning

Painted, plastic and metal finish parts

DOOR FRAME & HANDLE, CONTROL KNOB

Only use a clean cloth wrung out in hot soapy water.

Stainless Steel surfaces (stainless steel finish models only)

FACIA PANEL, HANDLES, DOOR PANELS

Use a clean cloth wrung out in hot soapy water, and dry with a soft cloth.

Stubborn marks can be removed using a stainless steel cleaner. We recommend that you clean the whole of the stainless steel area to maintain a uniform finish. Supplies can be purchased from Glen Dimplex Cooking Customer Care Centre.

Do not use undiluted bleach or any products containing chlorides as they can permanently damage the steel.

Extra care should be taken when cooking food in salted water. Some foods are corrosive - eg; vinegar, fruit juices and especially **salt** - they can mark or damage stainless steel if they are left on the surface. Turn off and wipe any spillage immediately, taking care to avoid skin contact with any hot surface or spillage.

Sharp objects can mark the surface of stainless steel, but marks will become less noticeable with time.

To maintain the finish of the stainless steel, or to remove any greasy marks, wipe the stainless steel surface sparingly with a *minimum* amount of Baby Oil and kitchen paper.

Do not use cooking oils, as these may contain salt, which can damage the stainless steel surface.

Installation Instructions

Step 1: Prepare installation

Do not lift the oven by the door handle.

Whilst every care is taken to eliminate burrs and raw edges from this product, please take care when handling - we recommend the use of protective gloves during installation.

Please note that the weight of this appliance is approximately **27kg** (unpacked). Take care when lifting it into the housing unit - always use an appropriate method of lifting.

If the appliance is to be installed near to a corner where the adjacent cabinets run at right angles forward of the appliance, there must be a gap of at least 90mm between the appliance and the cabinets, to prevent overheating of the cabinets.

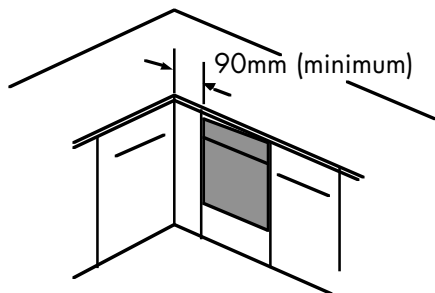

1. Remove the fixing screws from the polythene bag on the top of the appliance, but leave the appliance in the base tray packaging until you are ready to install it.

Note: When removing the appliance from the base tray packaging, care should be taken to ensure the outer frame trim is not damaged.

2. (i) When installed in a typical 600mm deep built in housing unit, the false back should be removed from the housing unit to provide the necessary depth for installation.

(ii) When the false back is removed, it is normally the case that the support shelf for the appliance leaves a gap between the back edge and the wall of approximately 80mm.

(iii) If no gap occurs between the back edge of the shelf unit and the wall behind the unit, we recommend that a gap of at least 30mm is made by shortening the shelf.

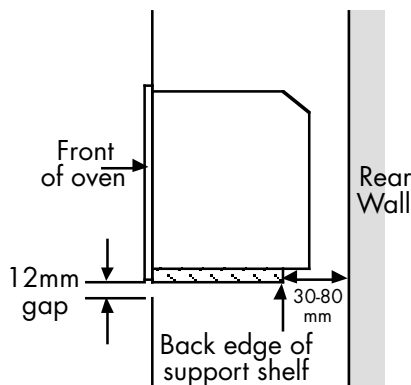

Installation Instructions

The appliance is designed to fit into a standard 600mm wide housing unit, with minimum internal dimensions as shown.

Please note that all dimensions and sizes given are nominal - some variation is to be expected.

590mm is to the underside of the worktop when the appliance is built under. A minimum of 580mm to the underside of the panel above is required when the appliance is installed into a tall housing unit.

Installing the appliance under a worktop

Where the appliance is installed under a worktop, with a hob installed above it, the installation instructions for the hob must be read in conjunction with these instructions.

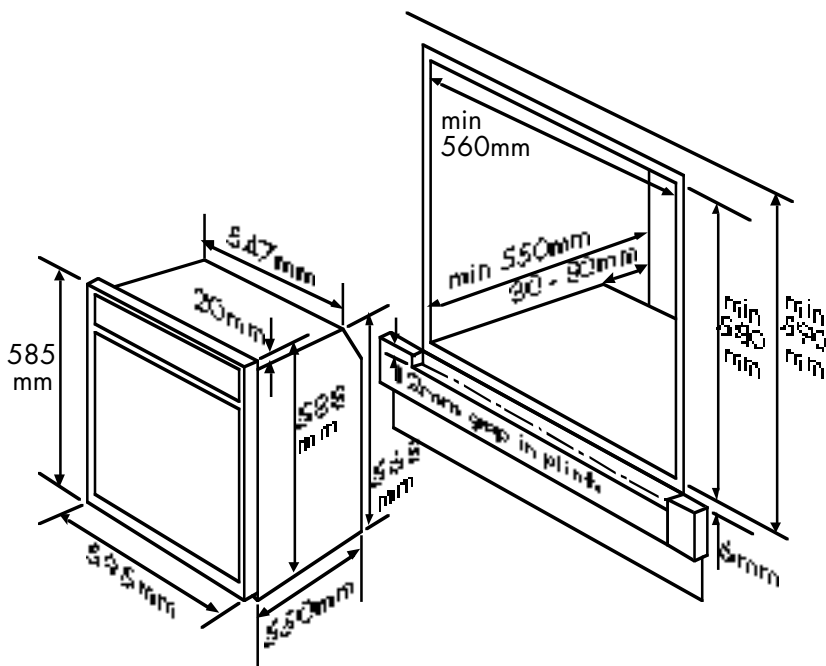

Installation Instructions

Step 2: Check edging strip

The edging strip is factory fitted to the front side edges of the appliance front frame. This strip provides the cabinetry with extra protection from any escape of heat.

When installing the product, ensure that the edging strip is correctly located on the outer edges of the front frame, before positioning and securing the appliance to the cabinet.

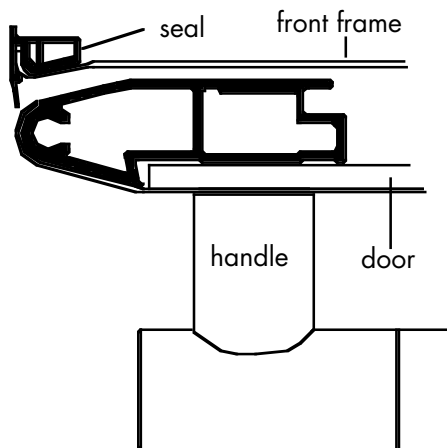

When securing the appliance, the fixing screws provided are driven through the edging strips into the cabinet - the seal will straighten up and sit flush to the cabinet when the screws are fully home.

Step 3: Secure appliance into housing unit

Insert appliance into cabinet and secure - open the oven door and screw 4 screws through the holes in the front frame.

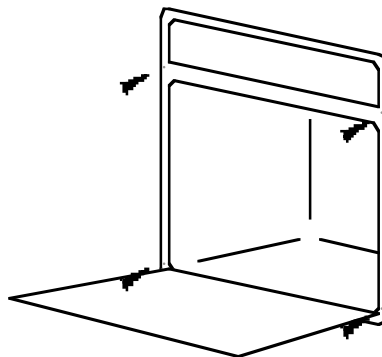

Note: The unit housing the appliance must be appropriately fixed.

Technical Data

Power Supply

220 - 240 V ~ 50 Hz - 2.77kW

Oven lights: 2 x 25W

Connect to the electricity supply

This appliance must be connected by a competent person, using fixed wiring via a double pole switch with a contact separation of at least 3mm in all poles.

We recommend that the appliance is connected by a qualified electrician, who will comply with the I.E.E. and local regulations.

1. Access to the mains terminal is gained by opening the terminal block cover at the rear of the appliance (use a small flat-bladed screwdriver).
2. Connect the cable to the terminal block and tighten the cable clamp cover.
3. Close the terminal box, ensuring that the cover is engaged on the locking tabs.

Warning: This appliance must be earthed.

Stoves Customer Care

In case of difficulty within the UK and Northern Ireland, please call the Stoves Customer Care Centre Helpline on

0870 444 9929

When you dial this number you will hear a recorded message and be given a number of options. This indicates that your call has been accepted and is being held in a queue. Calls are answered in strict rotation as our Customer Care Representatives become available.

Opening Hours for Customer Care Centre

Monday to Friday	8am - 8pm
Saturday	8.30am - 6pm
Sunday	10am - 4pm

Enter appliance numbers here for future reference:

Model No
<input type="text"/> <input type="text"/> <input type="text"/> <input type="text"/> <input type="text"/> <input type="text"/> <input type="text"/> <input type="text"/> <input type="text"/> <input type="text"/> <input type="text"/>
Serial No
<input type="text"/> <input type="text"/> <input type="text"/> <input type="text"/> <input type="text"/> <input type="text"/> <input type="text"/> <input type="text"/> <input type="text"/> <input type="text"/>

Please ensure you have the above details (Model No and Serial No) to hand when calling Stoves Customer Care. They are essential to booking your call.

Outside the UK and Northern Ireland, refer to your local supplier.

STOVES[™]

Stoney Lane, Prescott, Merseyside, L35 2XW