



600GR

600mm Rotostar Gas Oven & Grill

Natural Gas

User & Installation Instructions

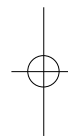
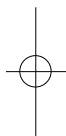

STOVES™

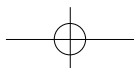

Stoves Customer Care

Thank you for choosing this British built appliance from Stoves. We hope you enjoy many years of trouble free cooking with this oven. Should you need to contact us however, please call the number below and our Customer Care Centre staff will be pleased to help in any way they can.

0151 432 7838

When you dial this number you will hear a recorded message and be given a number of options. This indicates that your call has been accepted and is being held in a queue. Calls are answered in strict rotation as our Customer Care Representatives become available.

Opening Hours for Customer Care Centre

Monday to Friday	8am - 8pm
Saturday	8.30am - 6pm
Sunday	10am - 4pm

When calling please have to hand you appliances model and serial numbers. These numbers help us to quickly identify your product and enable our Customer Care team to provide you with the most up to date advice and support.

Alternatively spares and service call outs can be requested via our website:

www.stoves.co.uk

Outside the UK and Northern Ireland, refer to your local supplier.



CONTENTS

User's Section

Introduction

Be Safe - Not Sorry

Using the Grill

Using the Oven

Programmer / Clock

Cleaning

Micro-computer Operation

Installation Instructions

Fault Finding

Technical Data

Stoves Customer Care

If you smell gas:

Do not try to light any appliance. Do not touch any electrical switch.

Call the Gas Emergency Helpline at TRANSCO on: **0800 111999**

In the Republic of Ireland, call the Bord Gáis emergency line on **1850 205050** or contact your local gas supplier.

Please keep this handbook for future servicing, or for anyone else who may use the appliance.





Your Appliance

600GR fascia detail

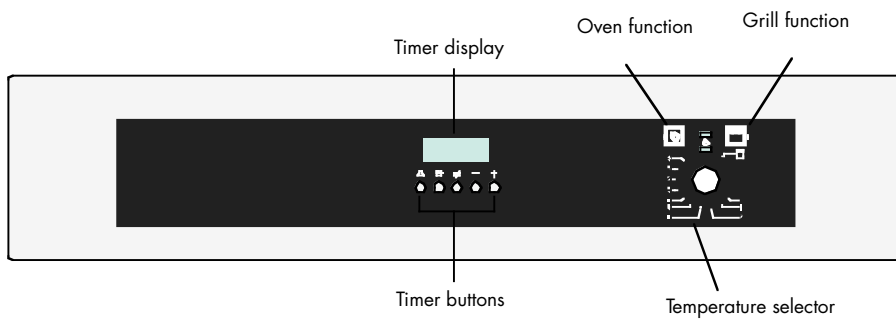

600GR oven detail

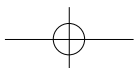
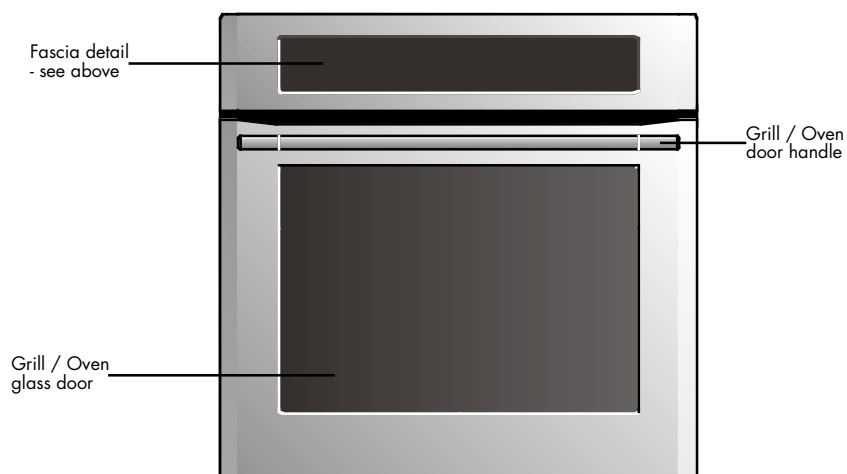

INTRODUCTION

Thank you for choosing a British built appliance by Stoves

We hope the following information will help you to familiarise yourself with the features of the appliance, and to use it successfully and safely.

Our policy is one of constant development and improvement. Strict accuracy of illustrations and specifications is not guaranteed. Modification to design and materials may be necessary subsequent to publication.

This appliance must be installed in accordance with the regulations in force, and only in a well ventilated space. Read the instructions before using or installing this appliance.

Your first year guarantee

To fulfil the conditions of your guarantee, this appliance must be correctly installed and operated, in accordance with these instructions, and only be used for normal domestic purposes.

Please note that the guarantee, and Service availability, only apply to the UK and Republic of Ireland.

The appliance is designed to fit into a standard 600mm wide housing unit with a minimum internal height of 580mm and clear depth of 550mm.

Before using the oven or grill for the first time, remove any protective polythene film and wash the oven shelves and shelf runners in hot soapy water to remove their protective covering of oil. Even so, when you first switch on the oven or grill, you may notice a smell or some smoke.

Glass door panels

To meet the relevant Standards of Domestic cooking appliances, all the glass panels on this appliance are toughened to meet the fragmentation requirements of BS3193. This ensures that, in the unlikely event that a panel breaks, it does so into small fragments to minimise the risk of injury.

Please take care when handling, using or cleaning all glass panels as any damage to the surfaces or edges may result in the glass breaking without warning or apparent cause at a later date. Should any glass panel be damaged, we strongly recommend that it is replaced immediately.

INTRODUCTION

Cooling fan

When you switch on the oven or grill you will hear the cooling fan come on. This fan provides air for the burners and keeps the exterior of the appliance cool during cooking, and the appliance will not operate unless the fan is operating.

The fan will continue to operate to cool the appliance for a few minutes after the last control has been switched off. If the fan malfunctions, the appliance will require servicing. Switch off the electricity supply to the appliance.

Warning: Do not use the oven if the fan is not working.

When hot and cold air meet, condensation forms. The outer door is air cooled and the inner door gets hot, so some condensation might form; this is normal and will disappear within 10 - 15 minutes.

During operation, a metallic click may be heard occasionally. This is caused by the gas valve operating and is quite normal.

Note: operating the control knobs

You may find that the control knobs on your new appliance operate or perform differently to those you are used to.

The controls are part of the unique electronic operating system of the appliance and are designed to be extremely responsive and easy to turn.

Gas & Electrical connection

Please refer to installation instructions for the Gas & Electrical Safety Regulations and the Ventilation Requirements.

In your own interest, and that of safety, it is the law that all gas appliances be installed by competent persons, who will ensure that the installation is in accordance with "The Gas Safety (Installation & Use) Regulations", & the "The Gas Safety (Installation & Use) (Amendment) Regulations". Failure to comply with these Regulations is a criminal offence.

Corgi registered installers undertake to work to satisfactory standards.

Disconnection of gas and electric appliances should always be carried out by competent persons.

Warning: This appliance must be earthed.

In the event of a power cut

1. Switch off the electricity to the appliance at the socket.
2. When the power returns, see the 'Programmer / Clock' section to 'Set the time of day'.

The *Gas Consumer Council* (GCC) is an independent organisation which protects the interests of gas users. If you need advice, you will find the telephone number in your local telephone directory under Gas.

INTRODUCTION

To replace an oven light bulb

Switch off the electricity supply to the appliance at the socket, to avoid the risk of electric shock.

Wait until the oven is cool, then remove the oven shelves.

The lens cover on the light can be removed by grasping the lens cover and pulling away from the side of the oven. Unscrew the bulb.

Please note that the oven light bulbs are not covered by guarantee. Replacement bulbs can be bought from any hardware store.

Ventilation

The use of a gas cooking appliance results in the production of heat and moisture in the room in which it is installed. Ensure that the kitchen is well ventilated; keep natural ventilation holes open or install a mechanical ventilation device (mechanical extractor hood).

Prolonged intensive use of the appliance may call for additional ventilation, for example opening of a window, or more effective ventilation, for example increasing the level of mechanical ventilation where present. This appliance is not connected to a products evacuation device. It shall be installed and connected in accordance with current installation regulations. Particular attention shall be given to the relevant requirements regarding ventilation.

Environmental Protection

We are committed to protecting the environment and operate an Environmental Management System which complies with current policy.

Disposal of packaging

- All our packaging materials are recyclable and environmentally friendly.
- Please help us to protect our environment by disposing of all packaging in an environmentally friendly manner.
- Please contact your local authority for the nearest recycling centre.

Caution: Packaging materials can pose a risk of suffocation - keep away from children.

Ready light

The green ready light is located in the control knob window, below the oven / grill indicator dial.

The ready light will come on with a steady green light to indicate when the oven / grill has reached a suitable temperature. For best results, pre-heat the oven for 15 minutes.

If the green ready light is flashing, or if the red indicator dial is flashing, refer to "Micro-computer Operation" section.

BE SAFE - NOT SORRY

When you are cooking, keep children away from the vicinity of the appliance.

This product is designed as a domestic cooking appliance for the preparation and cooking of domestic food products, and should not be used for any other purpose.

- Remove all packaging, protective films and oils from the appliance before using for the first time.
 - Make sure you read and understand the instructions before using the appliance.
 - Keep electrical leads short so they do not drape over the appliance or the edge of the worktop.
 - Keep all flammable materials (such as curtains, furnishings & clothing) away from the appliance.
 - Parts of the appliance may be hot during or immediately after use. Allow sufficient time for the appliance to cool after switching off.
 - Switch off the electricity supply before cleaning the appliance.
 - Never use the appliance for heating a room.
 - When opening the appliance door, take care to avoid skin contact with any steam which may escape from the cooking.
 - Do not place items on the oven door when it is open.
 - Do not use the oven with the door inner glass panel removed.
- Do not use foil on oven shelves or allow it to block the oven flue, as this creates a fire hazard, and prevents heat circulation.
 - Using aluminium foil to cover the grill pan, or putting items wrapped in foil under the grill creates a fire hazard.
 - Use oven gloves when removing hot food / dishes from the oven or grill. The oven / grill and utensils will be very hot when in use.
 - When cooking heavy items - eg; turkeys - do not pull the oven shelf out with the item still on the shelf.
 - Switch off the electricity supply before replacing an oven light bulb, to avoid the risk of electric shock.

All installation, servicing and maintenance work should be carried out by a competent person who will comply with current Regulations, Standards and Requirements.

When you have finished cooking check that all controls are in the off position.

As with all gas appliances, it is recommended that your appliance is serviced regularly.

USING THE GRILL

Caution: Accessible parts may be hot when grill is used. Young children should be kept away.

Grill ignition

The door must be open when the grill is used, either fully open or using the door stop position - open the door approximately 170mm and it will hold open.

Turn the control knob clockwise to the grill setting.

There is a short delay before ignition as the cooling fan starts.

Should ignition not take place within 25 seconds, the gas and spark generator will be turned off automatically. To light the grill, turn the control knob off, then back to the grill position.

If the door is closed the grill burner will go out. The grill will re-light when the door is opened again.

To switch off, return the control knob to the "off" position.

Preheating

Always preheat the grill for about 3 minutes for best cooked results. The green indicator will illuminate to indicate that the grill is ready.

Aluminium foil

Never cover the grill pan or trivet with aluminium foil, or allow fat to build up in the grill pan, as this creates a fire hazard.

Using the grill

Push the grill pan towards the back and centre of the shelf to position it under the grill. Variation in grilling performance can be achieved by selecting a higher or lower shelf position.

Always use the top position for fast cooking, toasting and grilling foods such as bacon, sausage or steaks.

For thicker foods such as chops or chicken joint pieces use a middle to low shelf position.

The grill trivet, inside the grill pan, can also be inverted to give a high or low position, or it may be removed.

When you have finished grilling, check that the control knob is in the off position.

USING THE GRILL

Detachable grill pan handle

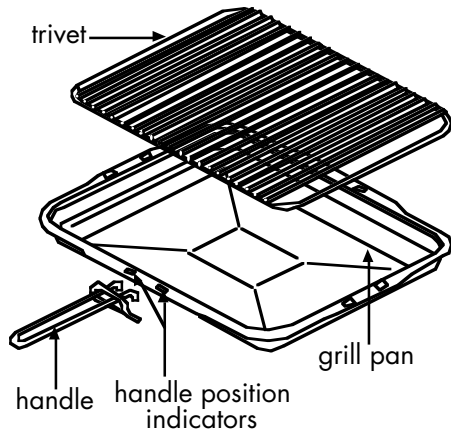

Place the handle over the edge of the grill pan, at the narrow side edges. Slide the handle to the centre, and locate between the handle position indicators.

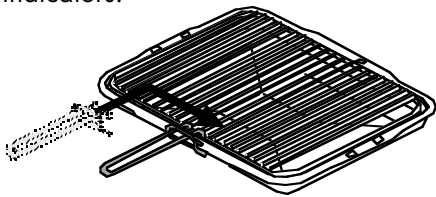

The handle should be removed from the pan during grilling, to prevent overheating.

The handle is designed for removing / inserting the grill pan under the grill when grilling.

If cleaning the grill pan when it is hot, use oven gloves to move it. *Do not* use the handle to pour hot fats from the grill pan.

Food for grilling should be positioned centrally on the trivet.

Notes

- Position the oven shelf on the desired shelf position.
- Position the grill pan centrally on the oven shelf.
- If you choose to grill with the door in the stop position you can remove the grill pan handle by sliding it to the recess.
- The grill cannot be used when the programmer is set for automatic cooking. If 'auto' is showing on the programmer display, you can cancel the 'auto' by pressing the cook time and ready time buttons simultaneously.

USING THE OVEN

Caution: When you are cooking keep children away from the vicinity of the oven.

Manual operation

The oven cannot be used manually when the programmer is set for automatic cooking. If auto is showing on the programmer display, press the cook time and ready time buttons simultaneously to cancel the automatic setting and return to manual operation. The door must be **closed** for the oven burner to ignite. The oven burner will go out when the door is opened but will re-light when the door is closed again, this has no detrimental effect on the food being cooked.

Turn the control knob anticlockwise to the required gas mark setting.

There is a short delay before ignition whilst the cooling fan starts and runs up to speed. The ignition unit will spark for approximately four seconds to light the burner; if ignition does not occur, the computer will close the gas valve for 12 seconds to allow any unburnt gas to disperse, before attempting ignition again. This sequence will occur automatically a further 4 times only. The green lamp will flash if ignition does not occur within 4 attempts. The computer may be reset if ignition has not occurred, by turning the control off then on again to the required setting.

Note: The Rotostar burner will cycle on and off during cooking, maintaining an even temperature, giving greater fuel efficiency.

Warning: do not use the oven if the fan is not working.

Note:

As part of the cooking process, hot air is expelled through a vent at the top of the oven. When opening the oven door, care should be taken to avoid any possible contact with potentially hot air, since this may cause discomfort to people with sensitive skin. We recommend that you hold the underneath of the oven door handle.

Automatic operation

See 'Programmer / Clock' section.

We recommend that 15 minutes is added to the cooking time when using the automatic cooking facility, to allow for preheating.

USING THE OVEN

Oven furniture

Baking tray and roasting tins

For best cooked results and even browning, the maximum size baking trays and roasting tins that should be used are as follows;

Baking tray - 350mm x 280mm.

This size of baking tray will hold up to 16 small cakes.

Roasting tin - 370mm x 320mm

We recommend that you use good quality cookware. Poor quality trays and tins may warp when heated, leading to uneven baking results.

Oven shelves

The oven shelf must be positioned at the rear of the oven with the upstand facing upwards.

Oven lights

Oven lights will come on when the oven is in use.

Programmer / Clock

The Programmer Buttons

- △ minute minder
- ☒ cook time
- ⚡ ready time
- minus
- + plus

To set the "Time of Day"

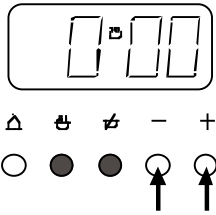

Press the *cook time* and *ready time* buttons simultaneously, and keep the buttons depressed. Use the *plus* and *minus* buttons to set the time of day, eg; 12.00.

A (Auto) symbol goes out, cookpot symbol comes on.

To select an alarm tone

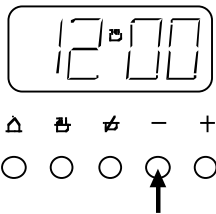

Press the *minus* button to listen to the first tone.

Release the *minus* button and press it again to listen to the second tone, etc.

Releasing the *minus* button after the tone has sounded will automatically select that tone.

Manual operation

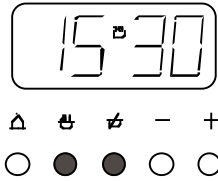

To set the programmer to manual operation at any time (cancelling any automatic setting), press the *cook time* and *ready time* buttons simultaneously. The programmer must be set to manual before the appliance can be used manually.

Setting the minute minder

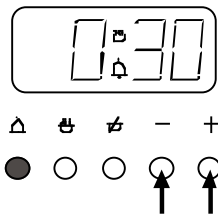

Press the *minute minder* button, then use the *plus* and *minus* buttons to set the required time.

The minute minder (bell) symbol will appear on the display.

You can cancel the minute minder at any time by pressing the *minute minder* button and the *minus* button until the display returns to 0.00.

After setting, the display will revert to show the time of day, but you can press the *minute minder* button, and the display will show the minutes remaining.

The tone will sound at the end of the time set - to cancel the tone, press the minute minder button.

Programmer / Clock

Semi-automatic cooking (example)

You have started cooking a meal or dish in the oven, and want to set the time for the oven to switch off.

Press the *cook time* button, then use the *plus* and *minus* buttons to set the display to show the length of cooking time required, eg; 2 hours as shown **(1)**.

After setting, the display will revert to show the time of day, but you can press the *cook time* button and the display will show how much cooking time still remains on the clock.

Press the *ready time* button, and the display will show the actual time the oven is going to switch off, eg; 18.00 as shown **(2)**.

At the end of the cooking time, the alarm will sound, and the oven will automatically switch off.

To switch off the alarm, press the *minute minder* button **(3)**.

When the oven has switched off, **return the oven control knob to the "off" position**, and press the *cook time* and *ready time* buttons to return to manual operation **(4)**.

If you wish to cancel the automatic setting, or to cancel any remaining cooking time left on the clock before the alarm sounds, press the *cook time* and *ready time* buttons simultaneously. **(4)**.

- 1.** A (Auto) symbol appears.

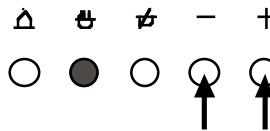

- 2.**

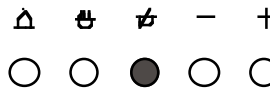

- 3.** A (Auto) symbol will flash.

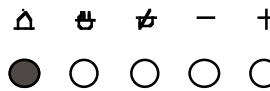

- 4.** A (Auto) symbol goes out.

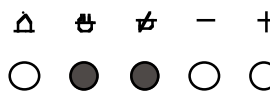

Programmer / Clock

Fully automatic cooking (example)

For use when a delayed start time is required.

You want to set the length of cooking time, and the time for the oven to switch off. The programmer will automatically calculate the cooking start time.

Turn the oven control to the required temperature.

(Oven will begin normal cooking mode.)

Press the *cook time* button, then use the *plus* and *minus* buttons to set the display to show the length of cooking time required, eg; 2 hours as shown **(5)**.

Press the *ready time* button, and the present ready time will be displayed. Using the *plus* and *minus* buttons you can set the display to show the actual time you want the oven to switch off, eg; 18.00 hours (6.00 pm) **(6)**.

The display will revert to show time of day.

The oven will automatically switch on at the calculated start time of 16.00 hours (4.00 pm) **(7)**.

A single press of the *cook time* button shows the cooking time remaining before the oven automatically switches off **(8)**.

- 5.** A (Auto) symbol appears.

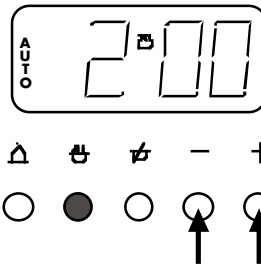

- 6.** The cookpot symbol will disappear from display.

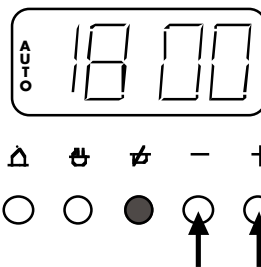

- 7.** The cookpot symbol will appear on display.

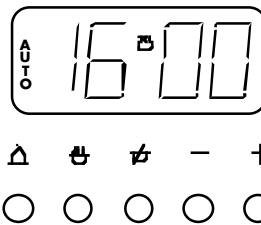

- 8.**

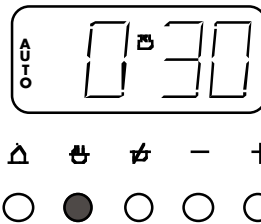

Programmer / Clock

The oven will automatically switch off at 18.00 hours (6.00 pm) and the alarm will sound **(9)**.

9. A (Auto) symbol will flash.

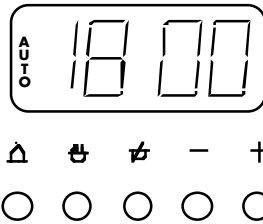

To switch off the alarm press the *minute minder* button **(10)**.

10.

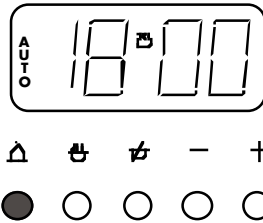

When the oven has switched off, return the oven control knob to the "off" position, and press the *cook time* and *ready time* buttons simultaneously **(11)**.

If you wish to cancel the automatic setting before cooking has started, and return to manual operation, press the *cook time* and *ready time* buttons simultaneously **(11)**.

To cancel any remaining cooking time left on the clock before the alarm sounds, press the *cook time* and *ready time* buttons simultaneously **(11)**.

11. A (Auto) symbol goes out.

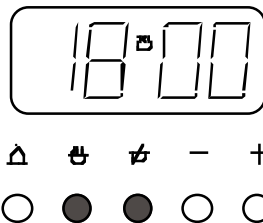

Automatic cooking - hints

Automatic cooking

These notes below are to help you with using the automatic cooking facility. Please make sure that you read them carefully before you start using the automatic functions.

Do

- Familiarise yourself with the use of the programmer.
- Select foods which are as fresh as possible, and as cold as possible - ie; preferably straight from the refrigerator.
- Choose foods which are suitable for cooking from a cold start, as some dishes will be affected by being left uncooked, at room temperature, perhaps for several hours, especially when the weather is hot.
- Make sure that meat, poultry and uncooked food are thoroughly thawed before placing them in the oven.
- Cover dishes with lids or foil, as they may be left standing in the oven for some time before cooking.

Do not

- Never place warm food in the oven for delayed cooking - eg; stews prepared by frying meat first must be thoroughly cooled before placing in the oven.
- Do not cook dishes containing left over cooked meat or poultry, or pastry dishes with wet fillings, as they are not suitable for automatic cooking.
- Do not put food items intended for delayed cooking into a warm oven - allow the oven to cool before setting for delayed cooking.
- Do not over-fill dishes containing liquids, as they might boil over.
- Never leave food in the oven to cool slowly after cooking, serve immediately or refrigerate.

CLEANING

Caution: Any cleaning agent used incorrectly may damage the appliance.

Always let the oven cool before cleaning.

Some cooking operations generate a considerable amount of grease. This, combined with spillage, can become a hazard if allowed to accumulate on the appliance through lack of cleaning. In extreme cases this may amount to misuse of the appliance and could invalidate your guarantee.

It is recommended that the appliance is cleaned after open roasting.

Do not use caustic, corrosive or abrasive cleaning products, products containing bleach, coarse wire wool or any hard implements, as they will damage the surfaces.

All parts of the appliance can be safely cleaned with a cloth wrung out in hot soapy water.

Chrome plated parts

OVEN SHELVES & OVEN SHELF RUNNERS,
GRILL PAN TRIVET

Do not use abrasives or polishes. Use a moist soap pad. These items may also be cleaned in a dishwasher.

Note: Oven shelf runners can be removed for cleaning. Grasp the runners, and slide out of the hanging holes as shown.

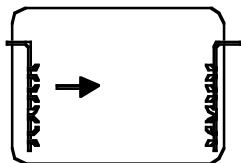

Painted, plastic & metal finish parts

DOOR HANDLE, CONTROL KNOBS

Only use a clean cloth wrung out in hot soapy water.

Enamel surfaces

OVEN CAVITY, ROASTING TIN & GRILL PAN

We recommend that the appliance is cleaned after open roasting, and also after roasting at temperatures higher than gas mark 5. Use of a trivet in a roasting tin when roasting will help reduce fat splashing.

Caution: Most types of cleaning agent will damage these surfaces.

Only use a few drops of washing up liquid in hot water. Wipe the surfaces with a clean cloth wrung out in hot soapy water - if larger splashes of fat do not readily disappear, scrub the area with a nylon brush or nylon pan scourer and hot soapy water. Rinse well and heat the oven to dry the surfaces.

CLEANING

Glass parts

FACIA PANEL & DOOR PANELS

Use a mild cream cleaner. Rinse thoroughly and dry with a soft cloth. Do not use abrasive cleaners or polishes.

To remove the glass panel for cleaning, open the door to the door stop position (about 30° open), hold the top and bottom edges of the panel and slide out. Note that if the door is opened fully when removing the inner door glass panel, the door may spring shut.

Important: if the inner door glass panel is removed for cleaning, it must be replaced the right way up as shown, and pushed fully in to the stop position.

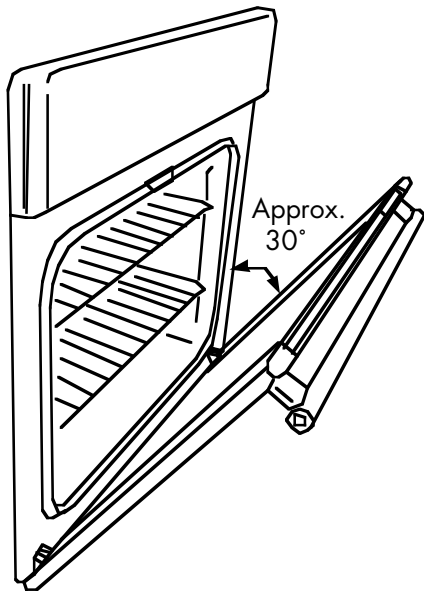

Door stop position

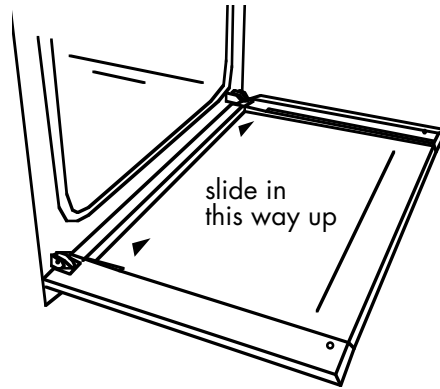

CLEANING

Stainless Steel surfaces (stainless steel finish models only)

FACIA PANEL, HANDLES, DOOR PANELS

Only use a clean cloth wrung out in hot soapy water, and dry with a soft cloth.

Stubborn marks can be removed using stainless steel cleaner. We recommend that you clean the whole of the stainless steel area to maintain a uniform finish. Supplies can be purchased from the Customer Care Centre.

Do not use undiluted bleach or any products containing chlorides as they can permanently damage the steel.

Extra care should be taken when cooking food in salted water. Some foods are corrosive - eg; vinegar, fruit juices and especially **salt** - they can mark or damage stainless steel if they are left on the surface. Turn off and wipe any spillage immediately, taking care to avoid skin contact with any hot surface or spillage.

Sharp objects can mark the surface of stainless steel, but marks will become less noticeable with time.

To maintain the finish of the stainless steel, or to remove any greasy marks, wipe the stainless steel surface sparingly with a minimum amount of baby oil and kitchen paper.

Do not use cooking oils, as these may contain salt, which can damage the stainless steel surface.

MICRO-COMPUTER OPERATION

Lamp state	Cause	Action
Steady green	Oven / grill has reached required temperature.	None - normal operation.
Flashing green	Soft lockout	Reset - turn control knob off / on.
Green ready light / red indicator dial flashing alternately	Hard lockout (possible interference)	Reset - turn off / on at mains. If recurring, a service visit may be required.
Red indicator dial & green ready light flashing together	Fault on micro-computer	Service visit required.

If in doubt, isolate the appliance from the gas and electrical supplies & contact Customer Care.

The 600GR oven grill unit uses a built in micro-computer to control the oven temperature. The computer also indicates when the oven and grill are ready for use, and oversees the gas supply, fan operation and ignition sequence ensuring that these are operating safely.

Should the micro-computer find any fault in the systems under its control, it will either;

- stop the ignition and gas valve operation or;
- if the cooker is already in use it will shut down the operation until the fault is rectified.

The cooling fan will however continue to run, and the oven lights remain on.

Note:

Electrical interference either from the mains or other electrical equipment may cause the computer to indicate a fault when non exists, chiefly when first turning on.

It may be necessary to reset the micro-computer (by turning the electricity supply off at the mains plug) when first bringing the appliance into operation.

In the event of a power cut

1. Switch off the appliance at the socket.
2. When the power returns, see the 'Programmer / Clock section to 'Set the time of day'.

In the event of the gas supply being disconnected it may be necessary to make several lighting attempts before gas reaches the appliance.

INSTALLATION INSTRUCTIONS

Before you start: Please read the instructions. Planning your installation will save you time and effort.

Prior to installation, ensure that the local distribution conditions (nature of the gas and gas pressure) and the adjustment of the appliance are compatible. The adjustment conditions are stated on the data badge.

This appliance is not connected to a combustion evacuation device. It shall be installed and connected in accordance with current installation regulation. Particular attention shall be given to the relevant requirements regarding ventilation.

In your own interest and that of safety, it is the law that all gas appliances be installed and serviced by competent persons. CORGI registered installers undertake to work to satisfactory standards.

Where regulations or standards have been revised since this handbook was printed, always use the latest edition.

In the UK the regulations and standards are as follows:

1. Gas Safety Regulations (Installation and Use).
2. Building Regulations - Issued by the Department of the Environment.
3. Building Standards (Scotland) (Consolidated) - Issued by the Scottish Development Department.
4. The current I.E.E. Wiring Regulations.
5. Electricity at Work Regulations.
6. BS 6172 Installation of Domestic Gas cooking Appliances
Also, for **LP Gas**, refer to BS 5482 Part 1, Part 2 or part 3 as relevant.
7. Installation & Servicing Instructions for this appliance.

For installation in countries other than the UK, the appliance must be connected in accordance with all local gas and electrical regulations. In the Republic of Ireland, Installers should refer to IS813 Domestic Gas Appliances.

Ventilation Requirements

The room containing the appliance should have an air supply in accordance with current regulations:

- All rooms require an openable window, or equivalent, and some rooms will require a permanent vent as well.
- For room volumes up to 5m³ an air vent of 100cm² is required.
- If the room has a door that opens directly to the outside, or the room exceeds 10m³, NO AIR VENT is required.
- For room volumes between 5m³ and 10m³ an air vent of 50cm² is required.
- If there are other fuel burning appliances in the same room, BS 5440: Part 2 should be consulted to determine the air vent requirements.
- This appliance must not be installed in a bed sitting room of less than 20m³ or in a bathroom or shower room.

Windows and permanent vents should therefore not be blocked or removed without first consulting a CORGI gas installer.

LP Gas only - Do not install this appliance in a room below ground level. This does not preclude installation into rooms which are basements with respect to one side of the building, but open to ground level on the opposite side.

In the Republic of Ireland, refer to relevant Irish Standards for correct ventilation requirements.

Failure to install appliances correctly is dangerous and could lead to prosecution.

INSTALLATION INSTRUCTIONS

Step 1: Prepare installation

Do not lift the appliance by the door handle.

Whilst every care is taken to eliminate burrs and raw edges from this product, please take care when handling - we recommend the use of protective gloves during installation.

Please note that the weight of this appliance is approximately **31kg** (unpacked). Take care when lifting it into the housing unit - always use an appropriate method of lifting.

Remove the fixing screws from the polythene bag on the top of the appliance, but leave the appliance in the base tray packaging until you are ready to install it.

If this appliance is to be installed near to a corner where the adjacent cabinets run at right angles forward of the appliance, there must be a gap of at least 90mm between the appliance and the cabinets, to prevent overheating of the cabinets.

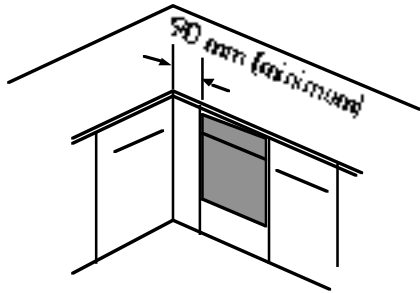

Ensure that the built in unit is appropriately fixed to the wall.

- When installed in a typical 600mm deep built in housing unit, the false back should be removed from the housing unit, to provide the necessary depth for installation.
- When the false back is removed, it is normally the case that the support shelf for the appliance leaves a gap between the back edge of the support shelf and the rear wall of approximately 80mm.
- If no gap occurs between the back edge of the shelf and the wall behind the unit a gap of at least 30mm **MUST** be made by shortening the shelf.
- When fitted below a worktop a gap of 12mm must be made between the top of the plinth and the underside of the support shelf for the appliance.

Important: Do not modify the outer panels of this appliance in any way.

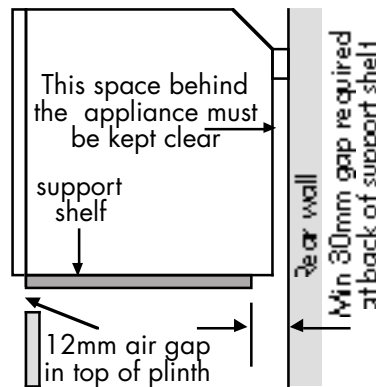

INSTALLATION INSTRUCTIONS

Housing dimensions

The appliance is designed to fit into a standard 600mm wide housing unit with minimum internal dimensions as shown.

591mm is to the underside of the worktop when the appliance is built under, or to the underside of the panel above, when the appliance is installed into a tall housing unit.

Please note that all dimensions are nominal - some variation is to be expected.

Ensure that you route all mains electrical cables and flexible tubing well clear of any adjacent heat source, such as an oven, grill or hob.

Ensure that all pipe work is of the correct rating for both size and temperature.

Installing a hob above the oven

Where the appliance is installed under a worktop, with a hob installed above it, the installation instructions for the hob must be read in conjunction with these instructions.

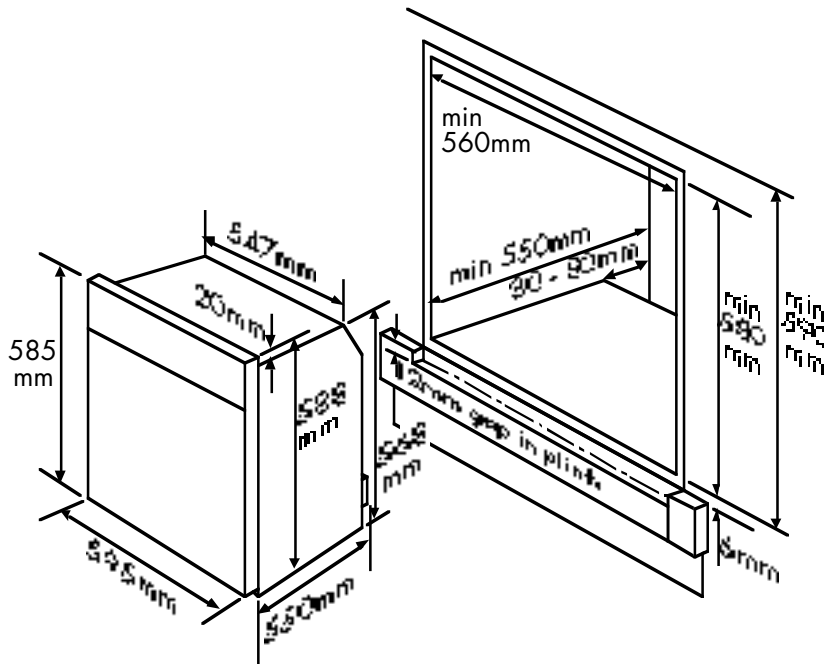

INSTALLATION INSTRUCTIONS

Step 3: Connect to the electricity supply

This appliance must be connected by a competent person, using fixed wiring via a double pole switched fused spur outlet, with a contact separation of 3mm at all poles.

We recommend that the appliance is connected by a qualified electrician, who will comply with the I.E.E. and local regulations.

Warning: This appliance must be earthed.

The wires in the mains lead are coloured in accordance with the following code:

Green & Yellow = earth,

Blue = neutral,

Brown = live.

As the colours of the wires in the mains lead for the appliance may not correspond with the coloured markings identifying the terminals in your spur box, proceed as follows:

1. The wire which is coloured green and yellow must be connected to the terminal marked **E** (Earth)  or coloured green.
2. The wire which is coloured blue must be connected to the terminal marked **N** (Neutral) **LOAD** or coloured Black.
3. The wire which is coloured brown must be connected to the terminal marked **L** (Live) **LOAD** or coloured Red.

If the supply cord is damaged, obtain a special cord from the Customer Support Helpline, which must be fitted by a qualified person.

Typical example of a double pole fused spur outlet

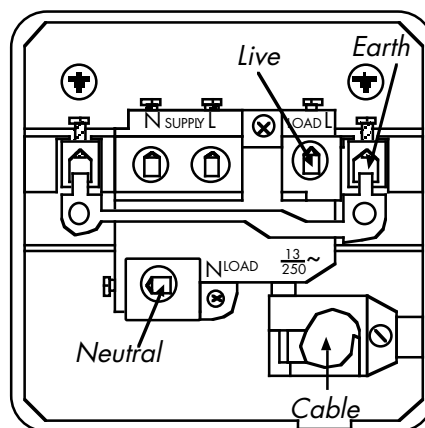
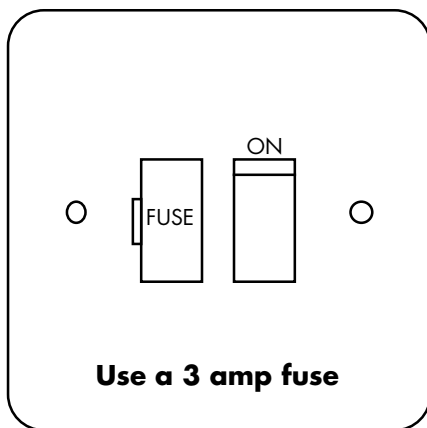

INSTALLATION INSTRUCTIONS

Step 3: Connect to the gas supply

1. The inlet to the appliance is pipe thread ISO RP ½" internal situated at the rear top right corner.
2. Fit the bayonet connection to the wall in the shaded area as shown.

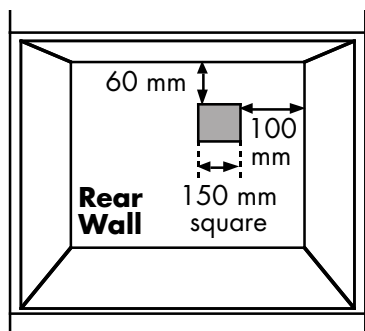

3. Fit the strainer (supplied with the appliance) to the flexible hose inlet as shown, making sure that it is pushed fully into place.

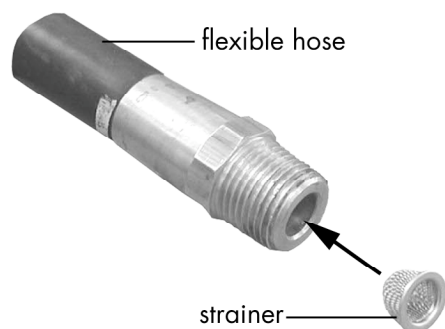

4. Use a 900mm - 1125mm length of flexible connector and make sure it does not block the fan inlet and cannot come into contact with moving parts of the cabinetry - eg; drawers and doors.

5. **Natural Gas** - Flexible connections should be to BS 669. Parts of the appliance likely to come into contact with a flexible connector have a temperature rise less than 70°C.
6. Make sure all connections are gas sound.

Important: - ensure that you route all mains and electrical cables and flexible tubing well clear of any adjacent heat source, such as an oven grill or hob.

Ensure that all pipe work is of the correct rating for both size and temperature.

INSTALLATION INSTRUCTIONS

Step 4: Check edging strip

The edging strip is factory fitted to the front side edges of the appliance front frame. This strip provides the cabinetry with extra protection from any escape of heat.

When installing the product, ensure that the edging strip is correctly located on the outer edges of the front frame, before positioning and securing the appliance to the cabinet.

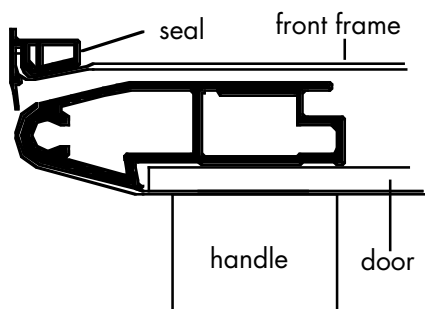

Step 5: Secure appliance into housing unit

Insert appliance into cabinet.

Note: The unit housing the appliance must be appropriately fixed.

To secure the appliance to the housing unit, open the oven door and screw 2 screws through the top corner holes in the front frame.

When securing the appliance, the fixing screws provided are driven through the edging strips into the cabinet - the seal will straighten up and sit flush to the cabinet when the screws are fully home.

INSTALLATION INSTRUCTIONS

Step 5: Commissioning

Burner aeration

All burners have fixed aeration and no adjustment is possible.

Pressure setting

Natural Gas - G20 @ 20 mbar

The pressure test point is on the manifold inlet block.

After setting gas pressure, re-tighten the test point screw, taking care not to over tighten.

Ensure that test point screw is gas sound, using a non-corrosive gas leak detecting fluid.

Programmer

The programmer must be set to manual operation before the oven can be used manually - see the 'Programmer / Clock' section.

Electrical Systems Check

In the event of an electrical fault, the preliminary electrical system check (earth continuity, short circuit, polarity and resistance to earth) must be carried out. There is also a Fault Finding Section in this book.

Grill

1. The door must be open for the grill burner to ignite, either fully open or using the door stop position (open approximately 170mm).
2. Turn the control knob clockwise to the grill setting. **Do not** push in.
3. Close the door and check that the burner goes out. The grill burner will re-ignite when the door is opened again.

Oven

1. Turn the control anticlockwise to the required setting. **Do not** push in.
2. The oven door must be shut for the burner to ignite. The burner will go out when the door is open.

Both oven and grill burners should burn with a red glow with only a small amount of loose flame after a couple of minutes operation.

Before leaving the installation

Show the customer the door stop position for grilling, show them how to ignite the oven and grill and give them this book.

Thank you.

FAULT FINDING

Fault Finding

Method of operation

When the control knob is rotated from the 'OFF' position, a microswitch closes and allows the gas control solenoids to be energised; the same movement of the control rotates an electrical potentiometer.

The micro-computer on the main control board uses the resistance set at the potentiometer to determine the user's requirements - ie; oven or grill and oven temperature asked for.

The oven temperature is sensed by a thermistor in the rear of the oven - the computer compares the electrical resistance of this with that set on the potentiometer and controls the burner accordingly.

Other inputs to the computer are signalled by a door switch, the timer / programmer unit and an air flow checking pressure switch.

The oven fan, cooling fan, and lamps are operated at mains voltage, the solenoid valves, and controls are at 24V. The igniter high voltage coils are mounted on the main PCB.

Upon applying mains voltage, the computer makes a series of checks of the air flow and flame detector before allowing start up.

Electrical faults

These may be either component failure or wiring / connector faults. Should any disconnections be made, it is important that they be re-connected exactly as before or the computer will lock out; poor connections are the most common fault. It is most important that earth wires (green) are all connected and earth screws tight.

There are two forms of micro-computer lockout

Hard lockout (HLO); for instance, air flow failure. This is indicated by the green oven ready light and the red indicator dial flashing. The cooling fan may continue to run for a while. Hard lockout can only be cancelled by turning off the mains electricity supply.

Soft lockout (SLO), for instance, re-ignition failure, will cause the lamp to flash green - the cooling fan may run on, the oven fan will not run on. To cancel soft lockout, turn off the control knob.

Should the oven temperature not reach 40°C within approximately four minutes, the computer will consider that a fault has occurred and go to lockout.

FAULT FINDING

Typical faults assuming all wiring is correct:

Symptom	Fault
HLO on switching On mains	Component fault on main PCB, incorrect wiring
HLO on turning On oven/grill	Fault on control board / potentiometer, incorrect wiring
Oven start up, burner lights and immediately goes out, oven ready light on.	Short circuit thermistor assembly. Note: at room temperature, thermistor resistance is approximately 100k .
Oven fails to ignite, (check that electrode sparks correctly)	<ol style="list-style-type: none"> 1. Incorrectly positioned or open circuit spark electrode (note both grill and oven electrodes must be connected). 2. Faulty solenoid valve. 3. Gas not at appliance. 4. Blocked injector jet.
Oven goes out before set temperature is reached	<ol style="list-style-type: none"> 1. Incorrectly adjusted spark electrode (low flame current). 2. Low gas pressure. 3. Incorrectly positioned potentiometer. 4. If oven goes out after approximately 4 mins, this is due to a disconnected or open circuit thermistor.
Oven fails to re-ignite after set temperature is reached	<ol style="list-style-type: none"> 1. Incorrectly set spark electrode. 2. Low Gas Pressure.
Oven fan fails to start, burner does not light	<ol style="list-style-type: none"> 1. Open circuit in programmer. 2. Component failure on main board 3. Component failure at control board.

FAULT FINDING

Symptom	Fault
Oven fan does not start, oven lamps light	Faulty fan or connections.
Oven fan does not start, lamps do not light	Component failure on main board. Faulty connections.
Cooling fan fails to start 'ON' LED fails to light cooling fan fails to start	<ol style="list-style-type: none"> 1. Faulty fan. 2. Faulty programmer. 3. Faulty component on either board. 4. Faulty mains transformer. 5. Miss set or faulty potentiometer on control board. 6. Faulty transformer or mains supply. 7. Faulty microswitch on control board.
Temperature exceeds set level. Oven goes to HLO after 4 / 5 minutes.	Damaged or disconnected thermistor probe.
Oven fails to operate, green / red lights on steady.	Faulty micro-computer.

Grill faults are generally similar to those listed for the oven.

If the cooling fan starts and runs, the electrodes should spark and the solenoid valves can be heard to open. If the spark electrodes are correctly positioned and no spark occurs, there may be an air detector pressure switch fault, one faulty solenoid valve or no gas supply.

TECHNICAL DATA

Data Badge

Abbreviated data badge located on front frame. Full data badge located on rear panel.

Gas Category

This appliance is factory set for use on either Natural Gas only.
Natural Gas - I₂H (G20 @ 20mbar)

Pressure Test Point

Manifold inlet block

Pressure Setting

Natural Gas - G20 @ 20 mbar

Oven / Grill Light(s)

2 x 25W

Grill Burner

Spark gap 3 - 4mm.

Oven Burner

Rotary surface combustion.
Spark gap 3 - 4mm.

Appliance class

Class 3, Built-In Oven & Grill Unit

Countries of Destination

GB - Great Britain, IE - Ireland

Ignition

Automatic reignition system

Electrical supply

220 - 240V ~ 50Hz, 180W

Burner	Nominal Rate Q _n	Injector size
		Nat Gas G20
Grill	2.8kW	1.28
Main Oven	2.4kW	Amal Size 180
Total Heat Input Σ Q _n	2.8kW	

Stoves Customer Care

Please keep this handbook in a safe place as the information inside may be of use should you sell, or pass on the appliance. Please fill in the model number and serial number in the spaces provided below as they will assist us should you need to call.

0151 432 7838

When you dial this number you will hear a recorded message and be given a number of options. This indicates that your call has been accepted and is being held in a queue. Calls are answered in strict rotation as our Customer Care Representatives become available.

Opening Hours for Customer Care Centre

Monday to Friday	8am - 8pm
Saturday	8.30am - 6pm
Sunday	10am - 4pm

Enter appliance numbers here for future reference:

Model No									
4	4	4							
Serial No									

These numbers can be found on your appliances data badge.
Outside the UK and Northern Ireland, refer to your local supplier.

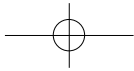
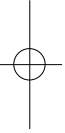

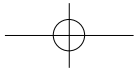
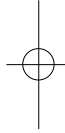
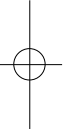

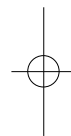
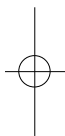

STOVES™

Stoney Lane, Prescott, Merseyside, L35 2XW

08 27006 00 © 1.2004

