

STOVES

Newhome

GL916

900mm built-in gas oven & grill

For Natural Gas models

User & Installation Handbook

If you smell gas:

Do not try to light any appliance. Do not touch any electrical switch.

Call the Gas Emergency Helpline at TRANSCO on: **0800 111999**

In the Republic of Ireland, call the Bord Gáis emergency line on
1850 205050 or contact your local gas supplier.

The Gas Consumer Council (GCC) is an independent organisation which protects the interests of gas users. If you need advice, you will find the telephone number in your local telephone directory under Gas.

The appliance must be installed (and serviced) by a Corgi registered approved installer or a person competent to ensure that the installation is in accordance with "The Gas Safety (Installation and Use) Regulations 1994", and the "The Gas Safety (Installation and Use) (Amendment) Regulations 1996". Failure to comply with these Regulations is a criminal offence.



Contents

User Section.	2 - 22
Introduction	2
Be Safe - Not Sorry.	5
Using the Grill	6
Using the Oven	8
Oven ignition	8
Oven furniture	9
Traditional fruit cakes	10
Roast turkey.	10
Cooking with frozen & chilled foods	11
Slow cooking.	11
Baking guide.	12
Roasting guide.	13
Automatic cooking	14
Programmer / clock	16
Cleaning.	20
Installation Instructions.	23 - 29
Regulations & standards	23
Ventilation requirements.	23
Step 1: Prepare installation	24
Step 2: Connect to electricity supply	26
Step 3: Connect to gas supply	27
Step 4: Check edging strip.	28
Step 5: Secure appliance to housing unit	28
Step 6: Commissioning	29
Technical Data	30
Stoves Customer Care	32

Please keep this handbook for future reference, or for anyone else who may use this appliance.

Introduction

We hope that the following information will help you to familiarise yourself with the features of the appliance, and to use it successfully and safely.

Our policy is one of constant development and improvement. Strict accuracy of illustrations and specifications is not guaranteed. Modification to design and materials may be necessary subsequent to publication.

This appliance must be installed in accordance with the regulations in force and only in a well ventilated space. Read the instructions before using or installing this appliance.

Your 1st Year Guarantee

To fulfil the conditions of your guarantee, this appliance must be correctly installed and operated, in accordance with these instructions, and only be used for normal domestic purposes.

Please note that the guarantee, and Service availability, only apply to the UK and Republic of Ireland.

Before using the appliance for the first time, remove any protective polythene film and wash the oven shelves in hot soapy water to remove their protective covering of oil. Even so, when you first switch on the oven or grill you may notice a smell and some smoke.

Gas & Electrical connection

Please refer to installation instructions for the Gas & Electrical Safety Regulations and the Ventilation Requirements.

In your own interest, and that of safety, it is the law that all gas appliances be installed by a competent person who will ensure that the installation is in accordance with "The Gas Safety (Installation & Use) Regulations 1994", & the "The Gas Safety (Installation & Use) (Amendment) Regulations 1996". Failure to comply with these Regulations is a criminal offence.

Corgi registered installers undertake to work to satisfactory standards.

Disconnection of gas and electric appliances should always be carried out by competent persons.

Warning: This appliance must be earthed.

In the event of a power cut

1. Switch off the electricity to the appliance at the socket.
2. When the power returns, see the 'Programmer / Clock' section to 'Set the time of day'.

Introduction

The cooling fan

The cooling fan helps to keep the exterior cool during normal use. When a burner is operated, you should hear the cooling fan switch on automatically and be able to feel air evacuating from the appliance vents just below the fascia. The cooling fan will continue to operate for approximately 10 minutes after turning off the burners. This is normal. If there is no such indication that the fan is operating, the appliance will require servicing. **DO NOT USE THE APPLIANCE UNTIL IT HAS BEEN SERVICED.** Switch the appliance off at the mains and contact Customer Support.

For your safety

This appliance has a built in safety device to isolate the gas and electric supplies to various components in the event of fan failure.

If the programmer/clock and lights do not function, and the ignition system stops working, the safety device has operated. Within an hour, the safety device will reset itself and the programmer /clock display will flash.

To reset the programmer/clock, simply press and hold in the cook time and ready time buttons, and set the time of day within 5 seconds by pressing the "+" plus and "-" minus buttons.

If when a burner control is turned on, the fan does not operate in the normal way, then the appliance will require servicing. **DO NOT USE THE APPLIANCE UNTIL IT HAS BEEN SERVICED.** Switch the appliance off at the mains and contact Customer Support.

Continued use of the appliance without it being serviced could result in excessive temperatures being generated, which in turn could reduce the life of certain components.

Ventilation

The use of a gas cooking appliance results in the production of heat and moisture in the room in which it is installed. Ensure that the kitchen is well ventilated; keep natural ventilation holes open or install a mechanical ventilation device (mechanical ventilator).

Prolonged intensive use of the appliance may call for additional ventilation, for example opening a window, or more effective ventilation, for example increasing the level of mechanical ventilation where present.

This appliance is not connected to a combustion products evacuation device. It must be installed and connected in accordance with current installation regulations. Particular attention must be given to the relevant regulations regarding ventilation.

Introduction

Glass door panels

To meet the relevant Standards of Domestic cooking appliances, all the glass panels on this appliance are toughened to meet the fragmentation requirements of BS3193. This ensures that, in the unlikely event that a panel breaks, it does so into small fragments to minimise the risk of injury.

Please take care when handling, using or cleaning all glass panels as any damage to the surfaces or edges may result in the glass breaking without warning or apparent cause at a later date. Should any glass panel be damaged, we strongly recommend that it is replaced immediately.

The Gas Consumer Council (GCC) is an independent organisation which protects the interests of gas users. If you need advice, you will find the telephone number in your local telephone directory under Gas.

Condensation

When hot and cold air meet, condensation forms. The outer door is air cooled and the inner door gets hot, so some condensation might form; this is normal and will disappear within 10 - 15 minutes.

To replace a light bulb (if fitted)

Caution: Switch off the electricity supply to the appliance, to avoid the risk of electric shock.

Wait until the oven /grill is cool, then remove the shelves.

Unscrew the lens cover (turn anticlockwise). Unscrew the bulb and replace. Replace lens cover.

Please note that oven light bulbs are not covered by guarantee.

Environmental Protection

Stoves Limited is committed to protecting the environment and operates an Environmental Management System which complies with BS EN ISO 14001:1996.

Disposal of packaging

- All our packaging materials are recyclable and environmentally friendly.
- Please help us to protect our environment by disposing of all packaging in an environmentally friendly manner.
- Please contact your local authority for the nearest recycling centre.

Caution: Packaging materials can pose a risk of suffocation - keep away from children.

Be Safe - Not Sorry

When you are cooking, keep children away from the vicinity of the appliance.

This product is designed as a domestic cooking appliance for the preparation and cooking of domestic food products, and should not be used for any other purpose.

- Remove all packaging from the appliance before using for the first time.
- Make sure you read and understand the instructions before using the appliance.
- Keep electrical leads short so they do not drape over the appliance or the edge of the worktop.
- Keep all flammable materials (such as curtains, furnishings & clothing) away from the appliance.
- Parts of the appliance may be hot during or immediately after use. Allow sufficient time for the appliance to cool after switching off.
- Do not drape tea towels over the flue vents or doors, as this creates a fire hazard.
- Do not use aluminium foil to cover the grill pan, or put items wrapped in foil under the grill, as this creates a fire hazard.
- Never use the appliance for heating a room.
- Do not use the oven with the door inner glass panel removed (glass oven doors only).

- Use oven gloves when removing hot food / dishes from the oven or grill. The oven / grill and utensils will be very hot when in use.
- When opening the appliance door, take care to avoid skin contact with any steam which may escape from the cooking.
- Do not use foil on oven shelves or allow it to block the oven flue, as this creates a fire hazard, and prevents heat circulation.
- When cooking heavy items - eg; turkeys - do not pull the oven shelf out with the item still on the shelf.
- Switch off the electricity supply before replacing the oven light bulb, to avoid the risk of electric shock.
- All installation, servicing and maintenance work must be carried out by a competent person who will comply with current Regulations, Standards and Requirements.
- **Warning:** This appliance must be earthed.
- **When you have finished cooking check that all controls are in the off position.**
- As with all gas appliances, it is recommended that your appliance is serviced regularly.

Using the Grill

Caution: Accessible parts may be hot when the grill is used, young children should be kept away.

Grill ignition

Important: The door must be fully open when the grill is used.

Open the grill door.

Push in and turn the grill control knob anticlockwise to the full-on position.

Adjust to the required setting (there is a turn down to a slightly reduced setting).

Do not operate the grill between the "full on" flame setting and the "off" position.

To switch off, turn the control knob clockwise to return it to the "●" off position.

If for any reason the burner fails to ignite, turn off the control and wait at least one minute before repeating the ignition procedure.

Preheating

Always preheat the grill for a few minutes for best results.

Aluminium foil

Never cover the grill pan or grill trivet with cooking foil, or allow fat to build up in the grill pan, as this creates a fire hazard.

Detachable grill pan handle

Place the handle over the edge of the grill pan. The handle should be removed from the pan during grilling, to prevent overheating.

The handle is designed for removing / inserting the grill pan under the grill when grilling.

If cleaning the grill pan when it is hot, use oven gloves to move it. *Do not* use the handle to pour hot fats from the grill pan.

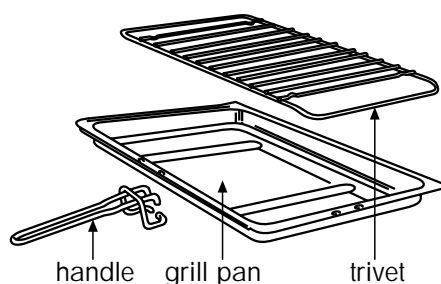

Grill pan trivet

Food for grilling should be placed within the area defined by the kinks in the trivet wires.

Using the Grill

Using the grill

Push the grill pan towards the back of the shelf, to position it under the grill.

Variation in grilling can be achieved by setting the grill between the large and small flame symbols, or by moving the grill pan up or down.

Important: Never operate the grill between the large flame and the off position.

The grill trivet, inside the grill pan, can be inverted to give a high or low position, or it may be removed.

Always use the top shelf position for fast toasting.

When you have finished grilling, check that the control knob is returned to the off position.

Using the Oven

When you are cooking, keep children away from the vicinity of the oven.

Oven ignition

Push in and turn the oven control knob anticlockwise to gas mark 9.

When the oven is switched on the oven light will come on automatically.

It can take up to 60 seconds for the oven burner to come on to full rate, and the oven burner may not come on to full rate unless the oven door is closed.

The automatic ignition will continue to spark for a short time after the burner has lit until the flame is established.

Adjust to the required setting.

To switch off, return the control to the "●" off position

Preheating

The oven must be preheated for 15 minutes when reheating frozen or chilled food, and we recommend preheating for yeast mixtures, batters, soufflés and whisked sponges.

If you are not preheating the oven, the cooking times in the Baking Guide may need to be extended, as they are based on a preheated oven.

Zones of heat

The temperature at the centre of the oven corresponds with the selected gas mark and is slightly higher towards the top of the oven and slightly lower towards the oven base.

These zones of heat can be useful as different dishes requiring different temperatures may be cooked at the same time - eg; the temperature at the oven base is suitable for cooking baked vegetables, baked fruit, milk pudding, etc, and for warming bread rolls, soup, coffee, or ovenproof plates and dishes.

Notes

If it is found over a period of time that the oven becomes hotter when used at a particular gas mark, the thermostat may need to be replaced.

In the event of the burner flames being accidentally extinguished, turn off the burner control and do not attempt to re-ignite the burner for at least one minute.

As part of the cooking process, hot air is expelled through a vent at the top of the oven(s). When opening the oven door, care should be taken to avoid any possible contact with potentially hot air, since this may cause discomfort to people with sensitive skin. We recommend that you hold the underneath of the oven door handle.

Using the Oven

Oven furniture

Baking tray and roasting tins

For best cooked results and even browning, the maximum size baking trays and roasting tins that should be used are as follows;

Baking tray 350mm x 280mm

This size of baking tray will hold up to 20 small cakes.

Roasting tin 370mm x 320mm

We recommend that you use good quality cookware. Poor quality trays and tins may warp when heated, leading to uneven baking results.

Oven shelves

The oven shelf must be positioned with the upstand at the rear of the oven and facing upwards.

Position baking trays and roasting tins on the middle of the shelves, and leave one clear shelf position between shelves, to allow for circulation of heat.

Using the Oven

Traditional fruit cakes

It should be remembered that ovens can vary over time, therefore cooking times can vary, making it difficult to be precise when baking fruit cakes.

It is necessary, therefore, to test the cake before removal from the oven. Use a fine warmed skewer inserted into the centre of the cake. If the skewer comes out clean, then the cake is cooked.

- Do not attempt to make Christmas cakes larger than the oven can cope with; you should allow at least 25mm (1 inch) space between the oven walls and the tin.
- Always follow the temperatures recommended in the recipe.
- To protect a very rich fruit cake during cooking, tie 2 layers of brown paper around the tin.
- We recommend that the cake tin is not stood on layers of brown paper, as this can hinder effective circulation of air.
- Do not use soft tub margarine for rich fruit cakes unless specified in the recipe.
- Always use the correct size and shape of tin for the recipe quantities.

Roast turkey

Roasting turkey perfectly involves cooking two different types of meat - the delicate light breast meat, which must not be allowed to dry out, and the darker leg meat, which takes longer to cook.

The turkey must be roasted long enough for the legs to cook, so frequent basting is necessary. The breast meat can be covered once browned.

- Turkey should be roasted at gas mark 4 for 20 minutes per 1lb, plus 20 minutes unless packaging advises otherwise.
- The turkey can be open roasted, breast side down, for half of the cook time, and then turned over for the remainder of the cooking time.
- If the turkey is stuffed, add 5 minutes per lb to the cooking time.
- If roasting turkey covered with foil, add 5 minutes per 1lb to the cooking time.

To test if the turkey is cooked, push a fine skewer into the thickest part of the thigh. If the juices run clear, the turkey is cooked. If the juices are still pink, the turkey will need longer cooking.

Using the Oven

Cooking frozen & chilled foods

- Preheat the oven.
- When cooking frozen or chilled foods, please follow the manufacturer's instructions. If cooking more than one tray or item, cooking times may need to be increased.
- Please ensure that foods are piping hot before consumption.
- Always use the temperature setting stated on food packaging when cooking convenience food.
- Never overload the tray - eg; oven chips should be placed onto the baking tray in one even layer for satisfactory cooking.
- Follow the cooking times given on packaging but remember they are only intended as a guide and do not take individual preferences into account.
- Always cook frozen convenience foods straight from the freezer unless packaging advises otherwise.

Slow cooking

- Make sure that frozen foods are thoroughly thawed before cooking.
- Do not slow cook joints of meat or poultry weighing more than 2¼kg / 4½lb.
- For roasting joints of meat or poultry and for pot roasts preheat the oven to gas mark 6 and cook for 30 minutes, then adjust the oven control to '**S**' slow set for the remainder of the cooking time.
- Always use the top half of the oven when slow cooking.
- Slow cooking times will be about three times as long as conventional cooking times.

Baking guide - hints

To protect a very rich fruit cake during cooking, stand the tin larger tin or tie 2 layers of brown paper around the tin.

Cooking times for pastry dishes depend on the size and type of cooking dish and also the filling.

When cooking 2 trays of items, remove the top item when it is cooked and raise the lower item to the higher shelf to finish cooking, or where additional browning of the base is required - eg; pies and pastries - interchange part way through cooking.

Using the Oven

Baking guide

Dish	Recommended gas mark	Shelf position	Approximate cooking times
Scones Meringues	7 "S" slow setting	top to middle middle to bottom	8 - 15 mins 2 - 3 hours
Cakes Small cakes Whisked sponge Swiss roll Victoria sandwich (2 x 180mm / 7") Genoese sponge Madeira (180mm / 7") Gingerbread Semi rich fruit cake (205mm / 8") Christmas cake Dundee cake (205mm/8")	5 5 6 4 4 3 3 2 or 3 3	middle to top middle to top middle to top middle to top middle middle to top middle to top middle to top middle to bottom middle to bottom	15 - 25 mins 20 - 25 mins 10 - 12 mins 20 - 30 mins 20 - 30 mins 1 - 1¼ hours 1 - 1¼ hours 2½ - 3 hours depending on recipe 2 - 2½ hours
Pastry Flaky / Puff Shortcrust Choux Plate tarts	7 6 6 6	middle to top middle to top middle to top middle to top	15 - 45 mins 15 - 45 mins 15 - 45 mins 30 - 45 mins
Biscuits Nut brownies Brandy snaps Flapjacks Ginger nuts	6 4 4 4	middle to bottom middle to top middle to top middle to top	15 - 20 mins 7 - 18 mins 20 - 40 mins 10 - 20 mins
Puddings (1 / 2 pint dish) Rice pudding Baked custard Bread and butter Hot soufflé Fruit crumble	2 3 3 4 6	middle to top middle to top middle to top middle to top middle to top	2 - 2½ hours 1 - 1¼ hours ¾ - 1¼ hours 35 - 50 mins ½ - 1 hours

Using the Oven

Roasting guide

The times given in the roasting guide are only approximate, because the size and age of the bird will influence cooking times as will the shape of a joint and the proportion of the bone.

Frozen meat should be thoroughly thawed before cooking. For large joints it is advisable to thaw overnight.

Frozen poultry should be thoroughly thawed before cooking. The time required depends on the size of the bird - eg; a large turkey may take up to 48 hours to thaw.

Use of a trivet with a roasting tin will reduce fat splashing and will help to keep the oven interior clean. Alternatively, to help reduce fat splashing, potatoes or other vegetables can be roasted around the meat / poultry.

Notes;

- When cooking stuffed meat or poultry, calculate the cooking time from the total weight of the meat plus the stuffing.
- For joints cooked in foil or covered roasters, and for lidded casseroles, add 5 minutes per 450g (1 lb) to the calculated cooking time.
- Smaller joints weighing less than 1.25kg (2½lb) may require 5 minutes per 450g (1lb) extra cooking time.
- Position the oven shelf so that the meat or poultry will be in the centre of the oven.
- It is recommended that the appliance is cleaned after open roasting.

Cook in oven at Gas Mark 5		Approximate cooking time (Preheated oven)
Beef	Rare	20 minutes per 450g (1lb), plus 20 minutes
	Medium	25 minutes per 450g (1lb), plus 20 minutes
	Well done	30 minutes per 450g (1lb), plus 30 minutes
Lamb	Medium	25 minutes per 450g (1lb), plus 25 minutes
	Well done	30 minutes per 450g (1lb), plus 30 minutes
Pork		35 minutes per 450g (1lb), plus 35 minutes
Poultry		20 minutes per 450g (1lb), plus 20 minutes

Using the Oven

Automatic cooking

The automatic cooking facility is controlled by the programmer (see 'Programmer/ Clock' section) and allows complete meals, or individual dishes to be cooked while you are out of the house, to be ready for when you return. The '*Ready Time*' should be set as close as possible to, or just after your anticipated return so food is not left standing in a warm oven.

Do:

- Select foods which are as fresh as possible, and as cold as possible - ie; preferably straight from the refrigerator.
- Choose foods which are suitable for cooking from a cold start, as some dishes will be affected by being left uncooked, at room temperature, perhaps for several hours - eg; a wet filling on a pastry base.
- Make sure that meat and poultry are thoroughly thawed (but still cold from the refrigerator), before placing them in the oven, and avoid using rolled joints of meat which can be more susceptible to the growth of food poisoning organisms.
- Cover dishes with lids or foil to keep the food moist, prevent the transfer of odours, and protect from possible contamination; the food can be uncovered towards the end of cooking to crisp and brown.

Do not:

- Warm food should never be placed in the oven if there is a delay period. Stews prepared by frying the meat and vegetables first should be cooked as soon as possible, or refrigerated prior to placing in the oven.
- Some dishes are not suitable for cooking on automatic - eg; dishes containing left over cooked meat or poultry, eggs, cooked rice or seafood.
- Do not put food items (intended for automatic cooking) into a warm oven. Allow the oven to cool before setting for automatic cooking.
- Do not over-fill dishes containing liquids as they might boil over.
- Never leave food in the oven to cool slowly after cooking; serve immediately or refrigerated.
- Never use the automatic facility to reheat 'cook chill' foods as they should go straight from the refrigerator into a preheated oven.

Using the Oven





Important: Food is more susceptible to the growth of food poisoning organisms in warm conditions. If the weather is hot, either take care to ensure that food is not left standing in a warm oven, or avoid using the automatic cooking facility.

Hints for automatic cooking

- Food is placed in a cold oven so you will need to add about 10 - 15 minutes onto the cooking time to allow for the oven to reach the selected temperature.
- Wine or beer may ferment, and cream may curdle during the delay period, so it is best to add these ingredients just before serving.
- Potatoes should be parboiled or brushed with oil to prevent discolouration during the delay period.
- Meat can be brushed with oil to prevent it drying.
- Lemon juice can be added to certain fruits and vegetables such as apples, pears, turnips and parsnips to prevent discolouration during the delay period.

Programmer / Clock

The programmer buttons

-  minute minder
-  cook time
-  ready time
-  manual
- minus
- + plus

To set the time of day

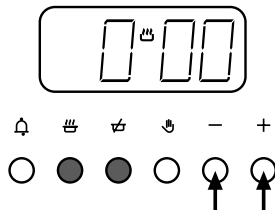

Press the *cook time* and *ready time* buttons simultaneously, and keep them depressed. Use the *plus* and *minus* buttons to set the required time.

Auto symbol goes out. The cookpot symbol comes on.

To select an alarm tone

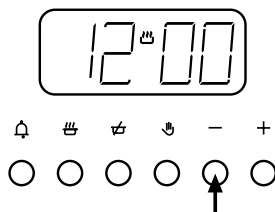

Press the *minus* button to listen to the first tone.

Release the *minus* button and press it again to listen to the second tone etc.

Releasing the *minus* button after the tone has sounded will automatically select that tone.

Manual operation

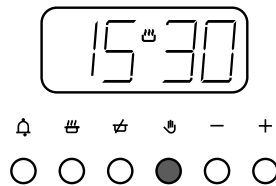

To set the programmer to manual operation at any time (cancelling any automatic setting), press the *manual* button. The programmer **must** be set to manual before the appliance can be used manually.

Setting the minute minder

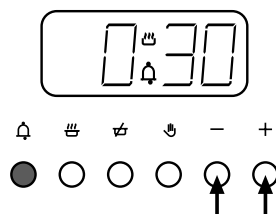

Press the *minute minder* button, then use the *plus* and *minus* buttons to set the required time.

The minute minder symbol will appear on the display.

You can cancel the minute minder at any time by pressing the *minute minder* button and the *minus* button until the display returns to 0.00.

After setting, the display will revert to show the time of day, but you can press the *minute minder* button and the display will show the minutes remaining.

The tone will sound at the end of the time set - to cancel the tone, press the minute minder button.

Programmer / Clock

Semi-automatic cooking (example)

You have started cooking a meal or dish in the oven, and want to set the time for the oven to switch off.

Press the *cook time* button, then use the *plus* and *minus* buttons to set the display to show the length of cooking time required, eg; 2 hours as shown **(1)**.

After setting, the display will revert to show the time of day, but you can press the *cook time* button and the display will show how much cooking time still remains on the clock.

Press the *ready time* button, and the display will show the actual time the oven is going to switch off - eg; 18.00 (6.00 pm) as shown **(2)**.

At the end of the cooking time, the alarm will sound, and the oven will automatically switch off.

To switch off the alarm, press the *minute minder* button **(3)**.

When the oven has switched off, **return the oven knob to the off position**, and press the *manual* button **(4)**.

If you wish to cancel the automatic setting or to cancel any remaining cooking time left on the clock before the alarm sounds, press the *manual* button **(4)**.

1. Auto symbol appears.

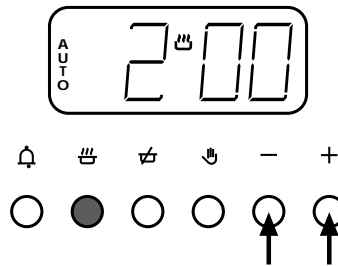

2.

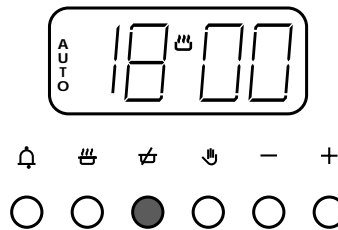

3. Auto symbol will flash.

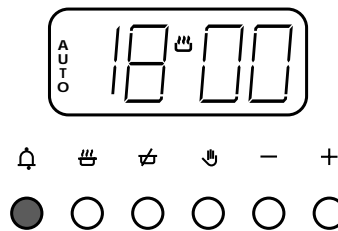

4. Auto symbol goes out.

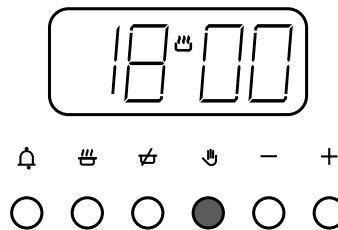

Programmer / Clock

Fully automatic cooking (example)

For use when a delayed start time is required.

You want to set the length of cooking time, and the time for the oven to switch off. The programmer will automatically calculate the cooking start time.

Press the *cook time* button, then use the *plus* and *minus* buttons to set the display to show the length of cooking time required - eg; 2 hours as shown **(5)**.

Press the *ready time* button, and the present ready time will be displayed. Using the *plus* and *minus* buttons you can set the display to show the actual time you want the oven to switch off, eg; 18.00 hours (6.00 pm) **(6)**.

The display will revert to show time of day.

After setting the programmer, turn the oven control to the required temperature.

The oven will automatically switch on at the calculated start time of 16.00 hours (4.00 pm) **(7)**.

A single press of the *cook time* button shows the cooking time remaining before the oven automatically switches off **(8)**.

5. Auto symbol appears.

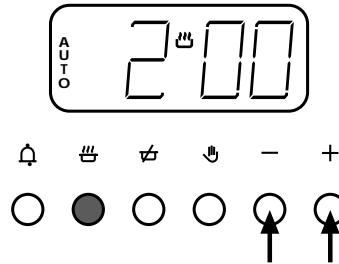

6. The cookpot symbol will disappear from the display.

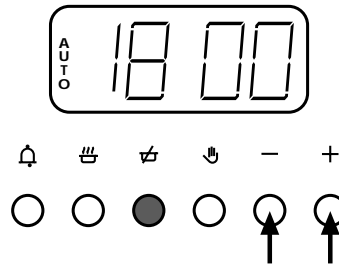

7. The cookpot symbol will appear on the display.

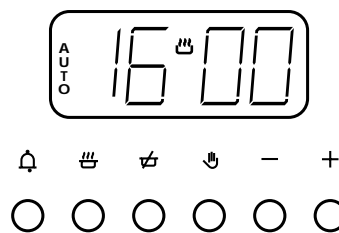

8.

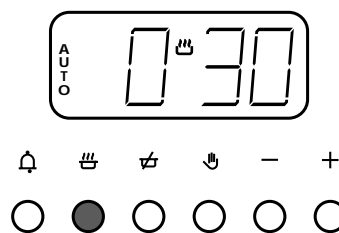

Programmer / Clock

The oven will automatically switch off at 18.00 hours (6.00 pm) and the alarm will sound **(9)**.

9. Auto symbol will flash.

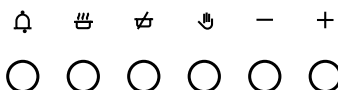

To switch off the alarm press the *minute minder* button **(10)**.

10.

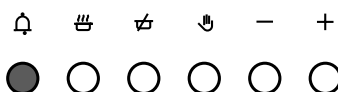

When the oven has switched off, **return the oven knob to the off position**, and press the *manual* button **(11)**.

11. Auto symbol goes out.

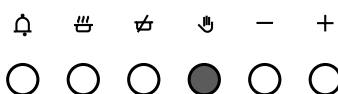

If you wish to cancel the automatic setting before cooking has started, and return to manual operation, press the *manual* button **(11)**. To cancel any remaining cooking time left on the clock before the alarm sounds, press the *manual* button **(11)**.

Cleaning

Caution: Any cleaning agent used incorrectly may damage the appliance.

Always let the appliance cool before cleaning.

Some cooking operations generate a considerable amount of grease. This, combined with spillage, can become a hazard if allowed to accumulate on the appliance through lack of cleaning. In extreme cases this may amount to misuse of the appliance and could invalidate your guarantee.

It is recommended that the appliance is cleaned after open roasting.

Do not use caustic pastes, abrasive cleaning powders, coarse wire wool or any hard implements, as they will damage the surfaces.

All parts of the appliance can be safely cleaned with a cloth wrung out in hot soapy water.

Vitreous enamel parts

GRILL PAN, GRILL COMPARTMENT, OVEN BASE

Use a mild cream cleaner - eg; "Cif".

Stubborn marks may be removed with moistened "Brillo" pad.

The grill pan may be cleaned in a dishwasher, or with a nylon brush in hot soapy water.

Chrome plated parts

OVEN SHELVES & OVEN SHELF RUNNERS, GRILL PAN TRIVET

Do not use abrasives or polishes. Use a moist soap pad - eg; "Brillo".

Shelf runners can be removed for cleaning. Grasp the runners, and slide out of the hanging holes as shown.

Note: These items may also be cleaned in a dishwasher.

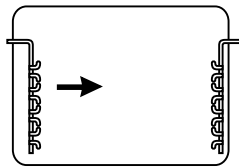

Easy care surfaces (if fitted)

OVEN SIDES AND BACK

If you do a lot of open roasting, or roast at temperatures above 180°C, we recommend regular cleaning to help prevent a build up of fats. Use of a trivet in a roasting tin when roasting will help reduce fat splashing.

Caution: Most types of cleaning agent will damage these surfaces.

Only use a few drops of washing up liquid in hot water. Wipe the surfaces with a clean cloth wrung out in hot soapy water - if larger splashes of fat do not readily disappear, scrub the area with a nylon brush or nylon pan scourer and hot soapy water. Rinse well and heat the oven to dry the surfaces.

Cleaning

Glass parts

FACIA PANEL & DOOR PANELS

Use a mild cream cleaner - eg; "Cif". Rinse thoroughly and dry with a soft cloth. Do not use abrasive cleaners or polishes.

To remove the glass panel for cleaning, open the door to the door stop position (about 30° open), hold the top and bottom edges of the panel and slide out. Note that if the door is opened fully when removing the inner door glass panel, the door may spring shut.

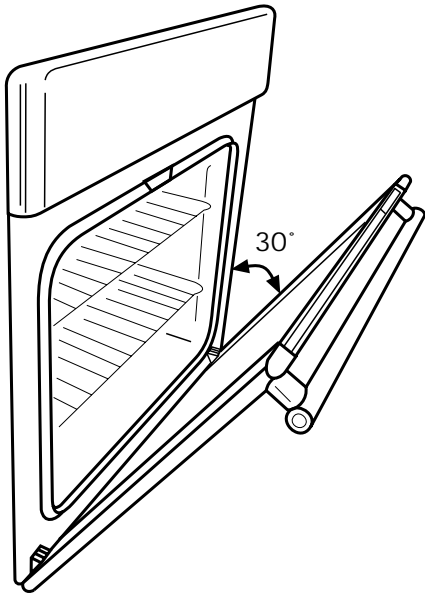

Door stop position

Important: if the inner door glass panel is removed for cleaning, it must be replaced the right way up as shown, and pushed fully in to the stop position.

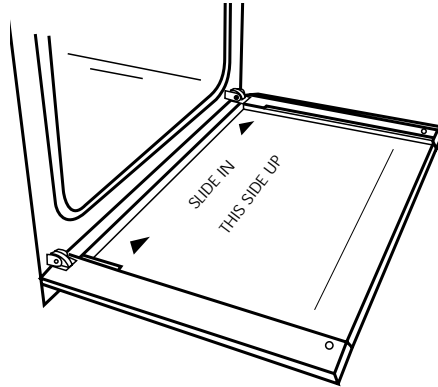

Painted, plastic and metal finish parts (if fitted)

OVEN DOOR FRAME, DOOR HANDLES, OUTER FRAME TRIM, CONTROL KNOBS

Only use a clean cloth wrung out in hot soapy water.

Cleaning

Stainless steel surfaces (stainless steel finish models only)

FACIA PANEL, HANDLES

Only use a clean cloth wrung out in hot soapy water, and dry with a soft cloth.

Stubborn marks can be removed using "Luneta". We recommend that you clean the whole of the stainless steel area to maintain a uniform finish. Supplies can be purchased from H.R.P.C. - contact direct sales order line ☎ 01772 819 672.

Do not use undiluted bleach or any products containing chlorides as they can permanently damage the steel.

Extra care should be taken when cooking food in salted water. Some foods are corrosive - eg; vinegar, fruit juices and especially **salt** - they can mark or damage stainless steel if they are left on the surface. Turn off and wipe any spillage immediately, taking care to avoid skin contact with any hot surface or spillage.

Sharp objects can mark the surface of stainless steel, but marks will become less noticeable with time.

To maintain the finish of the stainless steel, or to remove any greasy marks, wipe the stainless steel surface sparingly with a minimum amount of "Johnson's Baby Oil" and kitchen paper. Do not use cooking oils, as these may contain salt, which can damage the stainless steel surface.

Installation Instructions

Before you start: Please read the instructions. Planning your installation will save you time and effort.

Prior to installation, ensure that the local distribution conditions (nature of the gas and gas pressure) and the adjustment of the appliance are compatible. The adjustment conditions are stated on the data badge.

This appliance is not connected to a combustion evacuation device. It shall be installed and connected in accordance with current installation regulation. Particular attention shall be given to the relevant requirements regarding ventilation.

In your own interest and that of safety, it is the law that all gas appliances be installed and serviced by competent persons. CORGI registered installers undertake to work to satisfactory standards.

Where regulations or standards have been revised since this handbook was printed, always use the latest edition.

In the UK the regulations and standards are as follows:

1. Gas Safety Regulations 1996 (Installation and Use).
2. Building Regulations - Issued by the Department of the Environment.
3. Building Standards (Scotland) (Consolidated) - Issued by the Scottish Development Department.
4. The current I.E.E. Wiring Regulations.
5. Electricity at Work Regulations 1989.
6. BS 6172 Installation of Domestic Gas cooking Appliances
7. Installation & Servicing Instructions for this appliance.

For installation in countries other than the UK, the appliance must be connected in

accordance with all local gas and electrical regulations. In the Republic of Ireland, Installers should refer to IS813 Domestic Gas Installations.

Ventilation Requirements

The room containing the appliance should have an air supply in accordance with BS 5440: Part 2: 1989:

- All rooms require an openable window, or equivalent, and some rooms will require a permanent vent as well.
- For room volumes up to 5m³ an air vent of 100cm² is required.
- If the room has a door that opens directly to the outside, or the room exceeds 10m³, NO AIR VENT is required.
- For room volumes between 5m³ and 10m³ an air vent of 50cm² is required.
- If there are other fuel burning appliances in the same room, BS 5440: Part 2: 1989 should be consulted to determine the air vent requirements.
- This appliance must not be installed in a bed sitting room of less than 20m³ or in a bathroom or shower room.

Windows and permanent vents should therefore not be blocked or removed without first consulting a CORGI gas installer.

In the Republic of Ireland, refer to relevant Irish Standards for correct ventilation requirements.

Failure to install appliances correctly is dangerous and could lead to prosecution.

This appliance is not connected to a combustion products evacuation device. It shall be installed and connected in accordance with current installation regulations. Particular attention shall be given to the relevant requirements regarding ventilation.

INSTALLATION INSTRUCTIONS

Step 1: Prepare installation

Do not lift the appliance by the door handle.

Remove the fixing screws from the polythene bag on the top of the appliance, but leave the appliance in the base tray packaging until you are ready to install it.

Whilst every care is taken to eliminate burrs and raw edges from this appliance, please take care when handling - we recommend the use of protective gloves during installation.

Please note that the weight of this appliance is approximately **48kg** (unpacked). Take care when lifting it into the housing unit - always use an appropriate method of lifting.

Note: When removing the appliance from the base tray packaging care should be taken to ensure the appliance is not damaged.

Siting the appliance

If this appliance is to be installed near to a corner where the adjacent cabinets run at right angles forward of the appliance, there must be a gap of at least 90mm between the appliance and the cabinets, to prevent overheating of the cabinets.

When installed in a typical 600mm deep built in housing unit, the false back should be removed from the housing unit, to provide the necessary depth for installation.

When the false back is removed, it is normally the case that the support shelf for the appliance leaves a gap between the back edge of the support shelf and the rear wall of approximately 80mm.

If no gap occurs between the back edge of the shelf and the wall behind the unit, you must create a gap of at least 30mm by shortening the shelf and any other shelf below the appliance.

Cut 12mm from the top of any plinth that may be fitted (see diagram).

Important: Do not modify the outer panels of this appliance in any way.

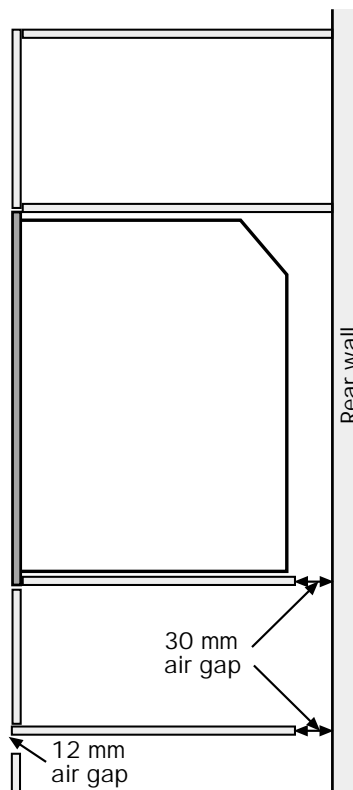

INSTALLATION INSTRUCTIONS

Dimensions

The appliance is designed to fit into a standard 600mm wide housing unit, with minimum internal dimensions as shown.

Note: All sizes are nominal, some variation is to be expected.

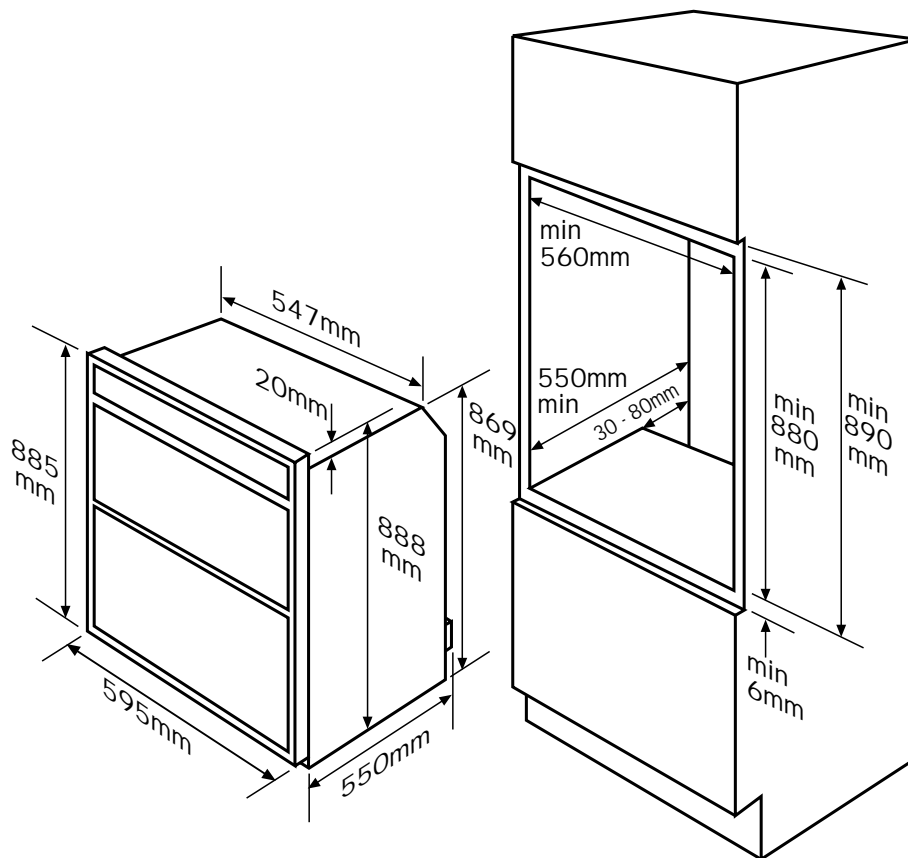

Installation Instructions

Step 2: Connect to the electricity supply

This appliance must be connected by a competent person, using fixed wiring via a double pole switched fused spur outlet, with a contact separation of 3mm at all poles.

Use a 3 amp fuse.

We recommend that the appliance is connected by a qualified electrician, who is a member of the N.I.C.E.I.C. and who will comply with the I.E.E. and local regulations.

Warning: This appliance must be earthed.

The wires in the mains lead are coloured in accordance with the following code:

Green & Yellow = earth,

Blue = neutral,

Brown = live.

As the colours of the wires in the mains lead for the appliance may not correspond with the coloured markings identifying the terminals in your spur box, proceed as follows:

1. The wire which is coloured green and yellow must be connected to the terminal marked **E** (Earth)  or coloured green.
2. The wire which is coloured blue must be connected to the terminal marked **N** (Neutral) **LOAD** or coloured Black.
3. The wire which is coloured brown must be connected to the terminal marked **L** (Live) **LOAD** or coloured Red.

If the supply cord is damaged, obtain a special cord from the Customer Support Helpline, which must be fitted by a qualified person.

Typical example of a double pole fused spur outlet

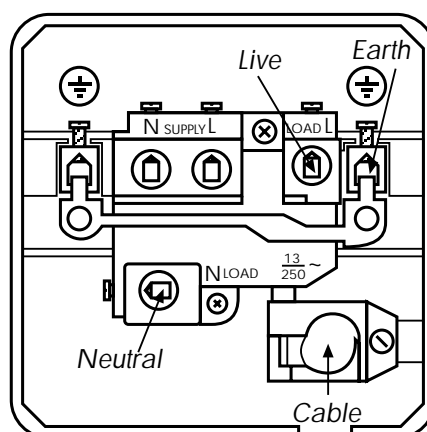
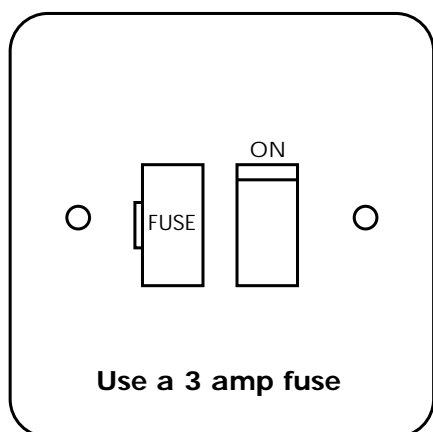

Installation Instructions

Step 3: Connect to gas supply

1. The inlet to the appliance is ISO 7 - Rp 1/2" internal thread situated towards the top right corner of the rear.
2. Fit the bayonet connection to the wall in the shaded area as shown. The shaded area shown is applicable to installations in minimum depth cabinets. If more room is available, the bayonet fixing area can be extended, provided that the flexible tube does not obscure the fan intake.

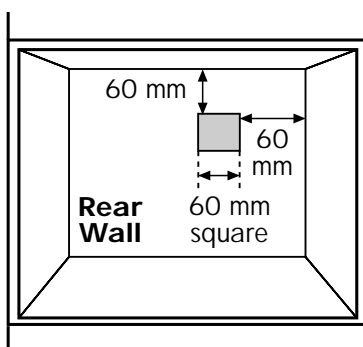

3. Use a 900mm - 1125mm length of flexible connector. The flexible connector shall be fitted such that it cannot come into contact with a moveable part of the housing unit (eg; drawer) and does not pass through any space susceptible of becoming congested. Make sure that the flexible connector does not block the cooling fan inlet.
4. Flexible connections should be to BS 669. Parts of the appliance likely to come into contact with a flexible connector have a temperature rise less than 70°C.
5. Rigid connections must be accessible to disconnect for servicing. Cut a 150mm square hole in the right hand rear corner of the support shelf for the supply pipe.
6. **Make sure all connections are gas sound.**

Installation Instructions

Step 4: Check edging strip

The edging strip is factory fitted to the front side edges of the appliance front frame. This strip provides the cabinetry with extra protection from any escape of heat.

When installing the product, ensure that the edging strip is correctly located on the outer edges of the front frame, before positioning and securing the appliance to the cabinet.

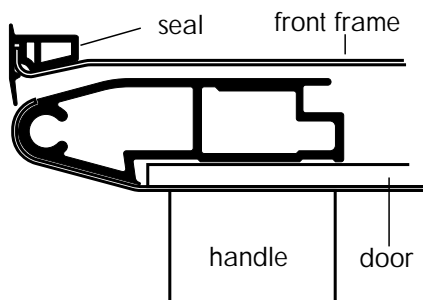

When securing the appliance, the fixing screws provided are driven through the edging strips into the cabinet - the seal will straighten up and sit flush to the cabinet when the screws are fully home.

Step 5: Secure appliance into housing unit

Insert appliance into cabinet.

Note: The unit housing the appliance must be appropriately fixed.

To secure appliance to housing unit

Note: Ensure that the appliance is centrally located.

Take care not to damage the appliance or cabinet.

There are 6 black no 8 x 25mm long chipboard screws for securing appliance to cabinet.

- Open the grill / top oven door, and screw 2 screws through the top corner holes in the front frame.
- With the grill / top oven door still open, screw 2 screws through the holes in the front frame, located under the grill compartment.
- Open the main oven door, and screw the remaining 2 screws through the bottom corner holes in the front frame.

Close the grill / top oven door.

Close the main oven door.

Installation Instructions

Step 6: Commissioning

Pressure test point

Use the oven burner. From inside the oven remove the burner cowl. Remove the small screw at the LHS of the burner cradle. Slide the burner to the left to access the injector. Connect manometer to the injector and turn the grill burner to full on to check pressure. Replace in reverse order.

Burner aeration

All burners have fixed aeration and no adjustment is possible.

Pressure setting

G20 Natural Gas @ 20 mbar

Electrical systems check

In the event of an electrical fault the preliminary electrical system check (earth continuity, short circuit, polarity and resistance to earth) must be carried out.

Ignition

The automatic ignition continues to spark for a short time after the burner has lit until the flame is established.

Oven

1. Push in and turn the control knob anticlockwise to Gas Mark 9. The oven light will come on automatically.
2. Adjust to the required setting.
3. The burner may not come on to a full rate unless the oven door is closed.

The oven burner operates at a low rate for up to 60 seconds until the flame supervision device opens and full gas rate is obtained.

Grill

1. Open the door, push in and turn the control knob anticlockwise to the full on setting.
2. Check condition of flame at low setting.

When you first turn on the oven or grill you may notice a smell and some smoke which comes from the protective coating of oil burning off from some of the parts.

Before leaving the installation

Show the customer how to ignite the oven and grill, and give them this handbook. THANK YOU.

Technical Data

Data badge

Lower part of front frame

Pressure setting

G20 Natural Gas @ 20 mbar (8"wg)

Gas category

Natural gas - I_{2H}

Appliance class

Class 3

Ignition

Mains operated re-ignition generator

Oven light

1 x 25W

Electrical supply

220 - 240V ~ 50Hz, 56W

Grill

Nominal Rate Q_n 2.25kW

Injector 1.12mm

Spark gap 3 - 4mm

Oven

Bray type burner, sheet steel body, stainless steel flame strip

Nominal Rate Q_n 2.5kW

Injector 1.25mm

Spark gap 3 - 4mm

Oven injector - If the injector is removed or replaced for any reason, it is mandatory to apply Hylomar PL32 or Plasticol X10 sparingly to the thread prior to (re)fitting.

Total heat input ΣQ_n 4.75kW

Countries of destination

GB - Great Britain, IE - Ireland

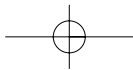
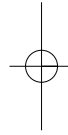
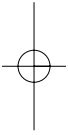

Stoves Customer Care

In case of difficulty within the UK and Northern Ireland, please call the Stoves Customer Care Centre Helpline on

0151 432 7838

When you dial this number you will hear a recorded message and be given a number of options. This indicates that your call has been accepted and is being held in a queue. Calls are answered in strict rotation as our Customer Care Representatives become available.

Opening Hours for Customer Care Centre

Monday to Friday	8am - 8pm
Saturday	8.30am - 6pm
Sunday	10am - 4pm

Enter appliance numbers here for future reference:

Model No
<input type="text"/> <input type="text"/> <input type="text"/> <input type="text"/> <input type="text"/> <input type="text"/> <input type="text"/> <input type="text"/> <input type="text"/>
Serial No
<input type="text"/> <input type="text"/> <input type="text"/> <input type="text"/> <input type="text"/> <input type="text"/> <input type="text"/> <input type="text"/> <input type="text"/>

Please ensure you have the above details (Model No and Serial No) to hand when calling Customer Care. They are essential to booking your call.

Outside the UK and Northern Ireland, refer to your local supplier.

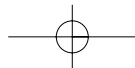
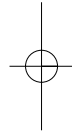
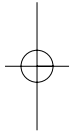

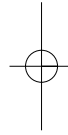
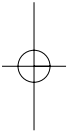

08 25277 00 © 2002
RS2/2

STOVES LIMITED
STONEY LANE, PRESCOT, MERSEYSIDE, L35 2XW

