



STOVESTM

IMPORTANT NOTICE

Please note the cooling fan fitted to this appliance is an integral part of its safety and functionality.

When the appliance is installed care must be taken that the cooling fans performance is not impeded by any objects coming into contact with it. (Installation pipes, leads etc)

Care must also be taken that there is sufficient air flow at the rear of the appliance for the cooling fan to run at its optimum efficiency. (Particularly Built In appliances) See clearance dimensions in the installation section of the booklet.

During use the Appliance must never be disconnected from the Mains supply as this will seriously affect the safety and performance of the appliance, particularly in relation to surface temperatures becoming hot and gas operated parts not working efficiently.

The cooling fan is designed to run on after the control knob has been switched off to keep the front of the appliance and the controls cool until the appliance has naturally cooled itself.

Introduction

Thank you for buying this high quality appliance from us

We would like to congratulate you on choosing this cooker, and hope you find it to be an attractive and beneficial addition to your kitchen. We hope you will enjoy many years of cooking with this appliance, whether you are cooking for yourself, your family or your friends!

This hard working cooker can handle many culinary tasks, leading to ambitious and creative cooking all round.

This handbook is designed to help you through each step of owning your new cooker, from installation, to use.

Please read through all of this guide carefully before you start using your cooker, as we have endeavoured to answer as many questions as possible, and provide you with as much support as we can.

If, however, you should find something missing, or not covered, please contact the Stoves Customer Care team who will be only too happy to assist you on:

0871 22 22 502

In addition you could always try the website for frequently asked questions and more Customer Care information.

In addition, you have also been provided with a card for registering your appliance for it's one year guarantee, and a leaflet for extended warranty.

Our policy is one of constant development and improvement, therefore we cannot guarantee the strict accuracy of all of our illustrations and specifications - changes may have been made subsequent to publishing.

Contents

User's Section	1 - 51
Introduction	1
Specifications	2 - 3
Before using your cooker	4
 Using the Programmer/Clock	 5 - 13
 Using the hob	 14 - 20
Using the hob safely	14
Getting started	15
The fold down lid (if fitted)	16
Your griddle	17
Tips & Hints	18
Care & cleaning	19 - 20
 Your Gas Grill (Richmond models)	 21 - 24
Using the grill safely	21
Getting started	22
General grill information	23
Gas grilling guide	24
 Your Electric Grill (Sterling & Gourmet models)	 25 - 27
Getting started	25
General grill information	26
Electric grilling guide	27
 Your Top Oven (Richmond models)	 28 - 31
Using your top oven safely	28
Getting started	29
Tips & Hints	30
Cleaning the top oven	31
 Your Main Oven(s)	 32 - 35
Using the main oven safely	32
Your conventional ovens	33
Getting started	34
Tips & hints	35

Contents

Guides & Information (all models)	36 - 51
Conventional oven cooking guide	36
General roasting guide (all models)	37 - 39
Slow cook oven	40 - 42
General baking guide	43 - 47
Telescopic shelving system	48 - 49
Cleaning the main oven	50
Cleaning the outside of your cooker	51
Installation Instructions	53 - 61
Clearances	54
Regulations & Requirments	55 - 56
Connecting to the gas supply	57 - 58
Connecting to the electricity	59
Securing your cooker	60
Technical Data	62 - 66
Customer Care	67 - 69
Service record	67
Changing lightbulbs	68
Cook shop	69

Your range appliance

Our range appliances come in the following dimensions:

Width:	Height	Depth:
70cm	90 - 91.5cm	60cm
80cm	90 - 91.5cm	60cm
90cm	90 - 91.5cm	60cm
100cm	90 - 91.5cm	60cm
110cm	90 - 91.5cm	60cm
120cm	90 - 91.5cm	60cm

Please note:

The height of you appliance can only be adjusted if it has adjustable feet.

These measurements are nominal and meant as a guide only.

The specification table:

We have supplied a specification table at the front of this handbook which shows all of the products covered by this guide, please read this carefully as it will identify your appliance and it's features. Please do not worry if some of the sections in this book don't apply to you, just read thoroughly the parts which do.

If you smell gas:

Do not try to light any appliance. Do not touch any electrical switch.

Call the Gas Emergency Helpline at TRANSCO on: **0800 111999**

Specifications

2

	Sterling Contemporary 1000G	Sterling Contemporary 1100G	Richmond Traditional 1000G	Richmond Traditional 1100G
Hob burners: For ratings see Technical Data				
Auxillary	✓	✓	✓	✓
Semi Rapid	✓	✓	✓	✓
Rapid	✓	✓	✓	✓
Wok	✓	✓	✓	✓
Timer:				
Analogue?				
LED/Programmer?	✓	✓	✓	✓
LED/Min. Minder?				
Top oven:				
Grill?			✓	✓
Top oven?			✓	✓
Main oven:				
Grill?	Electric grill	Electric grill		
Conventional?	✓	✓	✓	✓
Fanned?				
Slow cook?	✓ Bottom RHS	✓ Bottom RHS	✓ Bottom RHS	✓ Bottom RHS
Size? (cms)	100	110	100	110
Features:				
Fascia cooling?	✓	✓	✓	✓
Oven lights?	✓	✓	✓	✓
Pristine enamel interior?	✓	✓	✓	✓
Wipeclean interior?				
Cook Clean interior?				
Mains ignition?				
Battery ignition?				
Auto ignition?	✓	✓	✓	✓
Storage compartment?	✓	✓		

Specifications

3

	Gourmet Professional 1100G			
Hob burners: For ratings see Technical Data				
Auxillary	✓			
Semi Rapid	✓			
Rapid	✓			
Wok	✓			
Timer:				
Analogue?				
LED/Programmer?	✓			
LED/Min. Minder?				
Top oven:				
Grill?				
Top oven & Grill?				
Main oven:				
Grill?	Electric grill			
Conventional?	✓ Both ovens			
Fanned?				
Slow cook?				
Size? (cms)	110			
Features:				
Fascia cooling?	✓			
Oven lights?	✓			
Pristine enamel interior?	✓			
Wipeclean interior?				
Cook Clean interior?				
Mains ignition?				
Battery ignition?				
Auto ignition?	✓			
Storage compartment?	✓			



Before using this appliance please make sure that you have removed all packaging and wrapping. Some of the furniture inside this appliance may have additional wrapping.

It is also advised that you turn the ovens and/or grill on for a short while, this will burn off any residues left from manufacturing. There may be a smell which accompanies this process - but this is nothing to worry about and is harmless. We also recommend that you wash the oven shelves, the baking tray, the grill pan, and the grill pan trivet before their first use in hot soapy water, this will remove the protective oil coating.

Although every care has been taken to ensure this appliance has no burrs, or sharp edges, we recommend that you wear protective gloves when installing and moving this appliance. This will prevent any injury.

Before installation we advise that these instructions are read thoroughly, this will allow for preparation and will save time and labour. Always use a registered installer for this appliance as self installation may invalidate your guarantee if done incorrectly.

Introduction

This appliance comes with an automatic programmer and clock. Through your programmer you will be able to set the time of day, set the minute minder, and semi and fully automatically cook. The programmer is vital to the working of your appliance, and reading this section will make sure that you get the most out of your ovens.

The programmer buttons

- minus
- + plus

The 'function' button in the centre is used for setting the minute minder and setting up the automatic cooking. See below for details.

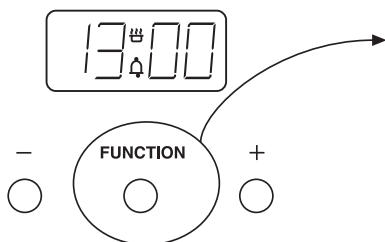

Symbols on the display.

This 'A' symbol appears when either a semi, or fully automatic program is selected. This symbol will flash while a program is being set. Once a program is set the symbol will light up, and remain lit until the alarm sounds, or the program is cancelled

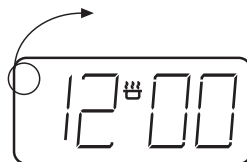

This Bell symbol appears when the Minute Minder function has been selected. While the Minute Minder is being set, the Bell symbol flashes. Once the length of time is set, the Bell symbol remains lit until the time runs down, or the function is cancelled.

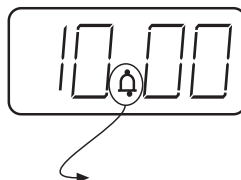

This message and 'A' symbol appear when you are asked to set the length of time you require the oven to cook automatically for. Using the Plus and Minus buttons adjusts this accordingly.



This message and 'A' symbol appear when you are asked to enter in an end time, or when you would like the oven to switch itself off.



Setting the time of day

Before you do anything with your ovens, you must set the correct time of day. This will enable you to make the most of all the ovens functions.

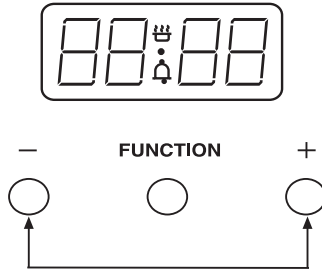

- ◆ Press the Plus and Minus buttons together for a few seconds and release.
- ◆ Set the time of day using the Plus and Minus buttons. Press once for single digit increase, press and hold for rapid increase.
- ◆ Once the time of day has been set wait approx 10 seconds until the '●' stops flashing.
- ◆ Use the appliance as normal.

Setting an alarm tone

There are three tones to chose from.

- Press the minus button to listen to the first tone.
- Release the minus button and press it again to listen to the second tone etc.
- Releasing the minus button after the tone has sounded will automatically select that tone

Setting the minute minder

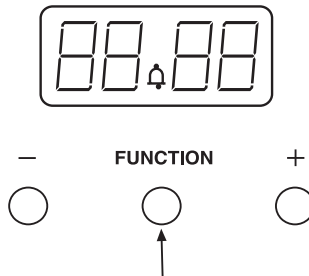

- ◆ To set the Minute Minder, press the Function button once. The bell symbol will appear and start flashing. The flashing only lasts for 5 seconds so the time must be set within this time frame.
- ◆ Use the Plus and Minus button to set the length of time required. Once this has been done, the Minute Minder is set.
- ◆ When the desired length of time has counted down the alarm will sound.
- ◆ To cancel the tone, press any of the buttons.
- ◆ To cancel the Minute Minder at any time, press the Plus and Minus buttons together.

Semi-automatic cooking

There are two types of semi automatic cooking available on this appliance.

The oven must be switched on, and in use to use either of these functions successfully.

- The Duration method allows you to set the oven for a specific length of time.

If a dish needed 2 hours to cook, then it would be possible for you to set the oven to turn off 2 hours later. This allows you to be sure that your food will be cooked for a set length of time and no longer.

- The End Time method allows you to enter a specific time when you would like the oven to switch off.

If you wish to leave the oven unattended, then it offers peace of mind that the oven will have turned itself off at the set time.

However, once the program is set then it cannot be adjusted. Extra time cannot be added, nor can the end time be extended.

To cancel the semi automatic programs, press both the Plus and Minus buttons together. This can be done at any time during the cooking process. Then if necessary, re program.

For the instructions on how to use both of these functions, please see the following page.

Fully automatic cooking

This function incorporates both a duration and an end time and is meant to be used when you wish to delay the start time.

We recommend that the first few times this function is used you are in the house, this will familiarise you with your oven and prevents food from being over, or under cooked.

Care must be taken when selecting foods for this function, it is not recommended for certain food items which may spoil, or are sensitive to being left.

It is also advisable to set the end time to be as close to your return as possible to prevent food being left standing.

Semi - Automatic Cooking

The Duration method

◆ Press the Function button twice, which will skip past the Minute Minder.



◆ The display will flash the word 'dur', and the 'A' will flash on the left hand side of the display.

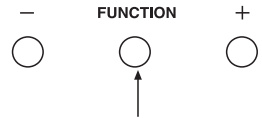

◆ Use the Plus and Minus buttons to set the length of time you want to cook for. This must be done within 5 seconds or the time of day will show again.



Once this is done the oven will automatically switch off once the time has elapsed, and the alarm will sound.

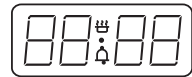

To switch off the alarm, press any button. To view any remaining time press the function button twice.

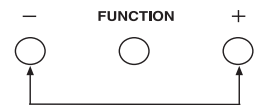

The End Time method

◆ Press the Function button three times, which will skip past the Minute Minder and the Duration programmer.



◆ The display will flash the word 'End' and the 'A' will flash on the left hand side of the display.

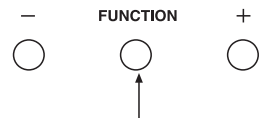

◆ Use the Plus and Minus buttons to select the time the oven is required to turn off.



Once this is done the oven will turn itself off at the time you have selected.



To switch off the alarm, press any button.

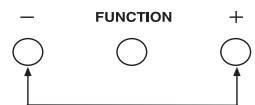

Important: Once the oven has switched itself off please make sure you turn to oven controls to the 'off' position and set the oven to manual by pressing the Cook Time and Ready Time buttons together.

Fully Automatic Cooking (example)

This programming method is best suited for when a delayed start time is required. Unlike the semi automatic methods this requires both the duration and the end time to be entered. The timer will work out the start time and begin cooking.



- ◆ Press the function button twice to select the length of time your food will need.

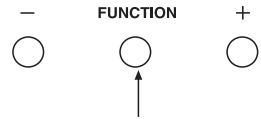

- ◆ The 'A' on the left hand side will flash and the 'dur' message will flash up.



- ◆ Using the Plus and Minus buttons set the time you require within 5 seconds of the 'dur' message.

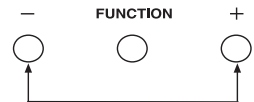
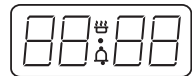

The automatic cooking symbol will appear to show that the oven is no longer in manual mode but in automatic mode.

Fully Automatic Cooking (example)

- ◆ Press the function button three times to select an end time.

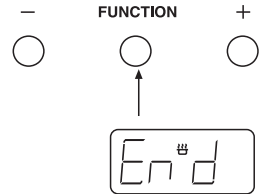

- ◆ The 'End' message will be displayed.

- ◆ Using the Plus and Minus buttons, set the time you would like the oven to switch off.

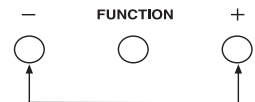
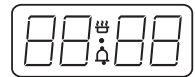

- ◆ Set the temperature of the oven and place the food inside.

While the automatic function is running, the 'A' will appear statically on the display, with the time.

Try to keep the end time as close to when you expect to return, this will prevent cooked food from being left standing in a warm oven. The timer will calculate the appropriate start time.

Important: Once the oven has switched itself off please make sure you turn to oven controls to the 'off' position and set the oven to manual by pressing the Cook Time and Ready Time buttons together.

Automatic cooking

These notes below are to help you with using the automatic cooking facility. Please make sure that you read them carefully before you start using the automatic functions.

Do

- Familiarise yourself with the use of the programmer.
- Select foods which are as fresh as possible, and as cold as possible - ie; preferably straight from the refrigerator.
- Choose foods which are suitable for cooking from a cold start, as some dishes will be affected by being left uncooked, at room temperature, perhaps for several hours, especially when the weather is hot.
- Make sure that meat, poultry and uncooked food are thoroughly thawed before placing them in the oven.
- Cover dishes with lids or foil, as they may be left standing in the oven for some time before cooking.

Do not

- Never place warm food in the oven for delayed cooking - eg; stews prepared by frying meat first must be thoroughly cooled before placing in the oven.
- Do not cook dishes containing left over cooked meat or poultry, or pastry dishes with wet fillings, as they are not suitable for automatic cooking.
- Do not put food items intended for delayed cooking into a warm oven - allow the oven to cool before setting for delayed cooking.
- Do not over-fill dishes containing liquids, as they might boil over.
- Never leave food in the oven to cool slowly after cooking, serve immediately or refrigerate.

Always make sure before you start using the hob that the burner caps, rings and pansupports are correctly placed. This will prevent pans becoming unstable while in use, and ensure an uninterrupted gas flow.

Using the hob safely

- ✓ Always make sure that children are supervised when they are near to the hob when it is turned on.
- ✓ Always ensure that pan bases are dry, and flat based before using them on the hob.
- ✓ Always position pans over the centre of the hotplate, and turn the handles to a safe position so they cannot be knocked or grabbed - failure to do this may lead to accidents and injury.
- ✓ Always use pans which are no smaller than 100mm (4"), or larger than 250mm (10"). Pans which are larger, or smaller than this may result in slower cooking times.
- ✗ Never use double pans, rimbased pans, old or misshapen pans, or any pan which is not stable on a flat surface.
- ✗ Never leave cooking fat, or oil unattended.
- ✗ Never use commercial simmering aids, or heat diffusers, as they create excessive heat and can damage the surface of the hob.
- ✗ Never use the hob for any other purpose than cooking food. This could lead to accidents, and will invalidate any guarantee or warranty you may have taken out.

Getting started

Always make sure the lid (if fitted) on your cooker has been lifted before starting to use the hob, if the lid falls while the hob is in use the SBS will cut off the gas supply - **please do not use this as a method of turning off your appliance.**

Place your pan onto the pansupports above the burner you wish to use.

Push in and turn the control knob for your selected burner, to the full on symbol. The automatic ignition will then light the burner for you - the automatic ignition is activated once you push in the control knob.

Once the flame is established, you can adjust the heat to suit your pan size.

To simmer, turn the control knob to the small flame symbol. This will ensure that the flame is just large enough to gently heat the contents of the pan.

Note: You might hear a slight popping noise while using the hob burners, this is quite normal. However, if anything appears unusual about the appliance i.e. a change in the flame appearance or the operation of the controls - seek expert advice before continuing to use.

Always make sure that your pans are placed correctly on the burners as shown below:

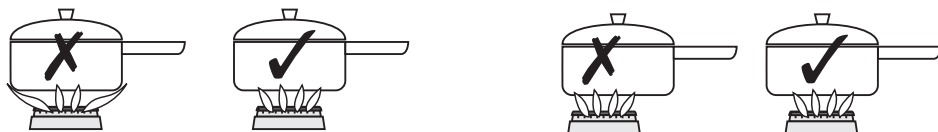

The fold down lid - if fitted

Caution: Glass lids may shatter when heated. Turn off all the burners before shutting the lid.

When opening and closing the lid, use the cooler outer sides of the lid trim.

The lid must be opened fully, so there is no danger of it closing while the hob is being used.

The appliance may be fitted with a switch-back system, which will automatically turn off the hotplate controls if they are inadvertently left on as the lid is closed.

The lid is not intended to be used as a work surface, as it becomes hot when any part of the cooker is in use, and the surface may be scratched if items with rough or sharp surfaces are placed on it.

Caution: **Accessible parts may be hot when the griddle is used. Young children should be kept away.**

The appliance may be supplied with a griddle.

Only use the griddle which has been approved for use on this appliance. Do not use any other griddle, as this may be hazardous.

Please read these instructions thoroughly before using the griddle for the first time.

Refer to the cleaning section for griddle care and cleaning instructions.

Before using the griddle for the first time

Wash the griddle thoroughly in hot soapy water (see “Cleaning” section).

Season sparingly with a minimum amount of cooking oil (see below).

Heat the griddle on full rate for 3 minutes. The griddle plate is now ready for use.

Seasoning the griddle

The griddle is made of quality cast iron, and has a non-stick cooking surface.

Regular seasoning will prolong the life of the griddle and prevent rusting. If the griddle shows signs of rust, wash and re-season.

To season;

- After cleaning, dry the griddle thoroughly.
- Rub the cooking side of the griddle sparingly with a minimum amount of unsalted vegetable oil. Note that olive oil is unsuitable for seasoning.

Using the griddle

The griddle should only be positioned **front-to-back** over the burners indicated by the griddle symbol on the fascia panel.

Do not use the griddle over the large burners.

Place the griddle carefully on the pan support over the burners, using the locating feet on the underside of the griddle. Take care to avoid damage to the surface of the pan supports.

Before cooking, preheat the griddle for 3 minutes on full rate, which is indicated on the control knobs by a large flame symbol.

After preheating, turn the control knobs to the small flame symbol.

The griddle is now ready for cooking.

Do not use metal implements, as they may damage the non-stick surface.

Energy Saving

To save energy:

- Position pans centrally over the burners.
- Only heat the amount of liquid you need.
- Once liquids have been brought to the boil, reduce the heat setting to a simmer.
- Consider using a pressure cooker if possible.
- Vegetables in small pieces will cook quicker.
- Use a pan which is a close match to your burner size.
- Smaller burners are ideal for simmering and stewing in smaller pans, while the larger burners are ideal for frying and boiling.

Choice of pans

Always use flat based pans which are the correct size for your burners, we recommend the following sizes:

100mm or 4" minimum.

250mm or 10" maximum.

Using pans smaller or larger than this may lead to slower cooking times.

Care and Cleaning

In order to keep your hob looking good, and working efficiently, it is important that you make sure it remains clean. Sometimes when a hob is not working well, it is because it needs cleaning.



Important: Always make sure that the hob is totally cooled before cleaning.

Vitreous enamel parts

pansupports, hob spillage wells (enamel models only)

- Use a mild cream cleaner for example 'Cif'. Stubborn marks can be removed with a soap filled pad.

Cast iron parts

griddle, pansupports (if fitted)

- Ensure the griddle or pansupports have fully cooled and scrape off any stubborn marks, and bits of food with a plastic, or wooden cooking implement. Rinse in warm soapy water and dry with a tea towel.
- **Seasoning the griddle:** To season before use, and after cleaning use cooking oil with no added salt. Pour a drop of oil onto the cooking side of the griddle and wipe over with kitchen paper.

Olive oil is not suitable for seasoning. Regular seasoning will prolong the life of the griddle and prevent rusting.

Stainless steel surfaces

hob spillage wells (stainless steel models only)

- Only use a clean cloth wrung out with warm, soapy water and dried off with a soft cloth. For stubborn marks use a specialist stainless steel cleaner.
- **Do not** use undiluted bleaches, or chlorides as these can permanently damage stainless steel. **Do not** use steam cleaners.
- Sharp implements and objects can mark the surface of stainless steel, however they do become less noticeable in time.

To maintain a the finish of stainless steel - use a few drops of Baby Oil on a dry cloth or kitchen towel. Don't use too much, and don't use cooking oil as it might contain salt.

Care & Cleaning (cont'd)



Important: Always make sure that the hob is totally cooled before cleaning.

Burner caps and heads

For the burners to work safely, and efficiently the slots in the burner head when the flames burn should be cleared of deposits.

- Clean with a nylon brush, rinse and then dry thoroughly. There may be brownish coloured markings on your burners, these are carbon deposits or fat stains and can be removed using a soap filled pad.
- **Do not** put burners in the dishwasher or soak them. Using dishwasher powders, washing up liquids and caustic pastes can damage the burners. **Do not** clean with hard implements, wire wool or abrasive cleaning pads.

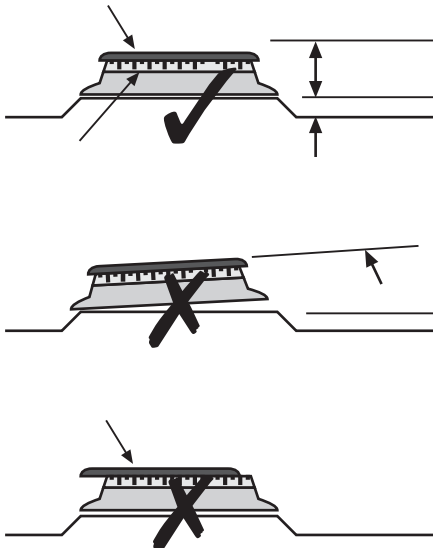

Burner caps and heads must be repositioned correctly so that they sit squarely on to the hob as shown on the the left.

This is particularly important with stainless steel models as failure to reposition the caps correctly may result in discolouration of the stainless steel around the burners.

**Warning: Accessible parts may become hot when the grill is in use.
Children should be kept away.**

- ✓ Always make sure children are supervised if they are near the grill when it is in use.
- ✓ Always grill with the door **open**.
- ✓ Always keep a close eye on the food you are grilling to prevent burning and a potential fire hazard.
- ✓ Always take care when removing food from the grill as the area around the grill may be hot.
- ✓ Always use oven gloves when handling any utensils which have been under the grill as they will be hot.
- ✓ Always use the detachable grill pan handle when sliding the grill pan out from under the grill, and take care not to slide the grill out too quickly.
- ✓ Always make sure that the grill shelf is resting in the correct position in between two runners. Do not place the grill pan on top of the highest runner, this will lead to spillage and injury if the grill pan falls.
- ✗ Do not place items on the the grill door while it is open.
- ✗ Do not wrap foil around the grill shelf, or the grill pan.
- ✗ Do not drape tea towels near the grill while it is on, this will cause a fire hazard.
- ✗ When cleaning the grill pan, please allow it too cool a little. If you wish to empty the grill pan of fat, please use oven gloves and lift the pan, do not use the handle.

The following appliances have a Gas Grill: **Richmond 1000G & 1100G**

Getting started

Before you use the grill, make sure you have placed the grill shelf in the position you need as once the grill is on you may injure yourself if you try and move the shelf while the grill is in use.

Speed of grilling can be adjusted by choosing a high or low shelf setting, and by adjusting the trivet in the grill pan.

Switching on the grill

- Open the oven door and make sure the shelf is where you would like it to be.
- Push in and turn the grill control knob clockwise to the 'on' position. Make sure that the burner is lit before leaving the grill unattended. Do not operate the grill between the 'on' and 'off' settings - use the 'on' setting only.
- If the grill is not lit after 15 seconds, switch off the grill leave the door open and leave for at least one minute before attempting to re light. This will allow any excess gas to disperse.
- Should the burner be extinguished while in use, switch off the grill and again leave for one minute before attempting to re light.
- To turn off, turn the control knob anti-clockwise to the off position.

If the grill door is closed accidentally, the gas will be cut off. The grill will re-ignite upon opening the door. This helps to ensure your safety and is not to be used as a way of turning off the grill.

Important: Do not leave the grill unattended while it is in use.

For best results, pre-heat the grill for about three minutes.

Cooling fan

The grill comes with a cooling fan which is designed to keep the fascia and controls cool while the grill is in use. The fan comes on automatically once the grill is in use and will continue for around 10 minutes after the grill has been switched off. If the cooling fan fails to come on, please call the Customer Care cCentre to arrange an engineers visit.

The grill pan

This appliance comes with a grill pan, grill pan handle and a trivet. The handle of the grill pan is detachable to allow you to remove it while the pan is in use, this stops it from getting hot.

To attach the handle:

Place the handle over the narrow edge of the grill pan and slide to the centre as shown in the diagrams below:

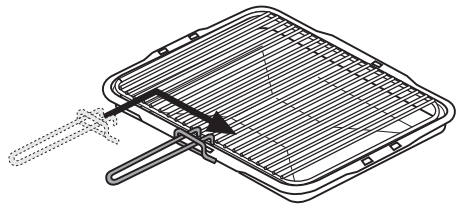
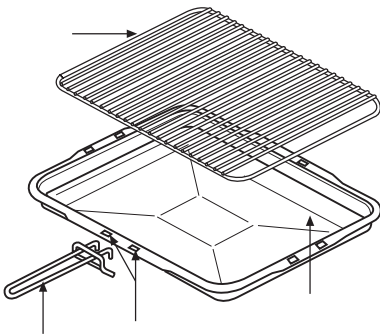

Please note: the grill pan handle is designed for sliding the grill pan into and out of the grill cavity. It is not to be used for lifted the pan.

Aluminium foil:

Never cover the grill pan, or grill trivet with cooking foil, or allow fat to build up in the grill pan as this creates a fire hazard.

This is an approximate guide only, results can be adjusted depending on taste and personal preferences.

Food Type	Trivet Position	Shelf Position	Time Approximate (mins)
Bacon	High	1	8 - 15
Sausages	High	1	12 - 15
Chops ● Lamb ● Pork	High High	2 3	10 - 15 15 - 25
Toast ● 2 rounds ● 4 rounds	High High	1 1	2 - 3 (per side) 2 - 3 (per side)
Bread products ● Buns ● Tea cakes	Low Low	2 2	2 - 3 (per side) 2 - 3 (per side)
Cheese on toast ● 2 rounds ● 4 rounds	High High	1 1	6 - 7 6 - 7
Fish: ● fillets	Low	4	10 - 15
Chicken: ● fillets	Low	depending on size 4 - 5	20 - 30
Beef Steaks: ● rare ● medium ● well done	High High High	1 2 2	7 - 10 10 - 15 15 - 20
Gammon Steaks	High	1	12 - 15

The following appliances have an Electric Grill: **Sterling 1000G & 1100G, Gourmet 1100G**

Getting started

This is a dual grill inside a gas oven compartment, when the electric grill is in use, you cannot use the gas oven.

Before you use the grill, make sure you have placed the grill shelf in the position you need as once the grill is on you may injure yourself if you try and move the shelf.

If you close the grill door, the half grill will work, but not the full grill - this is to stop it becoming too hot inside the grill.

Switching on the grill

- Open the oven door and make sure the shelf is where you would like it to be.
- Do not close the door while the grill is in use.
- Turn the selector control knob anti-clockwise to chose the half grill, or clockwise to use the full grill. Both grill types have heat settings of 1 - 5.
- The fascia cooling fan will come on to keep the control panel and control knobs cool - it will run for some time after the grill has been turned off.
- Select the heat setting you wish to use, 1 (low) - 5 (high) and place the food under the grill.

Important: Do not leave the grill unattended while it is in use.

For best results, pre-heat the grill for about three minutes.

Cooling fan

The grill comes with a cooling fan which is designed to keep the fascia and controls cool while the grill is in use. The fan comes on automatically once the grill is in use and will continue for around 10 minutes after the grill has been switched off.

Thermostat indicator neon

When the grill is selected, the thermostat indicator neon will turn on. If a high grilling temperature is selected, the neon will remain on all the time the grill is in use. When lower temperatures are selected the neon will turn on and off as the thermostat operates to maintain the lower heat.

The grill pan

This appliance comes with a grill pan, grill pan handle and a trivet. The handle of the grill pan is detachable to allow you to remove it while the pan is in use, this stops it from getting hot.

To attach the handle:

Place the handle over the narrow edge of the grill pan and slide to the centre as shown in the diagrams below:

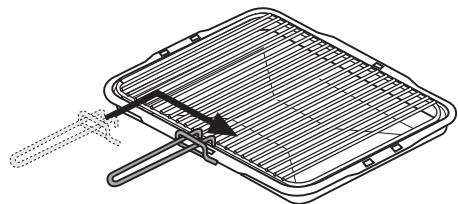
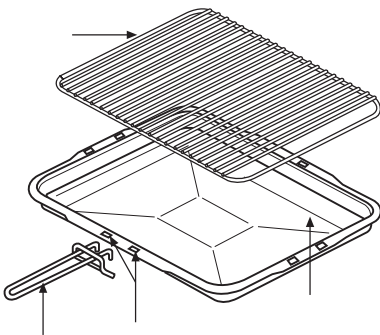

Please note: the grill pan handle is designed for sliding the grill pan into and out of the grill cavity. It is not to be used for lifted the pan.

This is an approximate guide only, results can be adjusted depending on taste, size of portion and personal preferences. All times are based on full heat grilling.

Food Type	Trivet Position	Shelf Position	Time Approximate (mins)
Bacon	high	5	8 - 15
Sausages	low	3	12 - 15
Chops ● Lamb ● Pork	low low	4 3	10 - 15 15 - 25
Toast ● 2 rounds ● 4 rounds	high high	5 5	1 - 2 (per side) 1 - 2 (per side)
Bread products ● Buns ● Tea cakes	low low		1 - 2 (per side) 1 - 2 (per side)
Cheese on toast ● 2 rounds ● 4 rounds	high high	4 4	4 - 5 4 - 5
Fish: ● fillets	low	2	10 - 15
Chicken: ● fillets	low	depending on size 1 - 2	20 - 30
Beef Steaks: ● rare ● medium ● well done	high low low	5 4 4	7 - 10 10 - 15 15 - 20
Gammon Steaks	high	4	12 - 15

Using the Top Oven safely

Warning: Accessible parts may become hot when the oven is in use. Children should be kept away.

- ✓ Always make sure children are supervised if they are near the top oven when it is in use.
- ✓ Always take care when removing food from the top oven as the area around the top oven may be hot.
- ✓ Always use oven gloves when handling any utensils which have been in the top oven as they will be hot.
- ✓ Always use the Minute Minder (if fitted) if you are leaving the top oven unattended, this reduces the risk of food burning.
- ✓ Always make sure that the top oven shelf is resting in the correct position in between two runners. Do not place the top oven shelf on top of the highest runner, this will lead to spillage and injury if the baking tray, or dish falls.
- ✗ Do not place items of the door while it is open.
- ✗ Do not wrap foil around the top oven shelf, or allow it to block the flue.
- ✗ Do not drape tea towels near the top oven while it is on, this will cause a fire hazard.
- ✗ Do not pull heavy items out from the top oven on the shelf, as they may overbalance and fall.

The following appliances have a Top Oven: **Richmond 1000G & 1100G**

Getting started

This is a secondary oven and is ideal for smaller dishes.

The top oven is a conventional oven

Switching on the oven

- Instead of turning the control knob towards the grill setting, turn it towards the oven setting, and select the temperature you require.
- This appliance has an automatic ignition, once the burner flame has established, selected the gas mark you wish to cook with. If the oven fails to light within 15 seconds, turn off the oven and wait for one minute before attempting to reignite.
- Should the oven burner go out while in use, turn the burner off and wait for at least one minute before attempting to reignite.
- As this is a conventional oven, the centre of the cavity will be the temperature you have selected. The top of the cavity will be slightly hotter, and the bottom slightly cooler.
- To switch off the top oven, simply turn the control knob back to the '●' position.
- As with the grill, the cooling fan will come on as soon as the top oven is turned on, and it continues to run for around 10 minutes after use.

Pre-heating

To get the best results from your conventional top oven, we recommend pre-heating for around 5 to 15 minutes before placing your dishes in. This is especially important for items which are chilled, frozen, batter based, yeast based or whisked sponges.

If you are using the main oven at the same time as the top oven, you can reduce the pre-heating time, to take into account heat transfer.

Oven and bake ware

In addition to pre-heating, it is also important that you use good quality cook-ware, poor quality trays and tins can warp in the heat of the oven, producing uneven results. In addition it is important to make sure that any dishes placed in the oven are oven proof and suitable for periods of heating, and are not cracked or damaged as this may lead to shattering.

Times & Temperatures

When cooking chilled or frozen meals, always pre-heat the oven and use the recommended temperatures on the packages.

The timing given on any packaging can be adjusted to suit personal taste - but ensure food is piping hot throughout before eating.

Always follow the manufacturers instructions on the packaging.

Cleaning the top oven



Always allow the oven to cool before cleaning.

Some foods can cause fat to spit, especially if you have open roasted, this leaves the inside of the cavity greasy. It is important to clean the oven cavity as a build up of fat can damage the appliance and may invalidate your guarantee.

Using a trivet while roasting may help to reduce fat splashes.

Chrome plated parts.

Grill shelves & Shelf runners.

- Use a moist soap filled pad, or place in a dishwasher.
- Shelf runners can be removed to enable you to clean them thoroughly. Grasp the runners and slide out of their hanging holes.

Pristine enamel surfaces.

Oven cavity

- The enamel can be cleaned by wiping the surfaces with a clean cloth which has been wrung out in hot, soapy water.
- If larger splashes of fat do not readily disappear, you can use a mild cream cleaner to remove them. More stubborn marks can be removed using a soap filled pad, eg. "Brillo"
- Rinse well.

Do not use:

Caustic cleaners.
Corrosive or abrasive cleaners.
Bleaches.
Coarse wire wool.
Hard implements.

These will damage your appliance.

Using the Main Oven safely

- ✓ Always make sure children are supervised if they are near the oven when it is in use.
- ✓ Always take care when removing food from the oven as the area around the top oven may be hot.
- ✓ Always use oven gloves when handling any utensils which have been in the oven as they will be hot.
- ✓ Always use the Minute Minder (if fitted) if you are leaving the oven unattended, this reduces the risk of food burning.
- ✓ Always make sure that the oven shelves are resting in the correct position in between two runners. Do not place the oven shelves on top of the highest runner, this will lead to spillage and injury if the baking tray, or dish falls.
- ✗ Do not place items of the door while it is open.
- ✗ Do not wrap foil around the oven shelves, or allow it to block the flue.
- ✗ Do not drape tea towels near the oven while it is on, this will cause a fire hazard.
- ✗ Do not pull heavy items, such as turkeys, or large joints of meat, out from the oven on the shelf, as they may overbalance and fall.
- ✗ Do not use this appliance to heat anything other than food items, and do not use it for heating the room.

These ovens are conventional ovens which means that the cavity will be hotter at the top and slightly cooler at the bottom. The temperature at the centre of the oven is the temperature you have selected.

In order to get the best out of your oven, we recommend the following when using it:

Preheating

Always preheat the oven this may take up to 20 minutes, but it will ensure that your oven is at the optimum temperature to begin cooking. If you do not pre-heat the oven you will need to adjust cooking times given in the guides within this book.

Zones of Heat

The gas mark you have selected corresponds with the temperature in the centre of the oven. The temperature towards the top of the oven is higher, and towards the bottom is lower.

Zones of heat within the oven cavity can be used to vary your cooking results depending on personal taste. If you like a darker result, you can place your dishes on a higher shelf, if you prefer paler results, you can use the lower shelf.

Zones of heat can also allow you to cook dishes which require slightly different cooking temperatures at the same time, by placing your shelves higher or lower as required.

The base of the oven can also be used as a cooking position which is equivalent to gas mark 1 - 2 for certain dishes such as milk puddings, warming bread rolls and soups, and baking fruit.

Getting started

The main ovens may be controlled by the programmer, either on its own or with the other oven (see 'The Programmer/Clock' section for details). The programmer must be set to manual before it can be used, or programmed.

Switching on the oven

- Using the main oven control knob, push in and turn to the full on position.
- This appliance has an automatic ignition, once the burner flame has established, selected the gas mark you wish to cook with. If the oven fails to light within 15 seconds, turn off the oven and wait for one minute before attempting to reignite.
- Should the oven burner go out while in use, turn the burner off and wait for at least one minute before attempting to reignite.
- To switch off the main oven, simply turn the control knob back to the '●' position.
- As with the top oven, the cooling fan will come on as soon as the top oven is turn on, and it continues to run for around 10 minutes after use.

Pre-heating

To get the best results from your oven, we recommend pre-heating for around 5 to 15 minutes before placing your dishes in. This is especially important for items which are chilled, frozen, batter based, yeast based or whisked sponges.

Oven and bake ware

In addition to pre-heating, it is also important that you use good quality cook-ware, poor quality trays and tins can warp in the heat of the oven, producing uneven results. In addition it is important to make sure that any dishes placed in the oven are oven proof and suitable for periods of heating, and are not cracked or damaged as this may lead to shattering.

Do not use baking trays or roasting tins which are too large as this will affect your cooking results. We recommend the following sizes:

Baking tray - 350mm x 280mm. This size tray will hold up to 16 small cakes.

Roasting tin - 370mm x 320mm.

Important:

If you find that over a period of time, the oven becomes hotter when used at a particular gas mark, the thermostat may need to be replaced. Please call our Customer Care Centre to arrange an engineers visit.

Food Type	Gas Mark Recommended	Time Approx.	Pre-heat?	Shelf Position
Cakes Small cakes Whisked sponge Swiss roll Victoria sandwich Genoese sponge Madeira Semi rich fruit cake Christmas cake Dundee cake	5 5 6 4 5 3 2 3 3	15 - 25 15 - 20 10 - 12 20 - 30 20 - 25 1 - 11/4hrs 2 1/2 - 3hrs 2 1/2 - 3hrs 2 1/2 - 3hrs	yes yes yes yes yes yes yes yes yes	top - middle middle middle top - middle middle middle - top middle - top middle - top middle - top
Pastry Flaky/Puff Shortcrust Choux Plate tarts	7 6 7 6	timing depends on recipe type & filling	yes yes yes yes	top - middle top - middle top - middle top - middle
Biscuits Shortbread rounds Nut brownies Brandy snaps Flapjacks Ginger nuts	3 3 3 4 5	20 - 25 20 - 25 10 - 12 20 - 25 10 - 20	yes yes yes yes yes	middle - top middle - bottom top - middle middle top - middle
Puddings Rice pudding Baked custard Bread & butter pudding Fruit crumble	2 2/3 3 5	1 3/4 - 2hrs 50 - 60 45 - 1hr 40 - 1hr	yes yes yes yes	middle middle - bottom middle middle
Miscellaneous Yorkshire pudding: large small Toad in the hole Bread: 2 x 1lb loaves Bread rolls	7 7 7 7 7	40 - 45 15 - 20 40 - 45 20 - 30 10 - 15	yes yes yes yes yes	top - middle top - middle middle top - middle middle - top

Roasting guide

- Roasting times depend on the weight, shape and texture of the meat, and of course, personal preference. In order to calculate the roasting time, weigh the meat or poultry, **including the stuffing**, and follow the times given in the roasting guide.
- Frozen meat must be **thoroughly** thawed before cooking. For large joints, it is advisable to thaw overnight.
- Frozen poultry must be **thoroughly** thawed before cooking. The time required depends on the size of the bird - eg: a large turkey may take up to 48 hours to thaw.

The times given in the roasting guide are only **approximate** because the size and age of the bird will influence cooking times, as will the shape of the joint and the proportion of bone.

Helpful hints for roasting

- When cooking stuffed meat or poultry, calculate the cooking time from the **total** weight of the meat **plus** the stuffing.
- Cooking joints in foil, covered roasters, lidded casseroles, or roasting bags will help to reduce meat shrinkage, give a more moist result and may reduce fat splashing. However, a slightly longer cooking times will be required, **add 5 - 10** minutes per 450g (1lb) to the calculated cooking time. When using roasting bags do not exceed the temperatures recommended by the manufacturer, and do not allow the roasting bag to touch the sides or top of the oven.
- Smaller joints weighing less than 1.25kg (2½lb) may require 5 minutes per 450g (1lb) extra cooking time.
- Use of a trivet with the roasting tin will reduce fat splashing during open roasting, and will help to keep the oven interior clean. To further reduce any fat splashing, potatoes or other vegetables can be roasted around the joint.
- The use of a roasting tin larger than that supplied or recommended is not advised, as this may impair performance and lead to extended cooking times.

This is an approximate guide only, results can be adjusted depending on taste and personal preferences. Shelf positions are given from bottom to top.

Type of meat	Gas Mark	Time Approx.	Shelf number	Pre-heat?
Beef	5	20 - 30 minutes per 450g (1lb) + 20 minutes Depending on taste	2	Yes
Lamb	5	25 - 30 minutes per 450g (1lb) + 20 minutes Depending on taste	2	Yes
Pork	5	35 minutes per 450g (1lb) + 35 minutes	2	Yes
Chicken	5	25 - 30 minutes per 450g (1lb) + 20 minutes	2	Yes
Turkey up to 5.5kg/12lb	4	20 minutes per 450g (1lb) + 20 mins	2	Yes
over 5.5kg/12lb	4	20 minutes per 450g (1lb) + 20 mins		

Roasting Turkeys

The maximum size Turkey for this appliance is: 20lbs / 10kgs.

Please do not attempt to roast a Turkey larger than this, as the results cannot

Roast turkey

Roasting turkey perfectly involves cooking two different types of meat - the delicate light breast meat, which must not be allowed to dry out, and the darker leg meat, which takes longer to cook.

The turkey must be roasted long enough for the legs to cook, so frequent basting is necessary. The breast meat can be covered once browned.

- Turkey should be roasted at Gas Mark 4 for 20 mins per 1lb, plus 20 minutes.
- The turkey can be open roasted, breast side down, for half of the cook time, and then turned over for the remainder of the cooking time.
- If the turkey is stuffed, **add** 5 minutes per 1lb to the cooking time.
- If roasting turkey covered with foil, **add** 5 minutes per 1lb to the cooking time.

To test if the turkey is cooked, push a fine skewer into the thickest part of the thigh. If the juices run clear, the turkey is cooked. If the juices are still pink, the turkey will need longer cooking.

Introduction

One of your oven compartments is an electric oven which provides a gentle heat suitable for slow cooking or keeping food warm. The oven is operated by a button at the right hand of the fascia, and a red neon will illuminate to show that the oven is switched on. Please check which side the slow cook oven is on, by looking at the specification at the front of this handbook.

The slow cook element is positioned in the base of the lower compartment - always make sure that the prepared cooking pot is placed centrally on the base of this compartment.

Do not use either compartment to store food or canned items.

Do not use the upper compartment for slow cooking, or food warming.

Cooking times

The cooking time varies according to the type of food being cooked, and experience will show how long foods should be cooked for, according to personal taste and preference.

In general foods should be cooked for at least 5 hours, and may be left up to 8 - 10 hours without spoiling if covered. As a guide, foods cooked using the slow cook oven will take about three times longer than they would in a conventional oven.

Utensils

Any oven proof utensils may be used for slow cooking, provided they have a close fitted lid.

To rectify a badly fitting lid a piece of cooking foil may be placed over the dish, under the lid.

For convenience and to save washing up, the most useful utensils for slow cooking are the flame proof type which can be used over direct heat and for oven cooking, and are sufficiently attractive to use as serving dishes.

Keeping food warm

Turn the oven on, and allow to preheat for 20 minutes before placing the food in the oven. If food is to be kept moist then it is important to cover the dish or plate to prevent food from drying out. This can be done using aluminium foil if the dish does not have a lid.

Do not use cling film to cover food as it cannot withstand the heat produced in the oven.

Some foods are best left uncovered if you wish to keep the food dry and crisp.

Do not add gravy to plated meals until serving.

Carved meat should be placed on one plate and covered, adding just one table-spoon of gravy to keep it moist.

When keeping plated meals warm it is recommended that the food is placed on hot rather than cold plates.

Slow Cooking

Slow cooking has always been the best way to prepare a nutritious hot meal with the minimum of preparation and maximum time away from the kitchen. The benefits of slow cooking have been recognised by cooks for centuries, and are still appreciated by cooks today. The advantages of slow cooking are as follows:

- Food can be left to cook unattended for several hours and will keep hot for several hours if left covered, without spoiling for a further 2 - 3 hours, so foods can be left to cook while you are out for the day, or over night.
- Inexpensive cuts of meat become deliciously tender when slow cooked.
- Slow cooking will also produce moist, tender "roasts" with minimal meat shrinkage and reduced oven soiling.
- Dishes such as soups, vegetables, puddings savoury dishes and preserves are also suitable for slow cooking.
- There is no topping up of steamers, steam filled kitchens or constant checking to do.

Using the slow cook oven

Turn the oven on and preheat for 20 minutes. Always place the prepared cooking pot centrally on the base of the oven. Follow the guide lines for the best results.

- The maximum capacity of ovenproof dishes should be no more than 2.5 litres (4.5 pints). Please note: The more you fill the dish/pot the longer it will take to cook.
- Cooking times will vary depending on the size and shape of the meat, or poultry.
- **Always** bring soups, casseroles and liquids before placing in a preheated oven. To give more colour to meat or poultry, fry the meat to brown and add to stock which is hot.
- All meat and poultry recipes need a minimum of 5 hours to cook.
- Make sure all frozen ingredients are well thawed out.
- **Always** ensure that frozen poultry has thoroughly **defrosted** in a refrigerator and all ice crystals have melted.
- Cut root vegetables into smaller pieces as they take longer than meat to cook. If possible they should be sauteed for 2 - 3 minutes before slow cooking.
- Ensure that root vegetables are always at the bottom of the pan immersed in the cooking liquid.
- A meat thermometer should be used when cooking pork joints and poultry. The internal temperature of the food should reach 88°C,
- Stuffed meat or stuffed poultry should not be slow cooked. Cook any stuffing separately.
- Cover casseroles with a lid, or foil to prevent loss of moisture.
- Adjust seasonings and thickenings at the end of cooking time.
- Dried red kidney beans must be boiled for a minimum of 10 minutes following soaking before inclusion in any dish.
- Opening the door during cooking, leads to heat loss, and will lead to increased cooking times.

Trouble-shooting - Fruit Cakes

PROBLEM	POSSIBLE CAUSE
Fruit sinking to the bottom	Low oven temperature which may cause the cake to take longer to set, allowing the fruit to sink. Or, too much liquid, or raising agent. The fruit may not have been properly washed and dried.
Cake sinking / dipping in the centre	Too much raising agent in the mixture. Too hot, or too cool an oven. Or, not enough liquid or insufficient creaming.
Surface cracks	Too small a tin, or too much mixture in the tin. Too much raising agent in the mix, plus not enough liquid or insufficient creaming. The oven may be too hot.
Hard outer crust with a damp patch inside	Oven too hot, therefore the cake baked too quickly. Too much sugar, or insufficient liquid.
Burnt outside	Oven temperature too high. Oven too small for the size of cake. Insufficient protection around the tin. Cake baked on too high a shelf.
Texture with pronounced holes.	Too much raising agent. Flour unevenly mixed.
Texture too close and cake insufficiently risen.	Not enough raising agent. Not enough liquid. Too cool an oven. Insufficient creaming.
Cake crumbles when cut	Not enough liquid. Baked for too long. Not enough sugar. Too much baking agent.
Too dry	Over baking. Insufficient egg or liquid. Too much raising agent.

Trouble-shooting - Biscuits & Batters

PROBLEM	POSSIBLE CAUSE
Hard and brittle biscuits	Over baking or insufficient liquid
Biscuits spreading during baking	Oven too cool. Baking tray over greased. Too much sugar
Soggy, heavy and tough batter	Batter too thick. Tin too small. Oven too cool or fat insufficiently heated.
Poor rising	Batter too thin. Oven too cool or fat insufficiently heated.

Trouble-shooting Sandwich cakes & Sponges

PROBLEM	POSSIBLE CAUSE
Domed top	Insufficient creaming of mixture. Cake baked on too high a shelf position, or at too high a temperature. Paper liners can cause the outer edge not to rise and the centre to peak.
Hollowed / sunken top	Too much raising agent. Oven temperature too low, or incorrect shelf position. Cake removed from oven before it's cooked. Use of soft tub margarine.
Very pale, but cooked	Oven temperature too low. Baked too low in the oven
Overflowing tin	Tin too small for the amount of mixture

Trouble-shooting Sandwich cakes & Sponges cont'd

PROBLEM	POSSIBLE CAUSE
Close / doughy texture	Too much liquid. Too little flour. Too much sugar. Insufficiently creamed. Not enough raising agent. Ingredients too warm. Insufficient air incorporated during mixing.
Over baked outside, undercooked centre	Oven temperature too high. baked on too high a shelf position.
White sugar spots on the top when baked.	Mixture not sufficiently creamed. Granulated sugar used instead of caster sugar. Insufficient liquid. Cake baked too slowly.
Shrinkage	Insufficient baking powder or sugar. Over mixing.
Ring around the outer edge of the cake	Over-greasing of the baking tin.

Trouble-shooting - Scones & Teabreads

PROBLEM	POSSIBLE CAUSE
Heavy and badly risen	Insufficient raising agent. Heavy handling during kneading. Not enough liquid. Oven too cool, or scones baked on too low a shelf position.
Scones spread out and lost their shape.	Too much liquid. Over-greased tin. Incorrect kneading. Twisting the cutter while stamped out the shapes.
Very rough surface	Insufficient kneading
Pale and doughy	Insufficient baking. Oven temperature set too low or baked on too low a shelf position.

Trouble-shooting - Bread

PROBLEM	POSSIBLE CAUSE
Dough collapses when placed in oven	Over proving
Heavy / Close texture	Insufficient yeasts. Too much salt. Too little water. Insufficient kneading or proving. Oven too cool. Dough proved in too warm an environment.
Uneven texture / holey texture	Insufficient kneading. Too much liquid or salt. Oven too cool.
Top crust breaks away	Under proving. Oven too hot.
Cracked crust	Tin too small for amount of dough. Second proving too short
Crust cracks after removal	Cooling in a draught. Over proving. Oven too hot

Trouble-shooting - Pastry

PROBLEM	POSSIBLE CAUSE
Hard and tough	Insufficient fat. Too much liquid. Over baking. Oven too cool.
Soggy	Too much liquid. Oven too cool. Insufficient baking. Lack of a steam vent. Filling too hot when covered by pastry.
Shrinking	Over-stretched during rolling or shaping. Insufficient resting time.
Blistered crust	Rubbing in process incorrect. Water insufficiently mixed in.

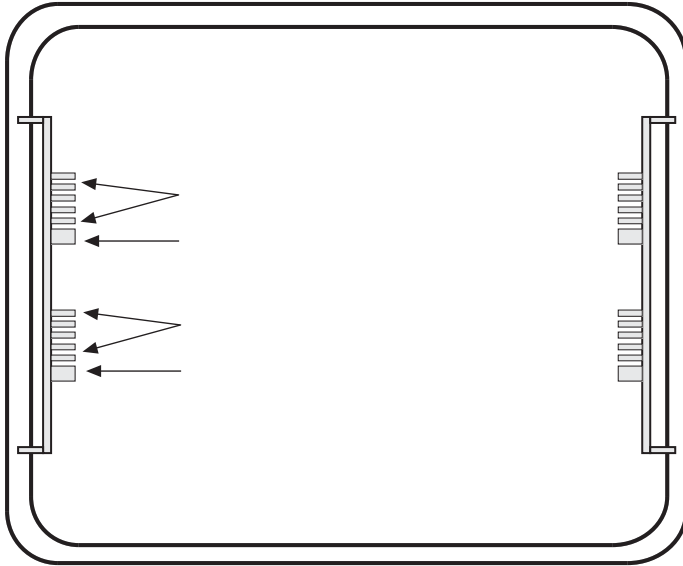

The telescopic shelving system is a new method of supporting the shelves in your oven and grill.

In addition to the traditional shelving fitted into your appliance, the telescopic shelving system is fitted in the most commonly used location in your cavity.

The shelves with the telescopic system are easier to pull out than traditional shelving, which means the oven door stays open for a shorter period of time. The smooth action also reduces the likelihood of fat, or food, spillage, and gives you extra security.

The telescopic shelving position also provides extra support, which is ideal when cooking a casserole in a heavy dish, or a particularly large roast.

You do not have to use the telescopic shelves all the time, you can place the shelves in the traditional positions if you would like more choice.

The telescopic shelves remove easily from the runner for repositioning or cleaning, but we recommend that you reposition your shelving before cooking, and remove the shelving for cleaning only when the shelves are cold to prevent burning yourself.

To remove the telescopic shelves:

Make sure the shelf is cool enough to touch, or use oven gloves.

Push the oven shelf back into the cavity, until it hits the stop position.

Grasp the shelf bars in the centre, and lift the back of the shelf clear of the stop position.

You can then lift the front of the shelf clear of the retaining tabs.

To replace the telescopic shelves:

Make sure the oven runners are pushed all the way back into the cavity.

Tilt the shelf and make sure the front of the shelf is against the stop position.

Carefully place the shelf back onto the runner and snap in place firmly.

Make sure the back of the self is inside the retaining tabs and slide it in and out of the oven to make sure it works correctly.

Standard shelves:

Standard shelves are removed by pulling them straight out towards you and are replaced by sliding them straight into the oven to the back of the cavity.

These shelves can be cleaned in the dishwasher.

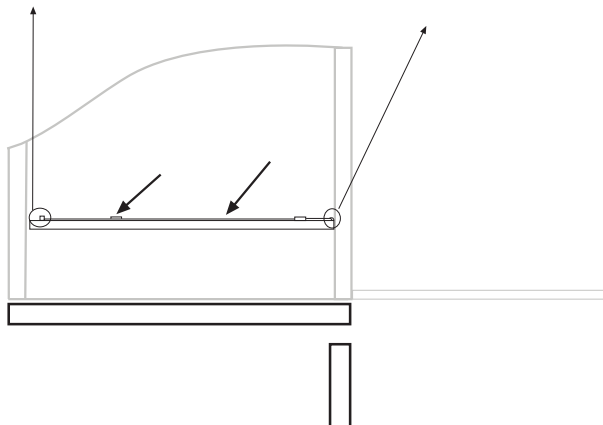

Cleaning the main oven



Always allow the oven to cool before cleaning.

Some foods can cause fat to spit, especially if you have open roasted, this leaves the inside of the cavity greasy. It is important to clean the oven cavity as a build up of fat can damage the appliance and may invalidate your guarantee.

Using a trivet while roasting may help to reduce fat splashes.

Chrome plated parts.

Grill shelves & Shelf runners.

- Use a moist soap filled pad, or place in a dishwasher.
- Shelf runners can be removed to enable you to clean them thoroughly. Grasp the runners and slide out of their hanging holes.

Pristine enamel surfaces.

Oven cavity

- The enamel can be cleaned by wiping the surfaces with a clean cloth which has been wrung out in hot, soapy water.
- If larger splashes of fat do not readily disappear, you can use a mild cream cleaner to remove them. More stubborn marks can be removed using a soap filled pad.
- Rinse well, and turn on the oven to speed up drying if required.

Do not use:

Caustic cleaners.
Corrosive or abrasive cleaners.
Bleaches.
Coarse wire wool.
Hard implements.

These will damage your appliance.



Always allow your appliance to cool down before cleaning any part of it.

Painted, plastic, metal finish & gold coloured parts (where fitted)

control knobs & programmer buttons, painted metal door & fascia panels, side panels, handles, grill pan handle

- Only use a clean cloth wrung out in hot soapy water.

Do not use abrasive cleaners, wire or nylon cleaning pads on these parts.

Take extra care when cleaning over symbols on fascia panels, excessive cleaning can lead to the symbols fading.

Glass parts

glass door panels, glass lid (if fitted)

- Only use a clean cloth wrung out in hot soapy water, or a specialist glass cleaner.
- Rinse away any excess cleaner and dry with a soft cloth.
- Do not use abrasives or polishes as they will scratch and damage the glass.

Warning: Do not operate the appliance without the glass panel correctly fitted.

Important: the inner door glass panel can be removed for cleaning but it must be replaced the right way up (so the reflective side - if fitted - faces inward), and pushed fully in to the **stop** position. To remove the glass panel, open the door wide, hold the top and bottom edges and slide out.

Glass door panels

To meet the relevant Standards of Domestic cooking appliances, all the glass panels on this appliance are toughened to meet the fragmentation requirements of BS 3193. This ensures that, in the unlikely event that a panel breaks, it does so into small fragments to minimise the risk of injury.

Please take care when handling, using or cleaning all glass panels, as any damage to the surfaces or edges may result in the glass breaking without warning or apparent cause at a later date.

Should any glass panel be damaged, we strongly recommend that it is replaced

Aluminium surfaces (Aluminium finish models only)

fascia panel, door handles, doors

- Use a clean cloth wrung out in hot soapy water, and dry with a soft cloth.
- More stubborn marks can be removed using **diluted** liquid cleaner in the correct concentration (according to manufacturers instructions. We recommend that you clean the whole of the aluminium area to maintain a uniform finish.
- Do not use cream cleaners, as they will mark the surface.
- Do not use undiluted bleach or any products containing chlorides as they can permanently damage the aluminium.

Wipe any spillage immediately, taking care to avoid burning your hands.

Stainless steel surfaces (Stainless steel finish models only)

fascia panel, door handles, doors

- Only use a clean cloth wrung out in hot soapy water, and dry with a soft cloth.
- Stubborn marks can be removed using a stainless steel cleaner. We recommend that you clean the whole of the stainless steel area to maintain a uniform finish. Supplies can be purchased from the Customer Care Centre.
- Do not use undiluted bleach or any products containing chlorides as they can permanently damage the steel.

Sharp objects can mark the surface of stainless steel, but will become less noticeable with time.

To maintain the finish of the stainless steel, or to remove any greasy marks, rub the stainless steel surface sparingly with a minimum amount of Baby Oil.

Do not use cooking oils, as these may contain salt which can damage the stainless steel surface.

Some foods are corrosive eg; vinegar, fruit juices and especially **salt** - they can mark or damage aluminium if they are left on the surface.

Always make sure that your appliance is fitted correctly, by a competent installer. Failure to do this will invalidate any warranty, or guarantees and will lead to you being charged for labour and parts.

This is a Class 1 appliance regarding installation requirements.

Before you start

Always make sure that you have carefully read through the installation pages of this book - careful planning at the beginning will ensure a quick and easy installation.

- Take care when moving this appliance, it may be heavier than it looks! If you need to lift the appliance, make sure you use an appropriate lifting method.
- Soft, or uneven flooring may be damaged unless the appliance is moved with care.
- Do not attempt to move the cooker by pulling on the handles or doors, we recommend that you open the door and grasp the frame of the cooker. Please wear protective gloves for this, and make sure the door cannot trap your fingers.

The full dimensions of your appliance are shown in the introduction section of this book - please make sure that you have enough space for your appliance. Clearances and more installation details are given on the following page.

Clearances - Waist Level

This cooker may be fitted flush to the base units of your kitchen.

- No shelf, overhang, cupboard, or cooker hood should be less than 650mm above the hob top, but please check this with the hood manufacturers instructions.
- If your appliance has a side opening door, we recommend a side clearance of 60mm to allow the oven door to fully open.
- The cooker must have a side clearance above hob level of 90mm up to a height of 400mm.
- The important dimensions are the ones around the appliance

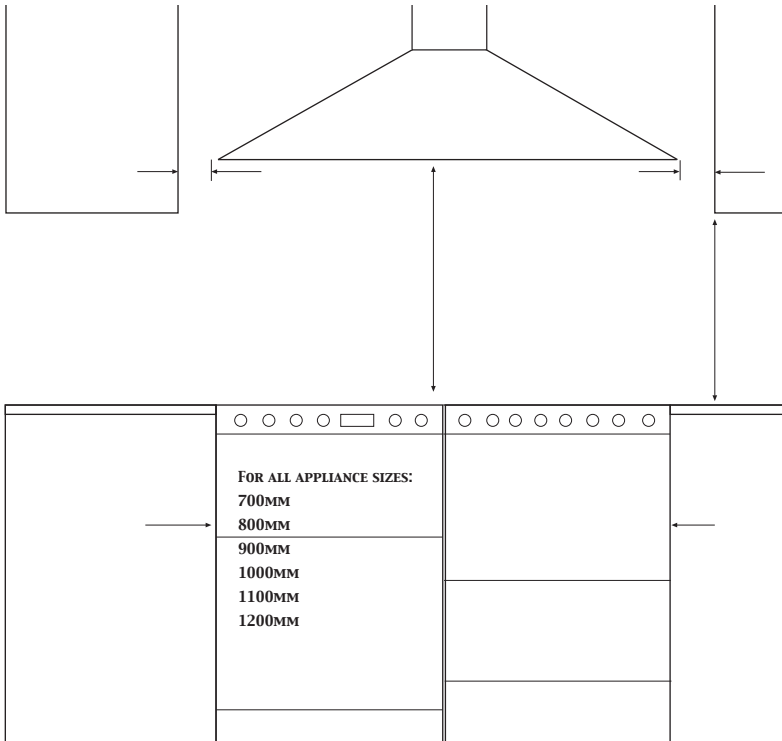

The information below is crucial to installing this appliance correctly and safely.

Ventilation Requirements

The room containing the appliance should have an air supply in accordance with BS 5440:Part 2.

- All rooms require an openable window, or equivalent, and some will require additional venting also.
- For room volumes up to 5m^3 an air vent of 100cm^3 is required.
- If the room has a door which opens directly to the outside, or exceeds 10m^3 - no air vent is required.
- If there are other fuel burning appliances in the same room, BS 5440:Part 2 should be consulted to determine the air vent requirements.
- This appliance must not be fitted into a bed sitting room of less than 20m^3 or into a bath or shower room.

The use of a gas cooking appliance results in the production of heat and moisture in the room in which it is installed. Ensure that the kitchen is well ventilated: keep natural ventilation holes open or install a mechanical ventilation device (mechanical extractor hood). Prolonged intensive use of the appliance may call for additional ventilation, for example opening of a window, or more effective ventilation, for example increasing the level of mechanical ventilation where present.

Windows and vents should not be blocked or removed without first consulting a competent engineer.

LPG only - do not install this appliance below ground level. This does not preclude installation into rooms which are basements with respect to one side of the building, but open to ground level on the opposite side.

Failure to install appliances correctly is dangerous and could lead to prosecution.

The information below is crucial to installing this appliance correctly and safely.

UK Regulations & Standards

always refer to the most recent issue of the standards

- Gas Safety Regulations.
- Building Regulations - issued by the Department of the Environment.
- Building Standards (Scotland) (Consolidated) - issued by the Scottish Development Department.
- I.E.E. Wiring Regulations.
- Electricity at Work Regulations.
- BS 6172 Installation of Domestic Gas Cooking. For LP Gas, refer to BS 5482 Part 1, Part 2 or Part 3 as relevant.
- Installation and Servicing Instructions for this appliance.

For installation in countries other than the UK, the appliance must be connected in accordance with all local gas and electrical regulations.

Failure to install appliances correctly is dangerous and could lead to prosecution.

Connecting to the gas supply

An Rp $\frac{1}{2}$ is fitted to the cooker.

Fit the bayonet connection. This should be located so as to ensure that the flexible hose does not kink.

Use a 900mm - 1125mm length of flexible hose.

Ensure that all pipe work is of the correct rating.

Natural Gas - Flexible connections should comply with BS 669. Parts of the appliance likely to come into contact with a flexible connector have a temperature of less than 70 °C.

The appliance is designed not to project in front of standard 600mm work tops - including handles. To achieve best fit the cooker must be pushed against the wall. If the wall mounted adaptor backplate (fig 1) is to be fitted behind the appliance then the suitable area for this fitting is shown as the area on fig 2.

Fig 1

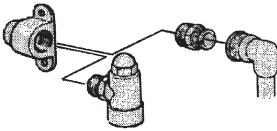

Fig 2

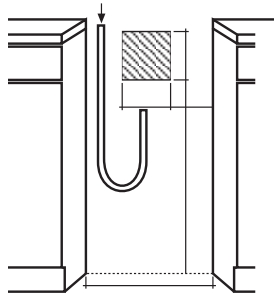
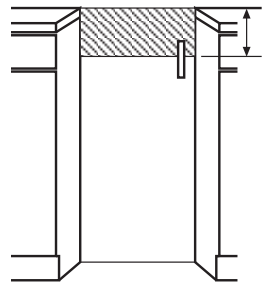

Fig 3



The temperature rise of areas at the rear of the cooker, that are likely to come into contact with the flexible hose do not exceed 70 °C. However, do not allow contact of the hose in the top 150mm (the shaded area in fig 3).

After installation make sure all connections are gas sound.

Connecting to the gas supply

The inlet to the cooker is $\frac{1}{2}$ " BSP internal situated at the rear right corner. Fit the bayonet connection. This should be located so as to ensure that the flexible hose does not kink.

Use a 900mm - 1125mm length of flexible hose.

Ensure that all pipe work is of the correct rating.

LP Gas - For flexible connections use a bayonet type hose, suitable for use on LP gas up to 50mbar pressure rise and 70 °C temperature rise. The flexible hose should be coloured black with a red stripe, band or label. If in doubt, contact your supplier.

After installation make sure all connections are gas sound.

Commissioning - all appliances

Pressure settings:

G20 Natural Gas @ 20mbar

G30 Butane @ 28-30mbar

G31 Propane @ 37mbar

Hob

Turn on gas supply and check for soundness at the hotplate injector. Light two burners and check that the pressure is correct.

Grill

Turn the control knob to the full on position and ignite, allow the grill to operate for a few minutes.

Oven

Turn the control knob to the full on position and ignite, allow the oven to operate for a few minutes.

Connecting to the electricity supply

Mains ignition models only.

Warning - this appliance must be earthed.

The flexible mains lead is supplied connected to a BS 1363 fused plug.

If this plug does not fit in the socket in your home, it should be replaced by a suitable plug as outlined below.

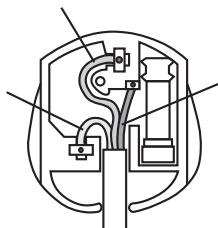

The wires in the mains lead are coloured in accordance with the following code:

Green and Yellow = Earth

Blue = Neutral

Brown = Live

As the colours of the wires in the mains lead of the appliance may not correspond with the coloured markings identifying the terminals in your plug, proceed as follows:

The wire which is green and yellow must be connected to the terminal marked **E** (Earth) or coloured green.

 The wire which is coloured blue must be connected to the terminal marked **N** (Neutral) or coloured black.

The wire which is coloured brown must be connected to the terminal marked **L** (Live) or coloured red.

The plug and socket must be accessible after installation.

Should the mains lead ever require replacing, we recommend that this is carried out by a qualified electrician who will replace it with a lead of the same size and temperature rating.

Important: ensure that you route all mains, electrical cables and flexible tubing well clear of any adjacent heat source.

Stabilising and Securing

Your cooker may come with a stability chain, if it does not we recommend that you buy a stability bracket from your local supplier, this will keep the cooker from moving and will prevent damage to the flexible hosing at the back of the cooker.

Your stability chain

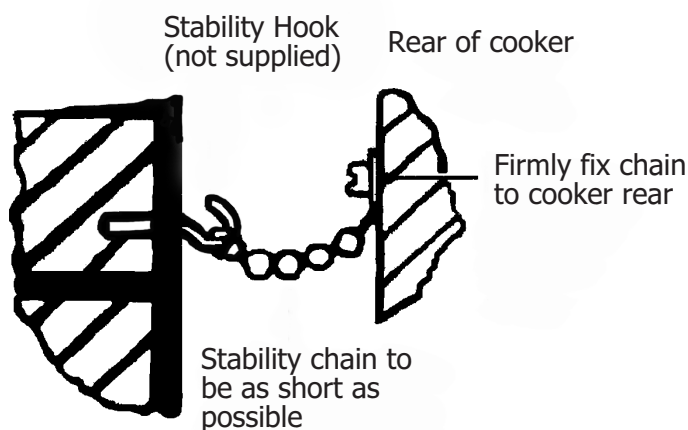

Cooker stability chain not designed with bracket engagement slot

Your cooker must be secured to a wall or a solid partition behind the cooker.

Levelling

Once your cooker is secure, ensure that it is level:

Place a spirit level onto a baking tray, on an oven shelf.

These cookers are fitted with adjustable feet which will allow you to adjust the height of the appliance until it is level. The adjustable feet are at the rear of the cooker.

Richmond Traditional ranges also come with kits for the following accessories: **Plinth cover, Glass splash back & Towel rail**. The instructions for fitting these parts are with the kits on a separate instruction leaflet.

Stabilising and Securing

Your cooker may come with a stability chain, if it does not we recommend that you buy a stability bracket from your local supplier, this will keep the cooker from moving and will prevent damage to the flexible hosing at the back of the cooker.

Your stability bracket

- You can buy a stability bracket from your supplier and it can fitted as follows:
- Place the cooker in position and draw a pencil line level with the front edge.
- Mark the centre of the cooker to give the centre line for the bracket.
- Remove the cooker and mark off 450mm from the pencil line to locate the front edge of the lower bracket.
- Fix the bracket to the floor. Measure from floor level to engagement edge in the back of the cooker and add 3mm.
- Assemble the underside of the top part of the bracket to this height.

Once the cooker is stable, ensure it is level - see the previous page.

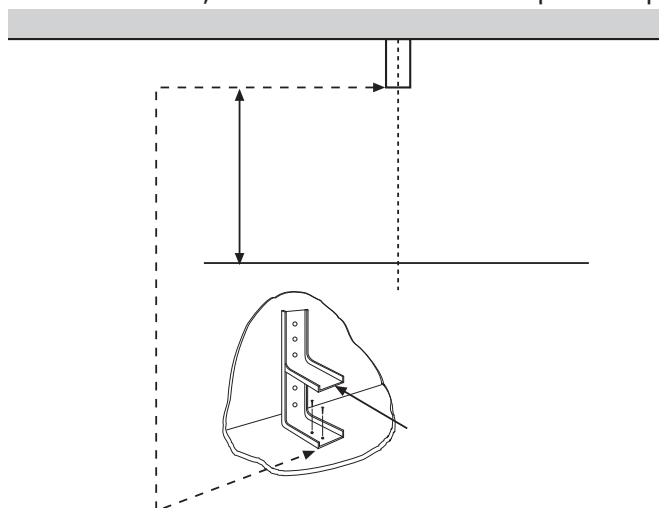

General Data									
Appliance	Gas Category	Gas Type & Pressure setting	Factory Set Gas Type	Oven Lights	Electrical Supply	Countries of Destination	Grill Aeration Sleeve	Gas Total Heat Input Σ Qn. kW	Slow cook oven
Sterling 1000G	I _{2H}	G20 @ 20mbar	G20 @ 20mbar	25W (each)	220-240V ~ 50Hz	GB	Fixed aeration.	19.50	160W electric @230V
Sterling 1100G	I _{2H}	G20 @ 20mbar	G20 @ 20mbar	25W (each)	220-240V ~ 50Hz	GB		19.50	160W electric @230V
Richmond 1000G	I _{2H}	G20 @ 20mbar	G20 @ 20mbar	25W (each)	220-240V ~ 50Hz	GB		21.90	160W electric @230V
Richmond 1100G	I _{2H}	G20 @ 20mbar	G20 @ 20mbar	25W (each)	220-240V ~ 50Hz	GB		21.90	160W electric @230V
Gourmet 1100G	I _{2H}	G20 @ 20mbar	G20 @ 20mbar	25W (each)	220-240V ~ 50Hz	GB		19.50	N/A

	Main Oven 1 (LHS)					Main Oven 2 (RHS)								
Appliance	Burner Type	Nominal Heat	Injector	Bypass Screw	Spark Gap	Burner Type	Nominal Heat	Injector	Bypass Screw	Spark Gap				
Sterling 1000G	Low profile stainless steel burner					3-4 mm	2.5 kW	115	50	3-4 mm				
Sterling 1100G						3-4 mm	2.5 kW	115	50	3-4 mm	2.5 kW	115	50	3-4 mm
Richmond 1000G						3-4 mm	2.5 kW	115	50	3-4 mm	2.5 kW	115	50	3-4 mm
Richmond 1100G						3-4 mm	2.5 kW	115	50	3-4 mm	2.5 kW	115	50	3-4 mm
Gourmet 1100G						3-4 mm	2.5 kW	115	50	3-4 mm	2.5 kW	115	50	3-4 mm

	Semi Rapid									
	Nominal Heat	Injector	Bypass Screw	Spark Gap						
Appliance	Defendi Series 3									
						Sterling 1000G	3 x 2kW	104	46	3-4 mm
						Sterling 1100G	3 x 2kW	104	46	3-4 mm
						Richmond 1000G	3 x 2kW	104	46	3-4 mm
						Richmond 1100G	3 x 2kW	104	46	3-4 mm
						Gourmet 1100G	3 x 2kW	104	46	3-4 mm
	Auxiliary									
	Nominal Heat	Injector	Bypass Screw	Spark Gap						
Appliance	Defendi Series 3									
						Sterling 1000G	2 x 1kW	77	46	3-4 mm
						Sterling 1100G	2 x 1kW	77	46	3-4 mm
						Richmond 1000G	2 x 1kW	77	46	3-4 mm
						Richmond 1100G	2 x 1kW	77	46	3-4 mm
						Gourmet 1100G	2 x 1kW	77	46	3-4 mm

		Wok							
Appliance	Rapid					Spark Gap			
	Burner Type	Nominal Heat	Injector	Bypass Screw	Spark Gap				
Sterling 1000G	Defendi Series 3					3-4 mm			
Sterling 1100G						1 x 3kW	129	60	3-4 mm
Richmond 1000G						1 x 3kW	129	60	3-4 mm
Richmond 1100G						1 x 3kW	129	60	3-4 mm
Gourmet 1100G						1 x 3kW	129	60	3-4 mm
	Defendi Series 3								
	1 x 3.5kW	121 & 63	07		3-4 mm				
	1 x 3.5kW	121 & 63	07		3-4 mm				
	1 x 3.5kW	121 & 63	07		3-4 mm				
	1 x 3.5kW	121 & 63	07		3-4 mm				
	1 x 3.5kW	121 & 63	07		3-4 mm				

Not all appliances have the same number and type of bulbs. Before replacing your bulb, open the top/main oven door and see which type you have. Then use the table below to help you change your bulb correctly.

Please remember that bulbs are not covered by your warranty.

Warning: There is a risk of electric shock, so always make sure your appliance is switched off and unplugged.

Bulbs can be purchased from hardware stores (always take the old bulb with you), or you can call the Spares Sales team on 0870 458 9961.

Number of bulbs	Position & details	Changing instruction
2	Sides Top Oven 25W bulb	<ul style="list-style-type: none">● Switch off the electricity supply, and make sure the oven cavity is cool and remove the shelves.● Grasp the lens cover and pull away from the side of the oven. Unscrew the bulb and replace.
2	Sides Main Oven 25W bulb	<ul style="list-style-type: none">● Switch off the electricity supply and wait until the oven is cool, then remove the oven shelves.● Unscrew the lens, taking care to avoid touching the lamp itself, as this may cause damage.● Pull out the bulb and replace with a new halogen bulb.● Do not touch the new halogen bulb with your bare hands as this will affect the life of the new bulb.

Product description	Product code	Quantity	Where used
Rectangular carbon filters	082612620	2	Hoods
Round carbon filters	082611571	1	Hoods
Ceramic hob scraper kit	082606781	1	All ceramic glass hobs/hob tops including induction.
Ceramic hob cleaner and conditioner	082606780	1	All ceramic glass hobs/hob tops including induction
Sealed hotplate conditioner	082606783	1	All sealed/solid plate hobs/hobtops.
Stainless steel cleaner	082606764	1	All stainless steel parts
Oven cleaner spray	082606786	1	All cookers, inside cavities and on glass.
Multi-purpose kitchen cleaner	082606782	1	General kitchen cleaner.
E-cloth	082813300	1	All cookers, for cleaning glass and stainless steel

To order or enquire about any of these products, please call the Spares Sales team on **0870 458 9961**.

Customer Care Information

Should you need it



Inside the paperwork which has come with this appliance, there is a leaflet and card explaining the terms of our extended warranty and guarantee.

In order to apply for our five year guarantee, simply fill in the details on the card and post it off, this will register your appliance.

Should you wish to take out extended warranty, please fill in the details on the leaflet and post this off.

Alternatively, you can register, and apply for extended warranty on line at:
www.stoves.co.uk/contact/warranty.

If your appliance is covered by the warranty and guarantee, you will not be billed for work undertaken should your appliance be faulty, terms and conditions do apply, so please read through the literature carefully.

Our Customer Care Centre can be called on:

0871 22 22 502

We aim to answer calls as quickly as possible, and in strict rotation as soon as one of our Customer Care team become free.

Please ensure that you have available your appliances model number and serial number, there is a space at the back of this book for recording that information.

Alternatively visit the web site as detailed on the front cover of the handbook.

Outside the UK and Northern Ireland, please contact your local supplier.

Contact Us

In case of difficulty within the UK and Northern Ireland, please call
Stoves Customer Care Centre Helpline on

0871 22 22 502

Please have to hand your appliances Model Number and Serial Number, which can be found on the databadge inside you cooker and recorded here for future reference.

Model Number									
Serial Number									



GLEN DIMPLEX
HOME APPLIANCES

Glen Dimplex Home Appliances Limited is the owner of the Stoves brand and is part of the Glen Dimplex group of companies.

08 27184 03 © 03.2008

Gas Range Cooker

All Sterling, Gourmet & Richmond models