

1100mm

Dual Fuel Range Cookers

with Gas Hotplate, Electric Grill & 2 Electric Ovens
For Natural Gas models & LP Gas models

User & Installation Instructions

STOVES™

Stoney Lane, Prescott, Merseyside, L35 2XW

STOVES™

If you smell gas:

Do not try to light any appliance. Do not touch any electrical switch.

Call the Gas Emergency Helpline at TRANSCO on: **0800 111999**

In the Republic of Ireland, call the Bord Gáis emergency line on **1850 205050** or contact your local gas supplier.

Stoves Customer Care

In case of difficulty within the UK and Northern Ireland, please call STOVES Customer Care Centre Helpline on

0151 432 7838

When you dial this number you will hear a recorded message and be given a number of options. This indicates that your call has been accepted and is being held in a queue. Calls are answered in strict rotation as our Customer Care Representatives become available.

Opening Hours for Customer Care Centre

Monday to Friday	8am - 8pm
Saturday	8.30am - 6pm
Sunday	10am - 4pm

Enter appliance numbers here for future reference:

Model No
<input type="text"/>
Serial No
<input type="text"/>

Please ensure you have the above details (Model No and Serial No) to hand when calling Stoves Customer Care. They are essential to booking your call.

Outside the UK and Northern Ireland, refer to your local supplier.

The Gas Consumer Council (GCC) is an independent organisation which protects the interests of gas users. If you need advice, you will find the telephone number in your local telephone directory under Gas.

Technical Data

Data badge; Located on the lower part of the front frame.

Type of gas; This cooker must only be used with either Natural gas or LP gas, as specified on the appliance data badge.

Gas category; Natural gas - I2H, LP gas - I3+

Pressure setting;

G20 Natural Gas @ 20 mbar

G30 Butane @ 28 - 30 mbar

G31 Propane @ 37 mbar

Aeration; Fixed

Electrical supply; 220 - 240V ~ 50Hz

Warning: This cooker must be earthed.

Spark generators; Mains powered 7 outlet, controlled by a single switch at the left of the fascia to individual electrodes.

Hob; Burners have burner heads and caps which are removable for cleaning. Concealed electrodes to each burner.

Appliance class; Class 1, freestanding cooker

Countries of destination; GB - Great Britain, IE - Ireland

Hotplate burner / Element		Nominal Rate Qn	Injector marking	Grammes per hour	
				Butane	Propane
Natural Gas	Hob - small (2)	1.0kW	77	-	-
	Hob - medium (3)	2.0kW	104	-	-
	Hob - large (1)	3.0kW	129	-	-
	Hob - wok (1)	3.5kW	121 & 63	-	-
	Total heat input	ΣQ_n 14.5kW	-	-	-
LP Gas	Hob - small (2)	1.0kW	50	73	72
	Hob - medium (3)	2.0kW	70	145	143
	Hob - large (1)	3.0kW	87	218	215
	Hob - wok (1)	3.50kW	87 & 35	254	250
	Total heat input	ΣQ_n 14.5kW	-	1054	1037
Electric @ 235V	Grill (dual)	2575W	-	-	-
	Grill (single)	1655W	-	-	-
	Conventional oven	1920W	-	-	-
	Fan oven	2300W	-	-	-
	Stir fan	30W	-	-	-
	Cooling fan	10W	-	-	-
	Oven lights (if fitted)	25W each	-	-	-
	Maximum load	6885W			

Contents

User's Section	2 - 19
Introduction	2
Storage compartment	4
To replace an oven light bulb (if fitted)	4
Be Safe - Not Sorry.	5
Using the Hob	6
Using the Griddle (if supplied)	8
Using the Grill	9
Using the Ovens	10
Programmer / Clock	12
Cleaning	16
 Installation Instructions	 19 - 23
Regulations and Standards	19
Ventilation Requirements	19
Installation	20
Connect to Electricity Supply	22
Connect to the Gas Supply	23
Commissioning	23
 Technical Data	 24
 Stoves Customer Care	 25

Please keep this handbook for future reference, or for anyone else who may use the appliance.

Introduction

Thank you for choosing a British built appliance by Stoves

We hope the following information will help you to quickly familiarise yourself with the features of the appliance, and to use it successfully and safely.

Our policy is one of constant development and improvement. Strict accuracy of illustrations and specifications is not guaranteed. Modification to design and materials may be necessary subsequent to publication.

This appliance must be installed in accordance with the regulations in force, and only in a well ventilated space. Read the instructions before installing or using this appliance.

Your appliance is designed to be installed free-standing or flush to base units.

Your 1st Year Guarantee

To fulfil the conditions of your guarantee, this appliance must be correctly installed and operated, in accordance with these instructions, and only be used for normal domestic purposes. Please note that the guarantee, and Service availability, only apply to the UK and Republic of Ireland.

The *User's Section* in this handbook covers the operation of the appliance, but to help you make the most of your cooker, we have produced the accompanying *Cooking Guide* which gives more details of its features and benefits.

Environmental Protection

We are committed to protecting the environment and operate an Environmental Management System which complies with BS EN ISO 14001:1996.

Disposal of packaging

- All our packaging materials are recyclable and environmentally friendly.
- Please help us to protect our environment by disposing of all packaging in an environmentally friendly manner.
- Please contact your local authority for the nearest recycling centre.

Caution: Packaging materials can pose a risk of suffocation - keep away from children.

Gas & Electrical connection

Please refer to installation instructions for the Gas & Electrical Safety Regulations and the Ventilation Requirements.

In your own interest, and that of safety, it is the law that all gas appliances be installed by competent persons. Corgi registered installers undertake to work to satisfactory standards.

Disconnection of gas and electric appliances should always be carried out by competent persons.

Warning: This appliance must be earthed.

Installation Instructions

Connect to the gas supply

The inlet to the cooker is ½" BSP internal situated at the rear centre.

Fit the bayonet connection. This should be located so as to ensure the flexible connector hose does not kink.

Use a 900mm - 1125mm length of flexible connector.

Natural Gas - Flexible connections should comply with BS 669. Parts of the appliance likely to come into contact with a flexible connector have a temperature rise of less than 70°C.

LP Gas - For flexible connections, use a bayonet type hose, suitable for use on LP Gas up to 50 mbar pressure rise and 70°C temperature rise. The flexible hose should be coloured black with a red stripe, band or label. If in doubt, contact your supplier.

After installation, make sure all connections are gas sound.

Important: ensure that you route all mains electrical cables and flexible tubing well clear of any adjacent heat source.

Ensure that all pipework is of the correct rating for both size and temperature.

Commissioning

Burner aeration

All burners have fixed aeration and no adjustment is possible.

Pressure setting

G20 Natural gas @ 20 mbar
G30 Butane @ 28-30 mbar
G31 Propane @ 37 mbar

Ignition

All burners are ignited by pressing the ignition switch on the fascia. When the burner has lit release the ignition switch. Turn the tap to the FULL ON position, wait a second before pressing the ignition switch.

Before leaving the installation

1. Place all the loose parts of the cooker into position.
2. Show the customer how to operate the cooker and give them this handbook.

Thank you.

Installation Instructions

Connect to the electricity supply

Warning: This appliance must be earthed.

The appliance must be installed by a competent electrician using a double pole control unit of 30 ampere minimum capacity with 3mm minimum contact separation at all poles.

We recommend that the appliance is connected by a qualified electrician who is a member of the N.I.C.E.I.C. and who will comply with the I.E.E. and local regulation.

1. Access to the mains terminal is gained by opening the terminal block cover at the rear of the appliance (use a small flat-bladed screwdriver).
2. Connection should be made with 6.0mm² twin and earth cable.
3. First strip the wires, then push the cable through the cable clamp in the terminal block cover.
4. Connect the cable to the terminal block and tighten the cable clamp screw (see diagram).
5. Close the terminal box, ensuring that the cover is engaged on the locking tabs.

Important: ensure that you route all mains and electrical cables well clear of any adjacent heat source.

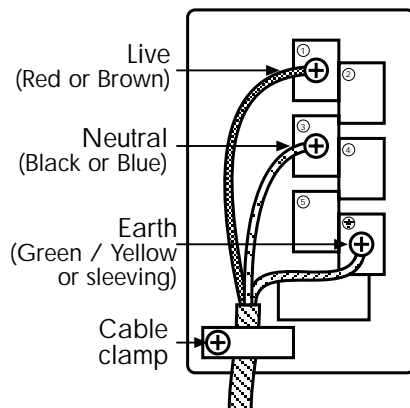

Introduction

Moving the cooker

Do not attempt to move the cooker by pulling on the doors or handles. Open the door and grasp the frame of the cooker, taking care that the door does not shut on your fingers.

Take care to avoid damage to soft or uneven floor coverings when moving the appliance. Some cushioned vinyl floor coverings may not be designed to withstand sliding appliances without marking or damage.

Stability bracket

If the cooker is to be fitted with a flexible inlet connection, a stability bracket should also be fitted to engage in the back of the cooker. Make sure this is re-engaged whenever you move the cooker for cleaning.

Ventilation

The use of a gas cooking appliance results in the production of heat and moisture in the room in which it is installed. Ensure that the kitchen is well ventilated: keep natural ventilation holes open or install a mechanical ventilation device (mechanical extractor hood). Prolonged intensive use of the appliance may call for additional ventilation, for example, opening of a window, or more effective ventilation, for example increasing the level of mechanical ventilation where present.

Glass door panels

To meet the relevant Standards of Domestic cooking appliances, all the glass panels on this appliance are toughened to meet the fragmentation requirements of BS 3193. This ensures that, in the unlikely event that a panel breaks, it does so into small fragments to minimise the risk of injury.

Please take care when handling, using or cleaning all glass panels, as any damage to the surfaces or edges may result in the glass breaking without warning or apparent cause at a later date. Should any glass panel be damaged, we strongly recommend that it is replaced immediately.

If the ignition fails:

- Check there is a spark when the ignition button is depressed.
- If there is no spark, check that the electricity supply is switched on at the socket.
- Check that the gas supply is switched on.

Before using the appliance for the first time, remove any protective polythene film and wash the oven shelves and furniture in hot soapy water, to remove their protective coating of oil. Even so, when you first turn on the oven or grill you may notice a smell and some smoke.

Introduction

Storage compartment

Your appliance has a generous storage compartment, located beneath the right-hand side oven.

The storage compartment should only be used to store oven furniture.

Baking trays and roasting tins may be stored in the compartment.

Do not store items with plastic or wooden handles in the compartment, as they may be damaged by heat from the oven.

Do not store flammable liquids, even when cold, in the storage compartment, as they may catch fire. Do not store flammable items - ie; chip pans.

Do not store food / canned items in the storage compartment. **Do not use the compartment as a food warming facility.**

To replace an oven light bulb (if fitted)

Caution: Switch off the electricity supply to the appliance at the socket, and wait until the oven is **cool** before removing the oven shelves.

Grasp the lens cover on the light fitting and pull it away from the side of the oven. Unscrew the bulb.

Please note that the oven light bulb is not covered by the guarantee. Replacement bulbs can be ordered from your local supplier, or bought from a hardware store.

Installation Instructions

Stability bracket

If the cooker is fitted with a flexible connection, a stability bracket should be fitted to engage in the back of the cooker. A stability bracket can be bought from your local supplier.

A stability bracket can be fitted as follows:

1. Place the cooker in position and draw a PENCIL LINE level with the front edge.
2. Mark the centre of the cooker to give the CENTRE LINE for the bracket.
3. Remove the cooker and mark off 450mm from the PENCIL LINE to locate the front edge of the lower bracket.

4. Fix the bracket to the floor.
Measure from floor level to engagement edge in the back of the cooker and add 3mm.
5. Assemble the underside of the top part of the bracket to this height.

Levelling

Place a spirit level on a baking sheet onto an oven shelf.

The cooker is fitted with levelling feet and locknuts at the front, and wheels at the rear.

Adjustment of wheel height can be made with a screwdriver through the hexagonal hole in the front plinth.

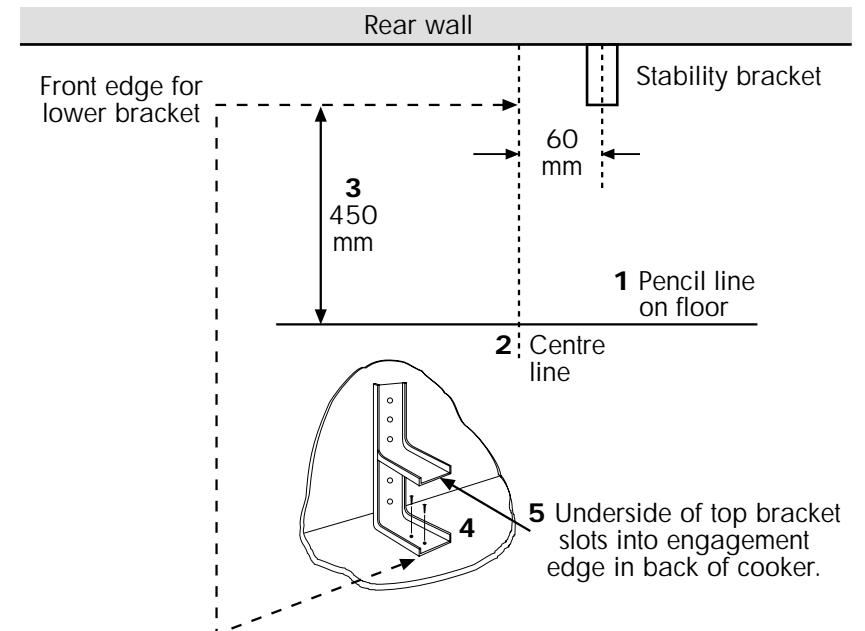

Installation Instructions

Before you start, please read the instructions. Planning your installation will save you time and effort.

Moving the cooker

Please note that the weight of this appliance is approximately 89kg (unpacked). Take care if the appliance needs to be lifted during installation - always use an appropriate method of lifting.

Do not attempt to move the cooker by pulling on the doors or handles. Open the door and grasp the frame of the cooker, taking care that the door does not shut on your fingers.

Take care to avoid damage to soft or uneven floor coverings when moving the appliance. Some cushioned vinyl floor coverings may not be designed to withstand sliding appliances without marking or damage.

Cooker dimensions

All sizes are nominal, and some variation is to be expected. The 'depth' of the cooker, as given below, is to the front of the door and excluding knobs and handles.

height (adjustable);
with lid down - 900 - 915mm
with lid up - 1430 - 1445mm
width; 1100mm
depth; 600mm

Whilst every care is taken to eliminate burrs and raw edges from this product, please take care when handling - we recommend the use of protective gloves during installation.

Clearances

No shelf or overhang or cooker hood shall be closer than a minimum of 650mm, but check with cooker hood manufacturer's recommendations.

The cooker must have a side clearance above hob level of 90mm up to a height of 400mm.

This cooker may be fitted flush to base units up to the front edge of the side panels.

For models with side opening doors, we recommend a side clearance of 60mm between the cooker and any protruding side wall or cabinet, to allow the door to open fully.

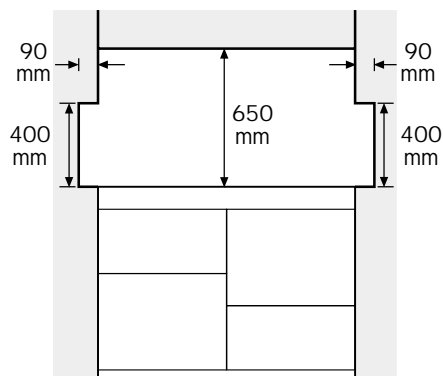

Be Safe - Not Sorry

When you are cooking, keep children away from the vicinity of the appliance.

This product is designed as a domestic cooking appliance for the preparation and cooking of domestic food products, and should not be used for any other purpose.

- Remove all packaging from the appliance before using for the first time.
- Make sure you read and understand the instructions before using the appliance.
- Keep electrical leads short so they do not drape over the appliance or the edge of the worktop.
- Keep all flammable materials (such as curtains, furnishings & clothing) away from the appliance.
- Parts of the appliance may be hot during or immediately after use. Care should be taken to avoid touching heating elements inside the oven. Allow sufficient time for the appliance to cool after switching off.
- Do not drape tea towels over the flue vents or doors, as this creates a fire hazard.
- When opening the appliance door, take care to avoid skin contact with any steam which may escape from the cooking.

- Do not use aluminium foil to cover the grill pan, or put items wrapped in foil under the grill, as this creates a fire hazard.
- Use oven gloves when removing hot food / dishes from the oven or grill. The oven / grill and utensils will be very hot when in use.
- Do not use foil on oven shelves or allow it to block the oven flue, as this creates a fire hazard, and prevents heat circulation.
- When cooking heavy items - eg; turkeys - do not pull the oven shelf out with the item still on the shelf.
- The storage compartment should only be used to store oven furniture. Do not store any flammable materials in this compartment.
- Always allow the griddle (if supplied) to cool before removing it for cleaning.
- Never use the appliance for heating a room.

As with all gas appliances, it is recommended that your appliance is serviced regularly.

When you have finished cooking check that all controls are in the off position.

Using the Hob

Ignition

Open the glass hotplate lid (if fitted).

Push in and turn the selected hotplate control knob anticlockwise to the *large flame* symbol and press the IGNITION SWITCH until the burner lights. Turn the control knob to the required setting.

Adjust the burner flame so that it does not extend over the pan base.

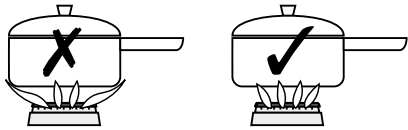

To turn off, push in the control knob and turn clockwise until the dot on the control knob is below the line on the fascia panel.

To simmer

The simmer position is marked by the *small flame* symbol.

Once lit turn the selected control knob anticlockwise past the *large flame* symbol ("FULL ON") to the *small flame* symbol.

You may hear a slight popping noise when the hob burners are operating and this is quite normal, but if anything about the cooker appears unusual, such as change in flame appearance, or the operation of controls - seek expert advice.

The fold down lid (if fitted)

Caution: Glass lids may shatter when heated. Turn off all the burners before shutting the lid.

Any spillage should be removed from the surface of the lid before opening.

When opening and closing the lid, use the cooler outer sides of the lid trim.

The lid must be opened fully, so there is no danger of it closing while the hob is being used.

The appliance is fitted with a switch-back system, which will automatically turn off the hotplate controls if they are inadvertently left on as the lid is closed.

The lid is not intended to be used as a work surface, as it becomes hot when any part of the cooker is in use, and the surface may be scratched if items with rough or sharp surfaces are placed on it.

Installation Instructions

Before you start: Please read the instructions. Planning your installation will save you time and effort.

Prior to installation, ensure that the local distribution conditions (nature of the gas and gas pressure) and the adjustment of the appliance are compatible. The adjustment conditions are stated on the data badge.

This appliance is not connected to a combustion evacuation device. It shall be installed and connected in accordance with current installation regulation. Particular attention shall be given to the relevant requirements regarding ventilation.

In your own interest and that of safety, it is the law that all gas appliances be installed and serviced by competent persons. CORGI registered installers undertake to work to satisfactory standards.

Where regulations or standards have been revised since this handbook was printed, always use the latest edition.

In the UK the regulations and standards are as follows:

1. Gas Safety Regulations 1996 (Installation and Use).
2. Building Regulations - Issued by the Department of the Environment.
3. Building Standards (Scotland) (Consolidated) - Issued by the Scottish Development Department.
4. The current I.E.E. Wiring Regulations.
5. Electricity at Work Regulations 1989.
6. BS 6172 Installation of Domestic Gas cooking Appliances

Also, for **LP Gas**, refer to BS 5482 Part 1, Part 2 or part 3 as relevant.

7. Installation & Servicing Instructions for this appliance.

For installation in countries other than the UK, the appliance must be connected in accordance with all local gas and electrical regulations. In the Republic of Ireland, Installers should refer to IS813 Domestic Gas Appliances.

Ventilation Requirements

The room containing the appliance should have an air supply in accordance with BS 5440: Part 2: 1989:

- All rooms require an openable window, or equivalent, and some rooms will require a permanent vent as well.
- For room volumes up to 5m³ an air vent of 100cm² is required.
- If the room has a door that opens directly to the outside, or the room exceeds 10m³, NO AIR VENT is required.
- For room volumes between 5m³ and 10m³ an air vent of 50cm² is required.
- If there are other fuel burning appliances in the same room, BS 5440: Part 2: 1989 should be consulted to determine the air vent requirements.
- This appliance must not be installed in a bed sitting room of less than 20m³ or in a bathroom or shower room.

Windows and permanent vents should therefore not be blocked or removed without first consulting a CORGI gas installer.

LP Gas only - Do not install this appliance in a room below ground level. This does not preclude installation into rooms which are basements with respect to one side of the building, but open to ground level on the opposite side.

In the Republic of Ireland, refer to relevant Irish Standards for correct ventilation requirements.

Failure to install appliances correctly is dangerous and could lead to prosecution.

Cleaning

Burner caps & heads

Important: Allow the burners to cool before cleaning.

Caution: Hotplate burners can be damaged by soaking, automatic dishwashers (or dishwasher powders / liquids), caustic pastes, hard implements, coarse wire wool, and abrasive cleaning pastes.

Burner heads are aluminium. Clean with a moist soapy pad - eg; "Brillo".

For the burners to work safely, the slots in the burner head where the flames burn need to be kept clear of deposit. Clean with a nylon brush, rinse, and dry thoroughly.

Important: The burner caps and heads must be repositioned correctly so that they sit properly on the hob as shown below.

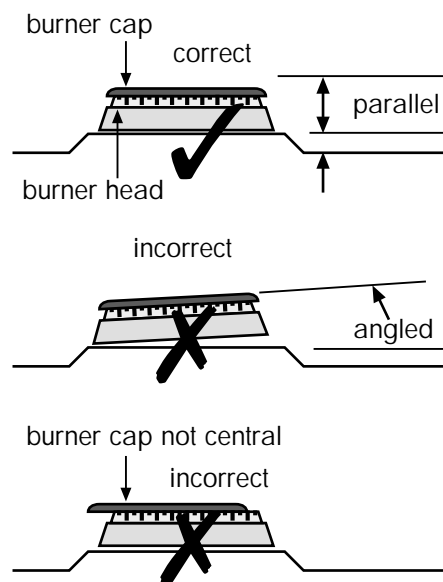

Using the Hob

Pans

For optimum safety and performance, we recommend the use of flat bottomed pans with a base diameter of minimum 100mm (4") and maximum 250mm (10").

Turn pan handles to a safe position so they are out of reach of children, not overhanging the appliance, and cannot be caught accidentally.

Use pans with a flat base which are stable in use, and avoid using any old misshapen pans or any pan which is unstable when placed on a flat surface.

Position pans over the centre of the burners, resting on the pan supports. If positioned off centre, smaller pans may be unstable.

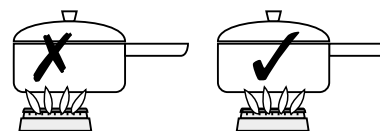

When cooking with fat or oil, never leave unattended.

Commercial simmering aids should not be used as they create excessive temperatures that can damage the surface and may cause a hazard.

Pan supports

Make sure that you use the correct-shaped pan support for the burner you wish to use.

The wok burner has a different shaped pan support to the other hotplate burners. The wok burner must only be used with this pan support.

Always make sure the pan supports are replaced correctly, and located in the hob spillage well.

Burner	suitable for:
Small (2)	<i>Simmering, stewing, smaller pans.</i>
Medium (3)	<i>General domestic use, large frying pans, chip pans, griddle cooking.</i>
Large (1)	<i>Boiling, frying, larger pans.</i>
Wok (1)	<i>Wok cooking, larger pans.</i>

Using the Griddle (if supplied)

Caution: Accessible parts may be hot when the griddle is used. Young children should be kept away.



Griddle symbol

Please read these instructions thoroughly before using the griddle plate for the first time.

Only use the griddle which has been approved for use on this appliance. Do not use any other griddle, as this may be hazardous.

For instructions on griddle cooking, please refer to the accompanying cooking guide.

Before using the griddle for the first time

Wash the griddle thoroughly in hot soapy water (see "Cleaning" section). Season sparingly with a minimum amount of cooking oil (see below).

Heat the griddle on full rate for 3 minutes. The griddle plate is now ready for use.

Seasoning the griddle

The griddle is made of quality cast iron, and has a non-stick cooking surface.

Regular seasoning will prolong the life of the griddle and prevent rusting. If the griddle shows signs of rust, wash and re-season.

To season;

- After cleaning, dry the griddle thoroughly.
- Rub the cooking side of the griddle sparingly with a minimum amount of unsalted vegetable oil. Note that olive oil is unsuitable for seasoning.

Using the griddle

The griddle should only be used with the small and medium sized burners on the right-hand side of the hotplate, as indicated by the griddle symbol on the fascia panel. Do not use the griddle over large burners or wok burners, or over the left-hand side small and medium burners.

Place the griddle carefully on the pan support over the burners, using the locating feet on the underside of the griddle. Take care to avoid damage to the vitreous enamel surface of the pan supports.

Before cooking, preheat the griddle for 3 minutes on full rate, which is indicated on the control knobs by a large flame symbol.

After preheating, turn the control knobs to the small flame symbol.

The griddle is now ready for cooking.

Do not use metal implements, as they may damage the non-stick surface.

After cooking, allow the griddle to cool before moving or cleaning it.

Cleaning

Painted, plastic, metal finish & metal finish parts (where fitted)

CONTROL KNOBS & PROGRAMMER BUTTONS, PAINTED METAL DOOR & FASCIA PANELS, SIDE PANELS, HANDLES, GRILL PAN HANDLE

Only use a clean cloth wrung out in hot soapy water. Take extra care when cleaning over symbols on fascia panels.

Glass parts

GLASS DOOR PANELS, GLASS LID (if fitted)

Only use a clean cloth wrung out in hot soapy water, or "Hob Brite", by Homecare*. Rinse away any excess cleaner and dry with a soft cloth.

Do not use abrasives or polishes as they will scratch and damage the glass.

Glass door panels:

Warning: Do not operate the appliance without the glass panel correctly fitted.

Important: the inner door glass panel can be removed for cleaning but it must be replaced the right way up (so the reflective side - if fitted - faces inwards), and pushed fully in to the stop position. To remove the glass panel, open the door wide, hold the top and bottom edges and slide out.

Cast iron griddle (if supplied)

Do not use metal implements when cooking, as they may damage the non-stick surface.

After cooking allow the griddle to cool completely before attempting to remove or clean.

Once the griddle has cooled, remove any excess fat with kitchen paper before moving.

The griddle can be cleaned with hot soapy water and a nylon brush. If any food residue is left on the griddle, leave it to soak for a few minutes in hot soapy water before attempting to clean it. Do not use caustic pastes, abrasive cleaning powders, coarse wire wool or any hard implements, as they will damage the surface.

Do not clean in a dishwasher.

After cleaning, dry thoroughly then re-season the cooking surface by wiping sparingly with a minimum amount of unsalted vegetable oil, and store in a dry place. Note that olive oil is unsuitable for seasoning.

* Homecare products are available mail order from ☎ 0208 871 5027.

Cleaning

Caution: Any cleaning agent used incorrectly may damage the appliance.

Always let the appliance cool before cleaning.

Some cooking operations generate considerable amounts of grease - this, combined with spillage, can become a hazard if allowed to accumulate on the appliance through lack of cleaning. In extreme cases this may amount to misuse of the appliance and could invalidate your guarantee.

Do not use caustic, corrosive or abrasive cleaning products, products containing bleach, coarse wire wool or any hard implements, as they will damage the surfaces.

It is recommended that the appliance is cleaned after open roasting.

All user-accessible parts of the appliance can be safely cleaned with a clean cloth wrung out in hot soapy water.

Vitreous Enamel parts

GRILL PAN, GRILL COMPARTMENT, HOB TOP, PAN SUPPORTS & BURNER CAPS, OVEN COMPARTMENT FLOOR

Use a mild cream cleaner - eg; "Cif". Stubborn marks may be removed with a moistened "Brillo" pad.

The pan supports and grill pan may be cleaned in a dishwasher, or with a nylon brush in hot soapy water.

Chrome plated parts

OVEN SHELVES & SHELF RUNNERS, GRILL PAN TRIVET

Do not use abrasives or polishes, use a moist soap pad - eg; "Brillo".

Note: Oven shelf runners can be removed for cleaning. Grasp the runners, and slide out of the hanging holes as shown.

Note: These items may also be cleaned in a dishwasher.

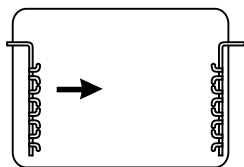

Easy care surfaces (if fitted)

OVEN SIDES AND BACK

We recommend that the appliance is cleaned after open roasting, and also after roasting at temperatures higher than 200°C, to help prevent a build up of fats. Use of a trivet in a roasting tin when roasting will help reduce fat splashing.

Caution: Most types of cleaning agent will damage these surfaces.

Only use a few drops of washing up liquid in hot water. Wipe the surfaces with a clean cloth wrung out in hot soapy water - if larger splashes of fat do not readily disappear, scrub the area with a nylon brush or nylon pan scourer and hot soapy water. Rinse well and heat the oven to dry the surfaces.

Using the Grill

Caution: Accessible parts may be hot when the grill is used. Young children should be kept away.

The grill is a variable electric dual grill.

To switch on the grill

Open the grill door.

Turn the grill control knob either clockwise to use the full grill settings, or anti-clockwise to the economy grill settings.

The economy grill settings only use the inner element of the grill.

Important: Keep the grill door open when the grill is on.

To switch off, return the control knob to the "off" position.

Preheating

For best cooked results, always preheat the grill for about 3 minutes.

The cooling fan

When the grill is switched on, you will hear the cooling fan come on - this keeps the fascia and control knobs of the appliance cool during grilling only. The fan will continue to operate for a period after the grill control has been switched off. Should any fault occur with the cooling fan, the appliance will require servicing - contact Customer Support.

Detachable grill pan handle

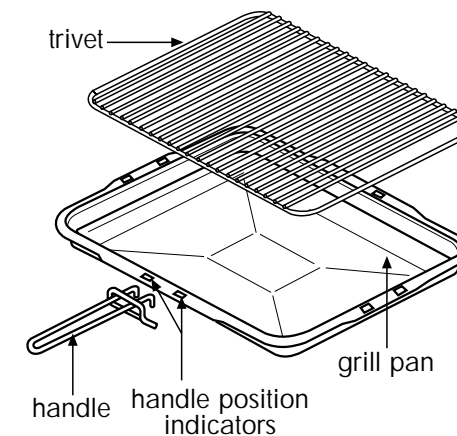

Place the handle over the edge of the grill pan, at the narrow side edges. Slide the handle to the centre, and locate between the handle position indicators.

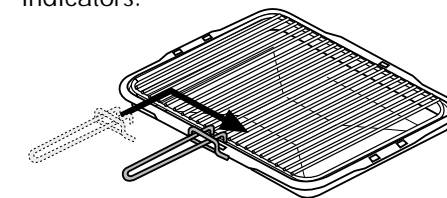

The handle should be removed from the pan during grilling, to prevent overheating.

The handle is designed for removing / inserting the grill pan under the grill when grilling.

If cleaning the grill pan when it is hot, use oven gloves to move it. **Do not** use the handle to pour hot fats from the grill pan.

Food for grilling should be positioned centrally on the trivet.

Using the Grill

Using the grill

The temperature of the grill is variable, and can be adjusted by turning the grill control to the required setting. Setting 8 is high and 1 is low.

Turn the grill control knob either clockwise to use the full grill settings, or anticlockwise to the economy grill settings.

The economy grill settings only use the inner element of the grill.

The speed of grilling can also be controlled by selecting a higher or lower shelf position.

It is recommended that the high temperature setting is used for toasting and for cooking foods such as bacon, sausages or steaks. Use a higher shelf position.

For thicker foods such as chops or chicken joint pieces, the temperature may be reduced to a lower setting. Use a lower shelf position.

Grilling can also be adjusted by adjusting the trivet position, as detailed below;

- The grill trivet inside the grill pan can be inverted to give a high or low position, or it may be removed altogether.
- For toasting, use the highest trivet position.
- The lower trivet position is useful for grilling all types of meat or fish.
- With trivet removed the food is placed directly on the base of the

grill pan - eg; when cooking whole fish, or browning dishes such as cauliflower cheese.

Push the grill pan to the back of the shelf, to position it under the centre of the grill.

Never allow fat to build up in the grill pan, as this creates a fire hazard.

For best results, preheat the grill for 3 - 5 minutes before use.

When you have finished grilling, check that the control knob is returned to the "off" position.

Aluminium foil

Using aluminium foil to cover the grill pan, or putting items wrapped in foil under the grill, creates a fire hazard, and the high reflectivity may damage the grill element.

Programmer / Clock

The oven will automatically switch off at 18.00 hours (6.00 pm) and the alarm will sound (9).

To switch off the alarm press the *minute minder* button (10).

When the oven has switched off, **return the oven control knob to the "off" position**, and press the *cook time* and *ready time* buttons simultaneously (11).

If you wish to cancel the automatic setting before cooking has started, and return to manual operation, press the *cook time* and *ready time* buttons simultaneously (11).

To cancel any remaining cooking time left on the clock before the alarm sounds, press the *cook time* and *ready time* buttons simultaneously (11).

9. A (Auto) symbol will flash.

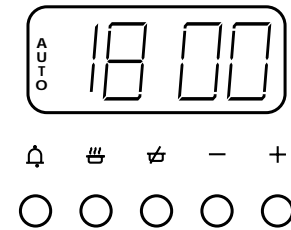

10.

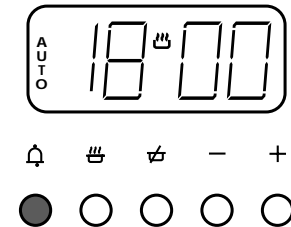

11. A (Auto) symbol goes out.

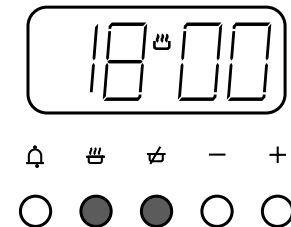

Programmer / Clock

Fully automatic cooking (example)

For use when a delayed start time is required.

You want to set the length of cooking time, and the time for the oven to switch off. The programmer will automatically calculate the cooking start time.

Press the *cook time* button, then use the *plus* and *minus* buttons to set the display to show the length of cooking time required, eg; 2 hours as shown (5).

Press the *ready time* button, and the present ready time will be displayed. Using the *plus* and *minus* buttons you can set the display to show the actual time you want the oven to switch off, eg; 18.00 hours (6.00 pm) (6).

The display will revert to show time of day.

After setting the programmer, turn the oven control to the required temperature.

The oven will automatically switch on at the calculated start time of 16.00 hours (4.00 pm) (7).

A single press of the *cook time* button shows the cooking time remaining before the oven automatically switches off (8).

5. A (Auto) symbol appears.

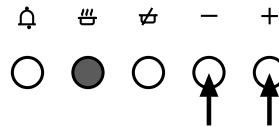

6. The cookpot symbol will disappear from display.

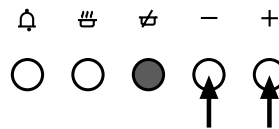

7. The cookpot symbol will appear on display.

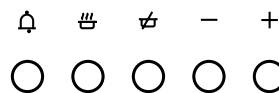

8.

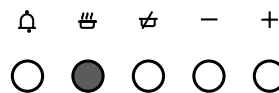

Using the Oven

Caution: Accessible parts may be hot when the appliance is in use. Young children should be kept away.

The cooker has two electric ovens.

Please refer to the accompanying cooking guide for further instructions on using the ovens.

Right-hand side Fanned oven

The right-hand side oven is a fanned electric oven. It may be controlled by the automatic programmer.

To switch on, turn the oven control knob clockwise to the desired temperature setting.

To switch off, return the control knob to the "off" position.

Left-hand side Conventional oven

The left-hand side oven is a conventional electric oven. This oven is not controlled by the automatic programmer.

To switch on, turn the oven control knob clockwise to the desired temperature setting.

To switch off, return the control knob to the "off" position.

Caution: The top element gets extremely hot when in use, so take care to avoid touching it.

Important: Never put items directly on the base of the oven or cover the oven base with foil, as this may cause the element to overheat.

Baking tray and roasting tins

For best cooked results and even browning, the maximum size baking trays and roasting tins that should be used are as follows;

Baking tray 290mm x 270mm

This size of baking tray will hold up to 16 small cakes.

Roasting tin 320mm x 270mm

We recommend that you use good quality cookware. Poor quality trays and tins may warp when heated, leading to uneven baking results.

Oven shelves

The oven shelf must be positioned with the upstand at the rear of the oven and facing upwards.

Position baking trays and roasting tins on the middle of the shelves, and leave one clear shelf position between shelves, to allow for circulation of heat.

Notes:

As part of the cooking process, hot air is expelled through a vent at the top of the oven(s). When opening the oven door, care should be taken to avoid any possible contact with potentially hot air, since this may cause discomfort to people with sensitive skin. We recommend that you hold the underneath of the oven door handle.

If you find that, over a period of time, the oven becomes hotter when used at a particular temperature, the thermostat may need to be replaced.

Programmer / Clock

The Programmer Buttons

- 🔔 minute minder
- 🕒 cook time
- 🕒 ready time
- minus
- + plus

To set the "Time of Day"

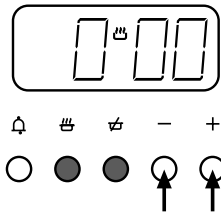

Press the *cook time* and *ready time* buttons simultaneously, and keep the buttons depressed. Use the *plus* and *minus* buttons to set the time of day, eg; 12.00.

A (Auto) symbol goes out, cookpot symbol comes on.

To select an alarm tone

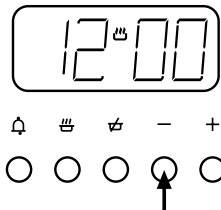

Press the *minus* button to listen to the first tone.

Release the *minus* button and press it again to listen to the second tone, etc.

Releasing the *minus* button after the tone has sounded will automatically select that tone.

Manual operation



To set the programmer to manual operation at any time (cancelling any automatic setting), press the *cook time* and *ready time* buttons simultaneously. The programmer must be set to manual before the appliance can be used manually.

Setting the minute minder

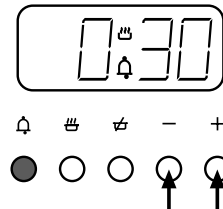

Press the *minute minder* button, then use the *plus* and *minus* buttons to set the required time.

The minute minder (bell) symbol will appear on the display.

You can cancel the minute minder at any time by pressing the *minute minder* button and the *minus* button until the display returns to 0.00.

After setting, the display will revert to show the time of day, but you can press the *minute minder* button, and the display will show the minutes remaining.

The tone will sound at the end of the time set - to cancel the tone, press the minute minder button.

Programmer / Clock

Semi-automatic cooking (example)

You have started cooking a meal or dish in the oven, and want to set the time for the oven to switch off.

Press the *cook time* button, then use the *plus* and *minus* buttons to set the display to show the length of cooking time required, eg; 2 hours as shown (1).

After setting, the display will revert to show the time of day, but you can press the *cook time* button and the display will show how much cooking time still remains on the clock.

Press the *ready time* button, and the display will show the actual time the oven is going to switch off, eg; 18.00 as shown (2).

At the end of the cooking time, the alarm will sound, and the oven will automatically switch off.

To switch off the alarm, press the *minute minder* button (3).

When the oven has switched off, **return the oven control knob to the "off" position**, and press the *cook time* and *ready time* buttons to return to manual operation (4).

If you wish to cancel the automatic setting, or to cancel any remaining cooking time left on the clock before the alarm sounds, press the *cook time* and *ready time* buttons simultaneously. (4).

1. A (Auto) symbol appears.

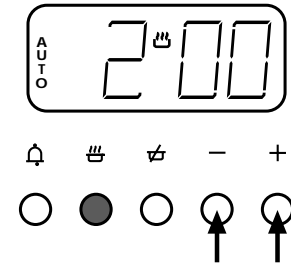

2.

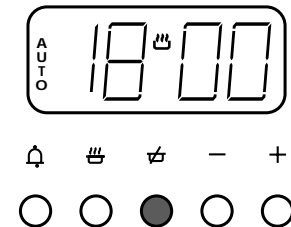

3. A (Auto) symbol will flash.

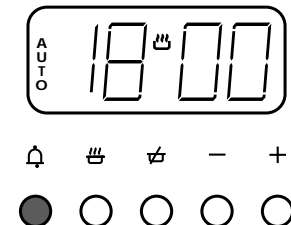

4. A (Auto) symbol goes out.

