

900DFa

Dual Fuel Professional Range Cooker

For Natural Gas models & LP Gas models

User & Installation Instructions

STOVES™

Stoney Lane, Prescot, Merseyside, L35 2XW

STOVES CUSTOMER CARE

In case of difficulty within the UK and Northern Ireland, please call
Stoves Customer Care Centre Helpline on

0151 432 7838

When you dial this number you will hear a recorded message and be given a number of options. This indicates that your call has been accepted and is being held in a queue. Calls are answered in strict rotation as our Customer Care Representatives become available.

Opening Hours for Customer Care Centre

Monday to Friday	8am - 8pm
Saturday	8.30am - 6pm
Sunday	10am - 4pm

Enter appliance numbers here for future reference:

Model No
<input type="text"/>
Serial No
<input type="text"/>

Please ensure you have the above details (Model No and Serial No) to hand when calling Stoves Customer Care. They are essential to booking your call.

Outside the UK and Northern Ireland, refer to your local supplier.

CONTENTS

User's Section	2 - 23
Introduction	2
Be Safe - Not Sorry.	5
Oven & Grill functions.	6
Storage Compartment	8
Using the Hob	9
Hotplate Accessories (if supplied)	11
Using the Grill	12
Using the Oven	14
Programmer / Clock	17
Cleaning.	21
Installation Instructions.	24 - 29
Regulations and Standards.	24
Ventilation Requirements	24
Clearances & Dimensions	25
Stability bracket & Levelling	26
Connect to the gas supply	27
Connect to electricity supply	28
Fitting the door handle	29
Commissioning.	29
Conversion instructions	30
Technical Data	31
Stoves Customer Care	32

If you smell gas:

Do not try to light any appliance. Do not touch any electrical switch.

Call the Gas Emergency Helpline at TRANSCO on: **0800 111999**

In the Republic of Ireland, call the Bord Gais emergency line on
1850 205050 or contact your local gas supplier.

Please keep this handbook for future reference, or for anyone else who may use the appliance.

INTRODUCTION

Thank you for choosing a British built appliance by Stoves

We hope the following information will help you to quickly familiarise yourself with the features of the appliance, and to use it successfully and safely.

Our policy is one of constant development and improvement. Strict accuracy of illustrations and specifications is not guaranteed. Modification to design and materials may be necessary subsequent to publication.

This appliance must be installed in accordance with the regulations in force, and only in a well ventilated space. Read the instructions before installing or using this appliance.

This appliance is designed to be installed free-standing or flush to base units.

Your 1st Year Guarantee

To fulfil the conditions of your guarantee, this appliance must be correctly installed and operated, in accordance with these instructions, and only be used for normal domestic purposes.

Please note that the guarantee, and Service availability, only apply to the UK and Republic of Ireland.

Before using the appliance for the first time, remove any protective polythene film and wash the oven shelves and furniture in hot soapy water, to remove their protective coating of oil. Even so, when you first turn on the oven or grill you may notice a smell and some smoke.

The *User's Section* in this handbook covers the operation of the appliance, but to help you make the most of your cooker, we have produced the accompanying *Cooking Guide* which gives more details of its features and benefits.

The *Gas Consumer Council (GCC)* is an independent organisation which protects the interests of gas users. If you need advice, you will find the telephone number in your local telephone directory under Gas.

TECHNICAL DATA

Data badge

Located on the lower part of the front frame.

Type of gas

This cooker must only be used with either Natural Gas only or LP Gas only, as specified on the appliance data badge.

Gas category

Natural Gas - I2H, LP Gas - I3+

Pressure setting

G20 Natural gas @ 20 mbar

G30 Butane @ 28 - 30 mbar

G31 Propane @ 37 mbar

Aeration

Fixed

Appliance class

Class 1, freestanding

Electrical supply

230 - 240V ~ 50Hz

Warning: This cooker must be earthed.

Spark generators

Mains powered 6 outlet, controlled by a single switch at the right of the fascia to individual electrodes.

Hob

Burners have burner heads and caps which are removable for cleaning.

Concealed electrodes to each burner.

Electrical ratings

Fan oven element	2400W
Top element	960W
Base element	2 x 835W
Grill	1725 / 2685W
Stir fan	30W
Lights	50W
Cooling fan	23W

Maximum load 2760W

Countries of destination

(GB) Great Britain, (IE) Ireland

Hotplate burner	Nominal Rate Qn	Injector marking	Grammes per hour	
			Butane	Propane
Natural Gas Auxiliary burner	1.0kW	72 X	-	-
Semi rapid burner (x2)	2.0kW	100 Z	-	-
Rapid burner	2.9kW	1.1 Y	-	-
Wok burner	3.3kW	1.24 Y	-	-
Total Heat Input	ΣQn 10.2kW	-	-	-
LP Gas Auxiliary burner	1.0kW	50	73 g/h	72 g/h
Semi rapid burner (x2)	2.0kW	70	145 g/h	143 g/h
Rapid burner	2.9kW	85	211 g/h	207 g/h
Wok burner	3.3kW	90	240 g/h	236 g/h
Total Heat Input	ΣQn 10.2kW	-	814 g/h	801 g/h

INSTALLATION INSTRUCTIONS

Conversion instructions

Natural Gas (I_{2H}) G20 @ 20mbar to
LPG (I₃₊) G30 @ 28mbar / G31 @ 37mbar

1. To convert hotplate burners

- a. Remove pan supports.
- b. Remove burner caps & burner heads.
- c. Unscrew existing injectors from hotplate burner bowls.
- d. Replace with injectors in conversion kit as detailed above.

2. To convert hotplate bypass pins

Before carrying out this procedure ensure that the appliance is disconnected from gas and electrical supplies.

- a. Remove pan supports.
- b. Remove burner caps and heads.
- c. Remove the control knobs and timer buttons from the fascia panel.
- d. Unscrew and remove the fascia panel fixing screws located beneath the fascia panel and gently lower the fascia panel. Remove the ignition and light switch leads from the back of the switches.
- e. The hotplate bypass pins are now accessible through the inner fascia panel. Unscrew each pin and replace as detailed above.

3. Data labels

After completing the above procedure affix label (A), supplied with the conversion kit and remove the label currently fitted, label (B).

label (A): PER / FOR G30/G31

label (B): PER / FOR G20.

INTRODUCTION

Moving the cooker

Do not attempt to move the cooker by pulling on the doors or handles. Open the door and grasp the frame of the cooker, taking care that the door does not shut on your fingers.

Take care to avoid damage to soft or uneven floor coverings when moving the appliance. Some cushioned vinyl floor coverings may not be designed to withstand sliding appliances without marking or damage.

Stability bracket

If the cooker is to be fitted with a flexible inlet connection, a stability bracket should also be fitted to engage in the back of the cooker. Make sure this is re-engaged whenever you move the cooker for cleaning.

Ventilation

The use of a gas cooking appliance results in the production of heat and moisture in the room in which it is installed. Ensure that the kitchen is well ventilated: keep natural ventilation holes open or install a mechanical ventilation device (mechanical extractor hood). Prolonged intensive use of the appliance may call for additional ventilation, for example, opening of a window, or more effective ventilation, for example increasing the level of mechanical ventilation where present.

Gas & Electrical connection

Please refer to installation instructions for the Gas & Electrical Safety Regulations and the Ventilation Requirements.

In your own interest, and that of safety, it is the law that all gas appliances be installed by competent persons. Corgi registered installers undertake to work to satisfactory standards.

Disconnection of gas and electric appliances should always be carried out by competent persons.

Warning: This appliance must be earthed.

Glass door panels

To meet the relevant Standards of Domestic cooking appliances, all the glass panels on this appliance are toughened to meet the fragmentation requirements of BS3193. This ensures that, in the unlikely event that a panel breaks, it does so into small fragments to minimise the risk of injury.

Please take care when handling, using or cleaning all glass panels as any damage to the surfaces or edges may result in the glass breaking without warning or apparent cause at a later date. Should any glass panel be damaged, Stoves strongly recommend that it is replaced immediately.

INTRODUCTION

If the ignition fails

- Check there is a spark when the ignition button is depressed.
- If there is no spark, check that the electricity supply is switched on at the socket.
- Check that the gas supply is switched on.

To replace an oven light bulb

Caution: Switch off the electricity supply to the appliance at the socket, to avoid the risk of electric shock.

Wait until the oven is **cool**, then remove the oven shelves.

Grasp the lens cover on the light fitting and pull it away from the side of the oven. Unscrew the bulb.

Please note that the oven light bulb is not covered by the guarantee. Replacement bulbs can be ordered from your local supplier, or bought from a hardware store.

Environmental Protection

We are committed to protecting the environment and operate an Environmental Management System which complies with BS EN ISO 14001:1996.

Disposal of packaging

- All our packaging materials are recyclable and environmentally friendly.
- Please help us to protect our environment by disposing of all packaging in an environmentally friendly manner.
- Please contact your local authority for the nearest recycling centre.

Caution: Packaging materials can pose a risk of suffocation - keep away from children.

INSTALLATION INSTRUCTIONS

Step 4: Fitting door handle

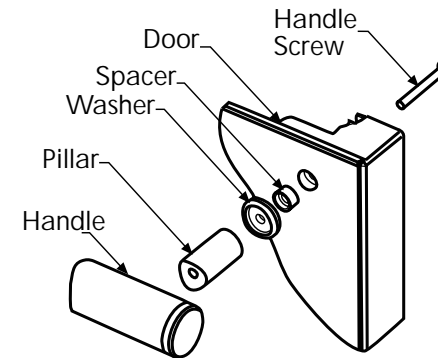

1. Remove handle screws from assembly.
2. Place screws through door.
3. Place spacer, washer and pillar over screw.
4. Screw handle in place. Take care not to over tighten.

Important: DO NOT lift the appliance by the door handle.

Step 5: Commissioning

Burner aeration

All burners have fixed aeration and no adjustment is possible.

Pressure setting

G20 Natural Gas @ 20 mbar
G30 Butane @ 28 - 30 mbar
G31 Propane @ 37 mbar

Ignition

All burners are ignited by pressing the ignition switch on the fascia. When the burner has lit release the ignition switch. Turn the tap to the FULL ON position, wait a second before pressing the ignition switch.

Before leaving the installation

1. Place all the loose parts of the cooker into position.
2. Show the customer how to operate the cooker and give them this handbook.

Thank you.

INSTALLATION INSTRUCTIONS

Step 3: Connect to the electricity supply

Warning: This appliance must be earthed.

The flexible mains lead is supplied connected to a BS1363 fused plug, having a fuse of 13 amp capacity.

If this plug does not fit the socket in your home, it should be replaced with a suitable plug as outlined below.

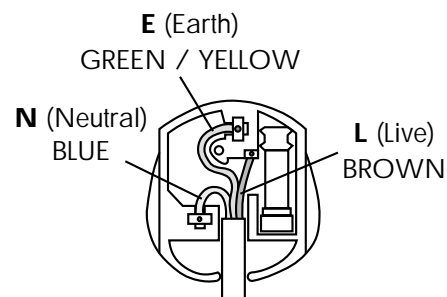

Use a **13 amp** fuse in a 13 amp plug.

The wires in the mains lead are coloured in accordance with the following code:

Green and yellow = Earth

Blue = Neutral

Brown = Live

As the colours of the wires in the mains lead for the appliance may not correspond with the coloured markings identifying the terminals in your plug, proceed as follows:

1. The wire which is coloured green and yellow must be connected to the terminal marked **E** (Earth) or coloured Green.
2. The wire which is coloured blue must be connected to the terminal marked **N** (Neutral), or coloured Black.
3. The wire which is coloured brown must be connected to the terminal marked **L** (Live), or coloured Red.

The plug and socket must be accessible after installation.

Should the appliance mains lead ever require replacing, we recommend that this is carried out by a qualified electrician who will replace it with a lead of the same size and temperature rating.

BE SAFE - NOT SORRY

When you are cooking, keep children away from the vicinity of the appliance.

This product is designed as a domestic cooking appliance for the preparation and cooking of domestic food products, and should not be used for any other purpose.

- Remove all packaging from the appliance before using for the first time.
- Make sure you read and understand the instructions before using the appliance.
- Keep electrical leads short so they do not drape over the appliance or the edge of the worktop.
- Keep all flammable materials (such as curtains, furnishings & clothing) away from the appliance.
- Parts of the appliance may be hot during or immediately after use. Care should be taken to avoid touching heating elements inside the oven. Allow sufficient time for the appliance to cool after switching off.
- When opening the appliance door, take care to avoid skin contact with any steam which may escape from the cooking.
- Do not use foil on oven shelves or allow it to block the oven flue, as this creates a fire hazard, and prevents heat circulation.

- Do not drape tea towels over the flue vents as this creates a fire hazard.
- Do not use aluminium foil to cover the grill pan, or put items wrapped in foil under the grill, as this creates a fire hazard.
- Use oven gloves when removing hot food / dishes from the oven or grill. The oven / grill and utensils will be very hot when in use.
- When cooking heavy items - eg; turkeys - do not pull the oven shelf out with the item still on the shelf.
- Do not place items on the oven door when it is open.
- The storage compartment should only be used to store oven furniture. Do not store any flammable materials in these compartments.
- Never use the appliance for heating a room.
- All installation, servicing and maintenance work should be carried out by a competent person who will comply with current Regulations, Standards and Requirements.
- As with all gas appliances, it is recommended that your appliance is serviced regularly.

When you have finished cooking check that all controls are in the off position.

OVEN & GRILL FUNCTIONS

Fascia symbols

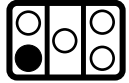

auxiliary burner

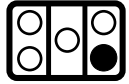

semi-rapid burner

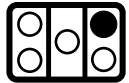

semi-rapid burner

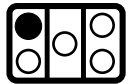

rapid burner

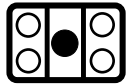

wok burner



oven temperature control



selector control



grill control



oven light switch



hotplate ignition switch

INSTALLATION INSTRUCTIONS

Step 2: Connect to the gas supply

The inlet to the cooker is ½" BSP internal situated at the rear centre.

Use a 900mm - 1125mm length of flexible connector.

Natural Gas - Flexible connections should comply with BS669. Parts of the appliance likely to come into contact with a flexible connector have a temperature rise of less than 70°C.

LP Gas - For flexible connections, use a bayonet type hose, suitable for use on LP Gas up to 50 mbar pressure rise and 70°C temperature rise. The flexible hose should be coloured black with a red stripe, band or label. If in doubt, contact your supplier.

After installation, make sure all connections are gas sound

INSTALLATION INSTRUCTIONS

Stability bracket

If the cooker is fitted with a flexible connection, a stability bracket should be fitted to engage in the back of the cooker. A stability bracket can be bought from your local supplier.

A stability bracket can be fitted as follows:

1. Place the cooker in position and draw a PENCIL LINE level with the front edge.
2. Mark the centre of the cooker to give the CENTRE LINE for the bracket.
3. Remove the cooker and mark off 450mm from the PENCIL LINE to locate the front edge of the lower bracket.

4. Fix the bracket to the floor.
Measure from floor level to engagement edge in the back of the cooker and add 3mm.
5. Assemble the underside of the top part of the bracket to this height.

Levelling

Place a spirit level on a baking sheet onto an oven shelf.

The cooker is fitted with levelling feet and locknuts at the front, and wheels at the rear.

Adjustment of wheel height can be made with a screwdriver through the hexagonal hole in the front plinth.

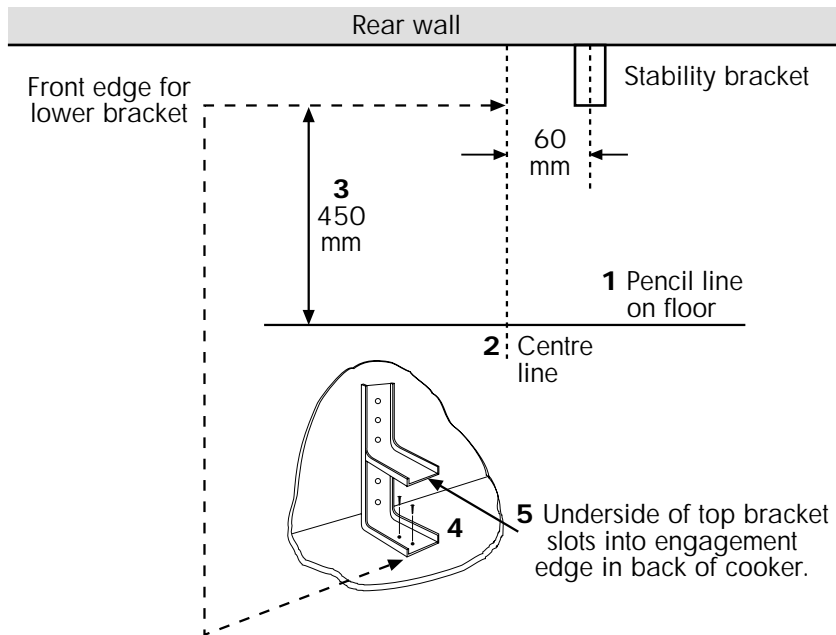

OVEN & GRILL FUNCTIONS

Symbol	Function / Feature	
	Conventional Grill	page 13
	Fanned Grill	page 13
	Defrosting and cooling	page 16
	Conventional Oven	page 16
	Top Heat Only	page 16
	Base Heat Only	page 16
	Fanned Oven	page 16
	Fan and Base Heat Only	page 16
	Intensive Bake	page 16

STORAGE COMPARTMENT

Your appliance has a generous pan drawer located beneath the oven.

The bottom of the storage compartment is lined with a rubber mat.

The storage compartments should only be used to store oven furniture.

Baking trays and roasting tins may be stored in the compartment.

Do not store items with plastic or wooden handles in the compartment, as they may be damaged by heat from the oven.

Do not store flammable liquids, even when cold, in the storage compartment, as they may catch fire. Do not store flammable items, ie; chip pans.

Do not store food / canned items in the storage compartment. **Do not use the compartment as a food warming facility.**

INSTALLATION INSTRUCTIONS

Step 1: Prepare installation

Important: ensure that you route all mains and electrical cables and flexible tubing well clear of any adjacent heat source.

Ensure that all pipework is of the correct rating for both size and temperature.

This cooker may be fitted flush to base units.

Clearances

No shelf or overhang or cooker hood shall be closer than a minimum of 650mm, but check with cooker hood manufacturer's recommendations.

Check that there are no projections in the rear wall which will prevent the lid being raised to the vertical position.

The cooker must have a side clearance above hob level of 90mm up to a height of 400mm.

Whilst every care is taken to eliminate burrs and raw edges from this product, please take care when handling - we recommend the use of protective gloves during installation.

Moving the cooker

Please note that the weight of this appliance is approximately **95kg** (unpacked). Take care if the appliance needs to be lifted during installation - always use an appropriate method of lifting.

Do not attempt to move the cooker by pulling on the doors or handles. Open the door and grasp the frame of the cooker, taking care that the door does not shut on your fingers.

Take care to avoid damage to soft or uneven floor coverings when moving the appliance. Some cushioned vinyl floor coverings may not be designed to withstand sliding appliances without marking or damage.

Appliance dimensions

All sizes are nominal, and some variation is to be expected. The 'depth' of the cooker, as given below, is to the front of the door and excluding knobs and handles.

Width	900mm
Depth	600mm
Height	900mm

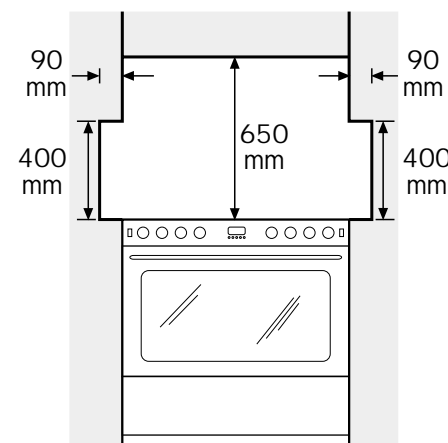

INSTALLATION INSTRUCTIONS

Before you start: Please read the instructions. Planning your installation will save you time and effort.

Prior to installation, ensure that the local distribution conditions (nature of the gas and gas pressure) and the adjustment of the appliance are compatible. The adjustment conditions are stated on the data badge.

This appliance is not connected to a combustion evacuation device. It shall be installed and connected in accordance with current installation regulation. Particular attention shall be given to the relevant requirements regarding ventilation.

In your own interest and that of safety, it is the law that all gas appliances be installed and serviced by competent persons. CORGI registered installers undertake to work to satisfactory standards.

Where regulations or standards have been revised since this handbook was printed, always use the latest edition.

In the UK the regulations and standards are as follows:

1. Gas Safety Regulations 1996 (Installation and Use).
2. Building Regulations - Issued by the Department of the Environment.
3. Building Standards (Scotland) (Consolidated) - Issued by the Scottish Development Department.
4. The current I.E.E. Wiring Regulations.
5. Electricity at Work Regulations 1989.
6. BS 6172 Installation of Domestic Gas cooking Appliances
Also, for **LP Gas**, refer to BS 5482 Part 1, Part 2 or part 3 as relevant.
7. Installation & Servicing Instructions for this appliance.

For installation in countries other than the UK, the appliance must be connected in accordance with all local gas and electrical regulations. In the Republic of Ireland, Installers should refer to IS813 Domestic Gas Appliances.

Ventilation Requirements

The room containing the appliance should have an air supply in accordance with BS 5440: Part 2: 1989:

- All rooms require an openable window, or equivalent, and some rooms will require a permanent vent as well.
- For room volumes up to 5m³ an air vent of 100cm² is required.
- If the room has a door that opens directly to the outside, or the room exceeds 10m³, NO AIR VENT is required.
- For room volumes between 5m³ and 10m³ an air vent of 50cm² is required.
- If there are other fuel burning appliances in the same room, BS 5440: Part 2: 1989 should be consulted to determine the air vent requirements.
- This appliance must not be installed in a bed sitting room of less than 20m³ or in a bathroom or shower room.

Windows and permanent vents should therefore not be blocked or removed without first consulting a CORGI gas installer.



LP Gas only - Do not install this appliance in a room below ground level. This does not preclude installation into rooms which are basements with respect to one side of the building, but open to ground level on the opposite side.

In the Republic of Ireland, refer to relevant Irish Standards for correct ventilation requirements.

Failure to install appliances correctly is dangerous and could lead to prosecution.

USING THE HOB

Ignition

Push in and turn the selected control knob anticlockwise to the 'full on' (large flame)  position and press the *ignition switch*  until the burner lights. Turn the control knob to the required setting.

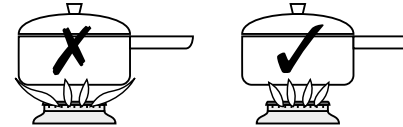

Adjust the burner flame so that it does not extend over the pan base.



To turn off, push in the control knob and turn clockwise until the dot on the control knob is below the dot on the fascia panel.

To simmer

The simmer position is marked by the small flame  symbol.

Once lit turn the selected control knob anticlockwise past the  large flame symbol (full on) to the  small flame symbol.

You may hear a slight popping noise when the hob burners are operating and this is quite normal, but if anything about the cooker appears unusual, such as change in flame appearance, or the operation of controls - seek expert advice.

Pans

Use flat based pans which are stable in use - refer to the table on the following page for pan sizes.

Do not use double pans, rim based pans, old misshapen pans or any pan which is unstable when placed on a flat surface.

Position pans over the centre of the burners, resting on the pan supports. If positioned off centre, smaller pans may be unstable.

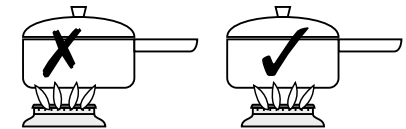

When cooking with fat or oil, never leave unattended.

Turn pan handles to a safe position, so they are out of reach of children, not overhanging the appliance, and cannot be caught accidentally.

Commercial simmering aids should not be used as they create excessive temperatures that can damage the surface and may cause a hazard.

When using woks with rounded bases, the wok stand should be used.

Do not use pans which overhang the pan supports.

USING THE HOB

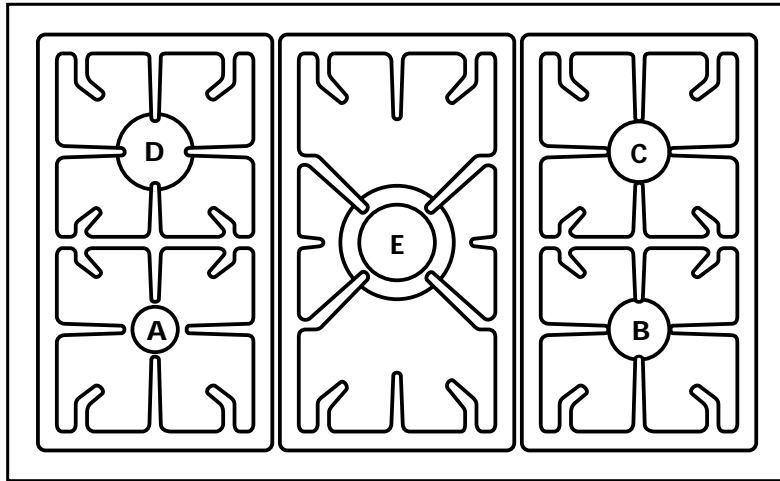

Burner	Pan base diameter		suitable for:
	min. mm	max. mm	
A Auxiliary	100mm	300mm	<i>Simmering, stewing, smaller pans.</i>
B Semi-rapid	100mm	300mm	<i>General domestic use, fish kettles, chip pans, griddle cooking.</i>
C Semi-rapid	100mm	300mm	<i>General domestic use, fish kettles, chip pans, griddle cooking.</i>
D Rapid	150mm	320mm	<i>Boiling, frying, larger pans.</i>
E Wok	180mm	320mm	<i>Wok cooking, larger pans.</i>

Notes:

Be careful when cooking foods in salted water, or foods containing large amounts of sugar or syrup, if they are spilt onto the stainless steel they may damage it.

Spillages should not be allowed to collect in the hotplate spillage well.

Wipe any spillage immediately - switch off the burners, move any pans out of the way and take care to avoid skin contact with hot surfaces.

If a Stoves griddle is used on the hotplate, it should only be used over the two semi-rapid burners **B** and **C**. Refer to the section "Using the Griddle". Only use the griddle which has been designed for use on this appliance.

CLEANING

Burner caps and heads

Important: Allow burners to cool before cleaning.

Caution: Hotplate burners can be damaged by soaking, automatic dishwashers (or dishwasher powders / liquids), caustic pastes, hard implements, coarse wire wool, and abrasive cleaning pastes.

For the burners to work safely, the slots in the burner head where the flames burn need to be kept clear of deposit. Clean with a nylon brush, rinse, and dry thoroughly.

Clean with a moist soapy pad - eg: "Brillo".

Any brownish coloured marks on the burners are carbon deposits or fat stains, which can be removed by rubbing gently with a moistened soapy "Brillo" pad.

Important: The burner caps and heads must be repositioned correctly so that they sit squarely onto the hob as shown below.

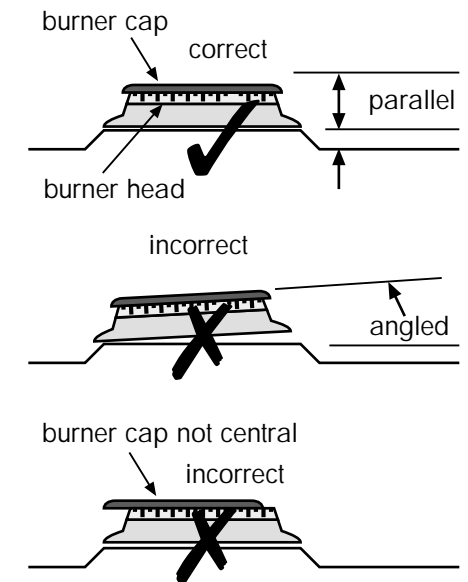

CLEANING

Glass parts

GLASS DOOR PANELS

Only use a clean cloth wrung out in hot soapy water. Rinse away excess cleaner and dry with a soft cloth.

Do not use abrasives or polishes as they will scratch and damage the glass.

The oven door inner glass panel can be removed for cleaning by grasping the top and bottom edges and sliding out.

Griddle care and cleaning

(if supplied)

Do not use metal implements as they may damage the non stick surface.

After cooking allow the griddle to cool completely before attempting to remove or clean.

Once the griddle has cooled, remove any excess fat with kitchen paper before moving.

The griddle can be cleaned with hot soapy water and a nylon brush. If any food residue is left on the griddle, leave it to soak for a few minutes in hot soapy water before attempting to clean it. **Do not** use caustic pastes, abrasive cleaning powders, coarse wire wool or any hard implements, as they will damage the surface.

Do not clean in a dishwasher.

After cleaning, dry thoroughly and store in a dry place.

Stainless steel surfaces

FASCIA PANEL, DOOR HANDLE, HOB SPILLAGE WELL, OVEN SIDES, DOOR

Only use a clean cloth wrung out in hot soapy water, and dry with a soft cloth.

Stubborn marks can be removed using "Luneta". We recommend that you clean the whole of the stainless steel area to maintain a uniform finish. Supplies can be purchased from the Customer Care Centre.

Do not use undiluted bleach or any products containing chlorides as they can permanently damage the steel.

Extra care should be taken when cooking food in salted water. Some foods are corrosive - eg; vinegar, fruit juices and especially salt - they can mark or damage stainless steel if they are left on the surface. Wipe any spillage immediately, taking care to avoid burning your hands.

Sharp objects can mark the surface of stainless steel, but will become less noticeable with time.

To maintain the finish of the stainless steel, or to remove any greasy marks, rub the stainless steel surface sparingly with a minimum amount of "Johnson's Baby Oil".

Do not use cooking oils, as these may contain salt which can damage the stainless steel surface.

HOTPLATE ACCESSORIES (if fitted)

The griddle and wok stand are available as optional extras.

Griddle (if supplied)

Only use the Stoves griddle which has been approved for use on this appliance - do not use any other griddle.

The griddle has a non stick cooking surface. Please read these instructions thoroughly before using the griddle for the first time. Refer to the cleaning section for instructions on care and cleaning.

For instructions on griddle cooking, please refer to the accompanying cooking guide.

Using the griddle

The griddle should only be used over the two semi-rapid burners on the right hand side of the hotplate.

Place the griddle centrally on the pan support over the burners.

Preheat the griddle for 3 minutes on full rate, which is indicated on the control knob by a 🔥 large flame symbol. After preheating, turn the control knobs to the 🔥 small flame symbol. The griddle is now ready for cooking.

After cooking, allow the griddle to cool before cleaning or moving it.

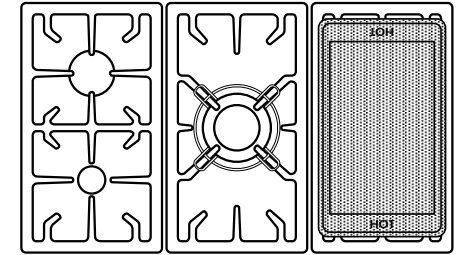

Wok stand (if supplied)

Woks with flattened bases can be placed directly onto the pan supports. The wok stand is designed for use with round-bottomed woks, to provide extra stability and ease of use.

Place the wok stand on the pan support over the central wok burner.

Place your wok on the stand to cook.

USING THE GRILL

Caution: Accessible parts may be hot when the grill is used, young children should be kept away.

Using the grill

Note: The grill will only operate with the oven temperature control in the "OFF" position.

Open the oven door.

Turn the selector control knob to the required grill setting (☐ conventional grill or ☑ fanned grill).

Turn the grill control knob to the desired setting.

The grill is fully variable - turn the grill control clockwise to use the full grill settings, or anticlockwise to use the single grill settings.

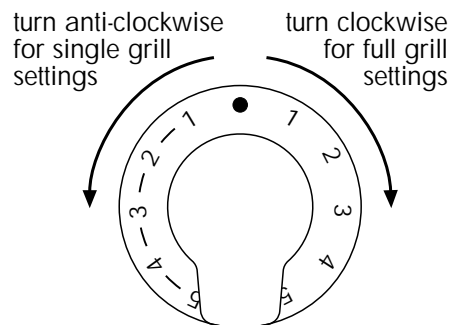

The grill trivet, inside the grill pan, can be inverted to give a high or low position, or it may be removed altogether.

For toasting, use the highest trivet position. The lower positions are useful for grilling meat or fish.

To switch off, return the controls to the "off" setting.

Note: The grill will only operate with the oven temperature control in the "OFF" position.

Cooling fan

When the grill is switched on, you will hear the cooling fan come on; this keeps the fascia panel cool during cooking and will continue to operate to cool the appliance for up to 10 minutes after the last control has been switched off.

Preheating

For best cooked results, the grill should always be preheated for about 3 minutes.

Aluminium foil

Using aluminium foil to cover the grill pan, or putting items wrapped in foil under the grill creates a fire hazard, and the high reflectivity can damage the grill element.

CLEANING

Caution: Any cleaning agent used incorrectly may damage the appliance.

Always let the cooker cool before cleaning.

Some cooking operations generate considerable amount of grease, this combined with spillage can become a hazard if allowed to accumulate on the appliance through lack of cleaning. In extreme cases this may amount to misuse of the appliance and could invalidate your guarantee.

It is recommended that the appliance is cleaned after open roasting.

Do not use caustic, corrosive or abrasive cleaning products, products containing bleach, coarse wire wool or any hard implements, as they will damage the surfaces.

All parts of the cooker can be safely cleaned with a cloth wrung out in hot soapy water.

Chrome plated parts

OVEN SHELVES & OVEN SHELF RUNNERS, GRILL PAN TRIVET, WOK STAND (if supplied)
Use a moist soap pad - eg; "Brillo".

Oven shelf runners can be removed for cleaning. Grasp the runners and slide out of the hanging holes as shown.

Note: These items may also be cleaned in a dishwasher.

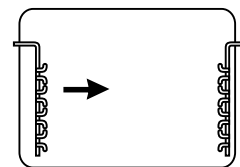

Vitreous Enamel Parts

GRILL PAN, PAN SUPPORTS, OVEN COMPARTMENT FLOOR

Use a mild cream cleaner - eg; "Cif".

Stubborn marks may be removed with a moistened "Brillo" pad.

The grill pan and pan supports may be cleaned in a dishwasher, or with a nylon brush in hot soapy water.

Easy care surfaces

OVEN SIDES AND BACK

We recommend that the appliance is cleaned after open roasting, and also after roasting at temperatures higher than 200°C, to help prevent a build up of fats. Use of a trivet in a roasting tin when roasting will help reduce fat splashing.

Caution: Most types of cleaning agent will damage these surfaces.

Only use a few drops of washing up liquid in hot water. Wipe the surfaces with a clean cloth wrung out in hot soapy water - if larger splashes of fat do not readily disappear, scrub the area with a nylon brush or nylon pan scourer and hot soapy water. Rinse well and heat the oven to dry the surfaces.

Painted & plastic parts (where fitted)

CONTROL KNOBS, PROGRAMMER BUTTONS

Only use a clean cloth wrung out in hot soapy water.

PROGRAMMER / CLOCK

The oven will automatically switch off at 18.00 hours (6.00 pm) and the alarm will sound (9).

9. A (Auto) symbol will flash.

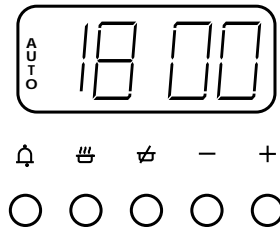

To switch off the alarm press the *minute minder* button (10).

10.

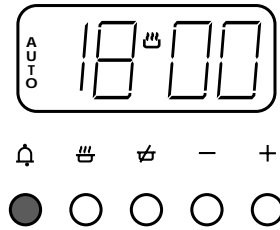

When the oven has switched off, **return the oven control knob to the "off" position**, and press the *cook time* and *ready time* buttons simultaneously (11).

11. A (Auto) symbol goes out.

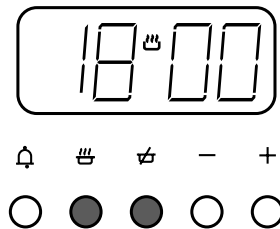

If you wish to cancel the automatic setting before cooking has started, and return to manual operation, press the *cook time* and *ready time* buttons simultaneously (11).

To cancel any remaining cooking time left on the clock before the alarm sounds, press the *cook time* and *ready time* buttons simultaneously (11).

USING THE GRILL

Conventional grill

The door must be open when the conventional grill is used.

- (i) Turn the selector control knob to the  conventional grill setting.
- (ii) Turn the grill control knob to select the required grill setting.

Fanned grill

The door must be closed when the fanned grill is used.

When opening the door, take care to avoid skin contact with any steam which may escape from the cooking.

- (i) Turn the selector control knob to the  fan grill setting.
- (ii) Turn the grill control knob to the required grill setting.

Fanned grilling may be faster than conventional grilling because air is being circulated around the food. Thin portions of food, such as bacon or fish fillets, may not need turning.

Detachable grill pan handle

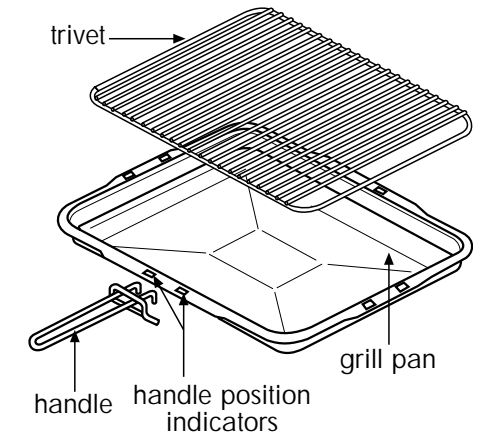

Place the handle over the edge of the grill pan, at the narrow side edges. Slide the handle to the centre, and locate between the handle position indicators.

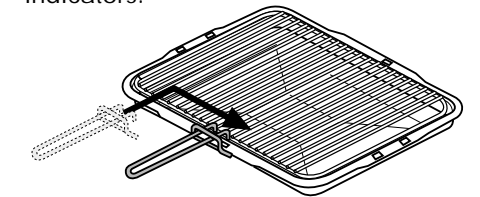

The handle should be removed from the pan during grilling, to prevent overheating.

The handle is designed for removing / inserting the grill pan under the grill when grilling.

If cleaning the grill pan when it is hot, use oven gloves to move it. *Do not* use the handle to pour hot fats from the grill pan.

Food for grilling should be positioned centrally on the trivet.

USING THE OVEN

Caution: Accessible parts may be hot when the oven is used. Young children should be kept away.

To use the oven

The oven is fully programmable. The programmer must be set to manual operation before the oven or grill can be used manually. See 'Programmer / Clock' section.

Select the function: Turn the selector control knob in either direction, until the function you require aligns with the marking on the fascia.

Set the oven control: If you have selected an oven function, simply turn the oven control knob clockwise to the required temperature - this brings on the red thermostat indicator neon, which will stay on until the oven reaches the required temperature.

To turn off, turn the control knobs until to the "off" position.

Automatic operation

See 'Programmer / Clock' section. Refer to the Cooking Guide for instructions on Automatic Cooking.

Red thermostat indicator neon

The red thermostat indicator neon will come on until the selected temperature is reached, and then go off. It will turn on and off periodically as the thermostat operates to maintain oven temperature.

Cooling fan

When the oven is switched on, you will hear the cooling fan come on; this keeps the fascia panel cool during cooking and will continue to operate to cool the appliance for up to 10 minutes after the last control has been switched off.

Oven lights

To switch on the oven lights, press the oven light switch at the left-hand side of the fascia.

PROGRAMMER / CLOCK

Fully automatic cooking (example)

For use when a delayed start time is required.

You want to set the length of cooking time, and the time for the oven to switch off. The programmer will automatically calculate the cooking start time.

Press the *cook time* button, then use the *plus* and *minus* buttons to set the display to show the length of cooking time required, eg; 2 hours as shown (5).

Press the *ready time* button, and the present ready time will be displayed. Using the *plus* and *minus* buttons you can set the display to show the actual time you want the oven to switch off, eg; 18.00 hours (6.00 pm) (6).

The display will revert to show time of day.

After setting the programmer, turn the oven control to the required temperature.

The oven will automatically switch on at the calculated start time of 16.00 hours (4.00 pm) (7).

A single press of the *cook time* button shows the cooking time remaining before the oven automatically switches off (8).

5. A (Auto) symbol appears.

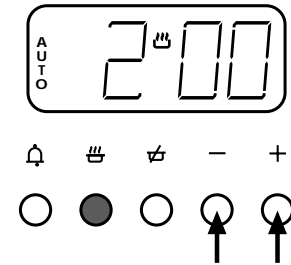

6. The cookpot symbol will disappear from display.

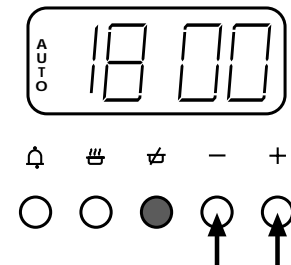

7. The cookpot symbol will appear on display.

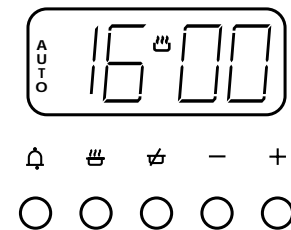

8.

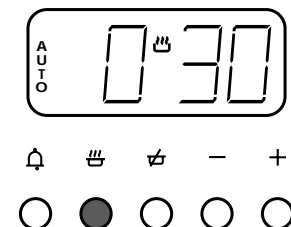

PROGRAMMER / CLOCK

Semi-automatic cooking (example)

You have started cooking a meal or dish in the oven, and want to set the time for the oven to switch off.

Press the *cook time* button, then use the *plus* and *minus* buttons to set the display to show the length of cooking time required, eg; 2 hours as shown (1).

After setting, the display will revert to show the time of day, but you can press the *cook time* button and the display will show how much cooking time still remains on the clock.

Press the *ready time* button, and the display will show the actual time the oven is going to switch off, eg; 18.00 as shown (2).

At the end of the cooking time, the alarm will sound, and the oven will automatically switch off.

To switch off the alarm, press the *minute minder* button (3).

When the oven has switched off, **return the oven control knob to the "off" position**, and press the *cook time* and *ready time* buttons to return to manual operation (4).

If you wish to cancel the automatic setting, or to cancel any remaining cooking time left on the clock before the alarm sounds, press the *cook time* and *ready time* buttons simultaneously. (4).

1. A (Auto) symbol appears.

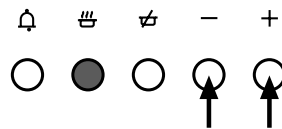

2.

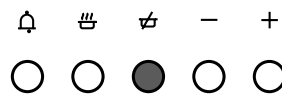

3. A (Auto) symbol will flash.

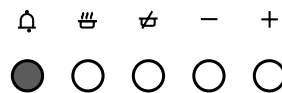
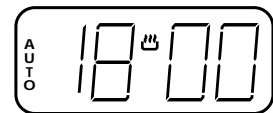

4. A (Auto) symbol goes out.

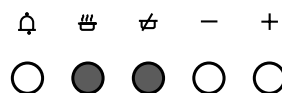
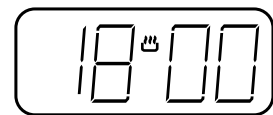

USING THE OVEN

Caution: The top oven element gets extremely hot when in use, so please take extra care to avoid touching it.

Preheating

Always use the fan oven setting for preheating to save time and electricity.

After the oven has been preheated on the fan oven setting, turn the selector control knob to the oven setting you require.

The oven must be preheated when cooking frozen or chilled food, and we recommend preheating for yeast mixtures, batters, soufflés and whisked sponges, otherwise preheating is not necessary as a fan oven warms up quickly.

Preheat the oven until the indicator neon switches off for the first time; this will take between 5 - 15 minutes, depending on the temperature selected.

Baking tray and roasting tins

For best cooked results and even browning, the maximum size baking trays that should be used is 530mm x 310mm.

Oven shelves & shelf positions

The oven shelf must be positioned with the upstand at the rear of the oven and facing up.

Position baking trays and roasting tins on the middle of the shelves, and leave 1 clear shelf position between shelves, to allow for circulation of heat.

Extra shelves may be ordered from the Customer Care Centre.

Never put items directly on the base of the oven or cover the oven base with foil, as this can cause the base element to overheat.

USING THE OVEN

Defrosting and cooling

- (i) Turn the selector control knob to defrost .

To **defrost** frozen foods, place food in the centre of the oven and close the door.

To **cool** foods after cooking prior to refrigeration or freezing, place food in the centre of the oven with the door open.

Refer to the Cooking Guide for more information on using the Defrost function.

Conventional oven

- (i) Turn the selector control knob to the  conventional oven setting.
- (ii) Turn the oven control knob to the required temperature.

The temperature you select corresponds to the temperature in the middle of the oven.

The top heat comes from the outer element of the grill, and the base heat is under the oven base.

Top heat only

- (i) Turn the selector control knob to the  top heat symbol.
- (ii) Turn the oven control knob to the required temperature.

Base heat only

- (i) Turn the selector control knob to the  base heat symbol.
- (ii) Turn the oven control knob to the required temperature.

Fan oven

- (i) Turn the selector control knob to the  fan oven setting.
- (ii) Turn the oven control knob to the required temperature.

The fan oven comes on when the oven is switched on and circulates the air around the oven to give a fairly even temperature throughout the oven.

Fan and base heat only





- (i) Turn the selector control to the fan and  base heat setting.
- (ii) Turn the oven control knob to the required temperature.

Intensive bake

- (i) Turn the selector control to the intensive bake  setting.
- (ii) Turn the oven control knob to the required temperature.

PROGRAMMER / CLOCK

The Programmer Buttons

-  minute minder
-  cook time
-  ready time
-  minus
-  plus

To set the "Time of Day"

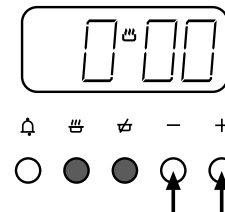

Press the *cook time* and *ready time* buttons simultaneously, and keep the buttons depressed. Use the *plus* and *minus* buttons to set the time of day, eg; 12.00.

A (Auto) symbol goes out, cookpot symbol comes on.

To select an alarm tone

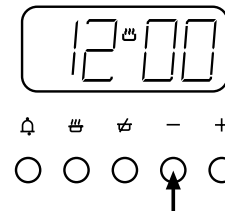

Press the *minus* button to listen to the first tone.

Release the *minus* button and press it again to listen to the second tone, etc.

Releasing the *minus* button after the tone has sounded will automatically select that tone.

Manual operation

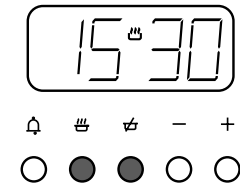

To set the programmer to manual operation at any time (cancelling any automatic setting), press the *cook time* and *ready time* buttons simultaneously. The programmer must be set to manual before the appliance can be used manually.

Setting the minute minder

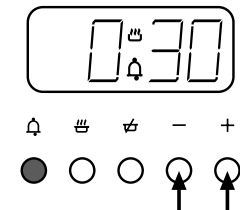

Press the *minute minder* button, then use the *plus* and *minus* buttons to set the required time.

The minute minder (bell) symbol will appear on the display.

You can cancel the minute minder at any time by pressing the *minute minder* button and the *minus* button until the display returns to 0.00.

After setting, the display will revert to show the time of day, but you can press the *minute minder* button, and the display will show the minutes remaining.

The tone will sound at the end of the time set - to cancel the tone, press the minute minder button.